

STEEL ROOF DECK CATALOG VR4

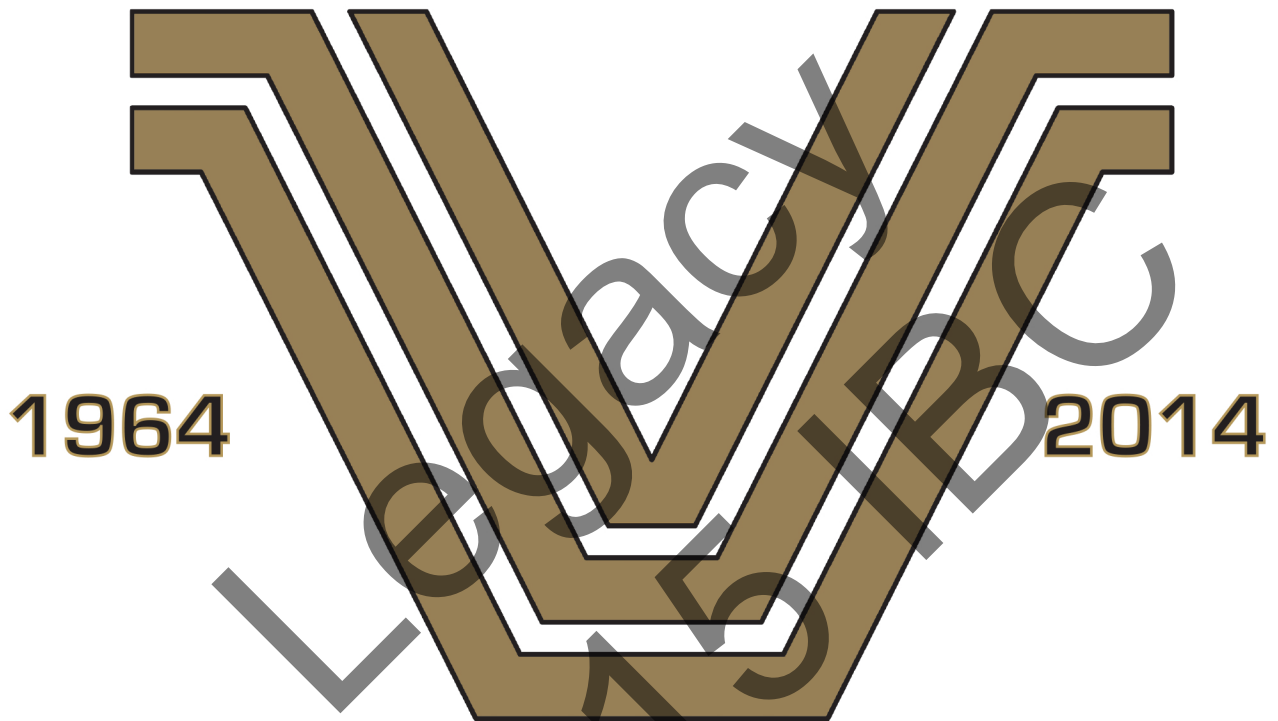

VERCO DECKING, INC.
a NUCOR company



Celebrating Fifty Years of Excellence

1964  2014

VERCO DECKING, INC.

HONORING THE PAST | CELEBRATING THE PRESENT | EMBRACING THE FUTURE

1964 HONORING OUR PAST

Since our start in 1964, testing has been a key to the innovative products Verco has introduced to the market:

- ShearTranz® System
- System 80
- FORMLOK™ System
- ShearTranz® II System
- PunchLok® System

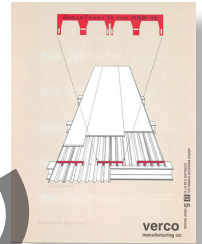

CELEBRATING THE PRESENT

Innovative high quality products combined with our teammates dedication to excellence and superior service are fundamental to Verco's success. We strive to be the deck supplier of choice by being the safest, most innovative and most productive steel deck company in the world.



2014 EMBRACING THE FUTURE

Verco is pleased to begin our second 50 years of service to the construction community with the introduction of the N3 roof and floor deck profiles and the PunchLok II System.

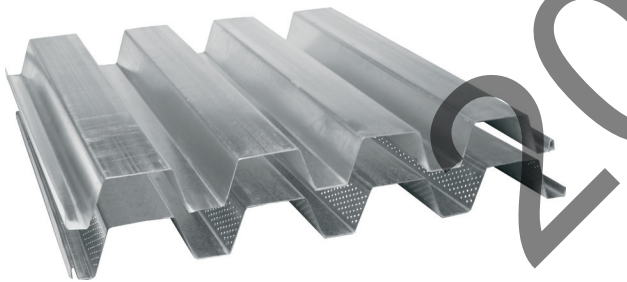

PLN3™/HSN3™/N3

The Verco N3 roof and floor deck profiles have a 32" cover width. This additional cover width results in fewer sheets to spread and less sidelaps to fasten. The N3 profile offers superb shear strength with fewer support and sidelap fasteners to install.



PUNCHLOK® II SYSTEM

Building on the success of the industry changing PunchLok System, the Verco PunchLok II System provides an even stronger sidelap connection with the same benefits of the original PunchLok System including simple visual inspection, consistency, and efficiency.

CATALOG CONTENTS

VERCO® PROFILES	2
TECHNICAL GUIDELINES.....	3
PLB™ and HSB® DECK.....	25
PLN3™ and HSN3™ DECK	79
PLN-24™ and N-24 DECK	103
CELLULAR ROOF DECK	123
VERCOR™ DECK.....	143
ACOUSTICAL, FM AND FIRE PROPERTIES	155

Legacy
2015 IBC

COMMON VERCOR® PROFILES



PLB™-36 and HSB®-36
1½" Deep, 36" Wide



PLB™-CD and HSB®-CD
1½" Deep, 36" Wide

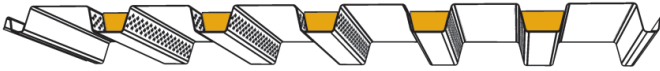

PLB™-36 AC and HSB®-36 AC
1½" Deep, 36" Wide

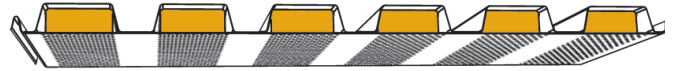

PLB™-CD AC and HSB®-CD AC
1½" Deep, 36" Wide



PLN3™ and HSN3™
3" Deep, 32" Wide

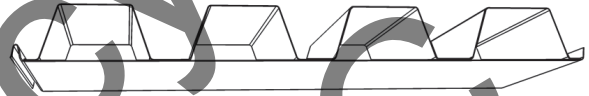

PLN3™-CD and HSN3™-CD
3" Deep, 32" Wide

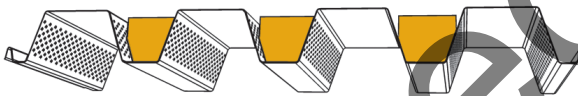

PLN3™ AC and HSN3™ AC
3" Deep, 32" Wide

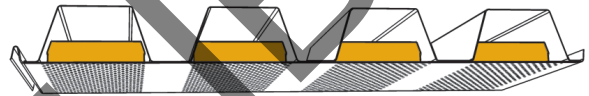

PLN3™-CD AC and HSN3™-CD AC
3" Deep, 32" Wide

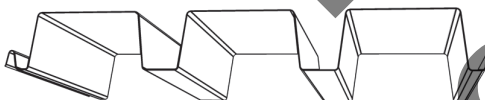

PLN™-24 and N-24
3" Deep, 24" Wide

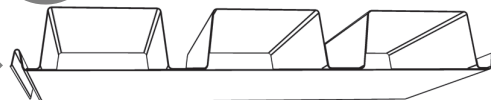

PLN™-24-CD and N-24-CD
3" Deep, 24" Wide

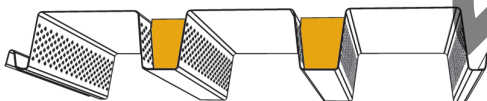

PLN™-24 AC and N-24 AC
3" Deep, 24" Wide

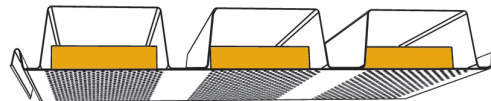

PLN™-24-CD AC and N-24-CD AC
3" Deep, 24" Wide



Shallow VERCOR™
9/16" Deep, 36" Wide



Deep VERCOR™
15/16" Deep, 36" Wide

Profile Designations	4
Material	4
Roof Deck Vertical Loads	5
Uniform Load Tables	5
Design Formulas	5
Bearing	5
Web Crippling: One vs. Two Flange Loading	6
Suspended Loads	7
Concentrated Loads	7
Cantilevered Deck	7
Wind Uplift	7
Allowable Tension Loads for Support Connections	8
Roof Deck Diaphragms	9
Diaphragm Load Tables	9
FORMLOK™ Deck Diaphragms	9
Axial Loads	9
Attachment of Roof Deck	10
Support Fastening	10
Welds	10
Hilti Fasteners	10
Pneutek Fasteners	10
Screws	11
ShearTranz® II-42 System	11
Sidelap Connections	12
PunchLok® II System	12
Top Seam Welds	13
Button Punches	13
Screws	13
Parallel Collectors	13
Fillet Welds	13
Allowable Shear Strength of Support Connections	14
Vercor Roof Deck Finishes	15
Galvanized	15
Cold Rolled with Primer	15
Galvanized with Primer	15
Exposed Product Appearance	15
Roof Deck Product Selection	16
Spans	16
Roofing	16
Vent Tabs	16
Roof Deck Design Example	17
Design Goals	17
Span Options	17
Diaphragm Attachment Options	17
Finish Options	20
Fire Ratings	20
Roof Deck Accessories	21
Profile Closures	21
Sump Pan	22
Specification Section 05 31 23 - Steel Roof Decking	22
Using the Tables	23
Acoustical, FM and Fire Properties	155
Metric (SI) Conversions	163

VERCO® ROOF DECK TECHNICAL GUIDELINES

Verco Decking, Inc. is noted for its innovative development of steel roof decks including the use of mechanical sidelap connections (the PunchLok Systems) and shear restraining elements (the ShearTranz Systems). In this catalog, Verco features a complete range of systems utilizing the PunchLok II System for sidelap connections: 1½" deep PLB-36, 3" deep PLN3 and 3" deep PLN-24 with welds and mechanical fasteners (power actuated fasteners and screws) to the supports, and PLB-36 deck with ShearTranz II-42. With the PunchLok II System, Verco continues its industry leading history of improvement and innovation to serve the construction community.

Profile Designations

Deck for PunchLok® II Systems:

- PLB-36, PLB-36 AC, PLB-CD, and PLB-CD AC
- PLN3, PLN3 AC, PLN3-CD, and PLN3-CD AC
- PLN-24, PLN-24 AC, PLN-24-CD, and PLN-24-CD AC

Deck for Button Punch and Top Seam Weld Sidelaps:

- HSB-36, HSB AC, HSB-CD, and HSB-CD AC
- HSN3, HSN3 AC, HSN3-CD, and HSN3-CD AC
- N-24, N-24 AC, N-24-CD, and N-24-CD AC

Deck for Screwed Sidelaps:

- HSB-36-SS and HSB-36-SS AC (Interlocking Screwed Sidelap)
- HSN3-SS and HSN3-SS AC (Interlocking Screwed Sidelap)
- HSN3-NS and HSN3-NS AC (Nestable Screwed Sidelap)
- N-24-SS and N-24-SS AC (Interlocking Screwed Sidelap)
- Shallow VERCOR (Nestable Screwed Sidelap)
- Deep VERCOR (Nestable Screwed Sidelap)

Material

Galvanized fluted roof deck panels are formed from either ASTM A 653 or A 1063 steel. Painted/painted or mill finished fluted roof deck panels are formed from either ASTM A 1008 or A 1039 steel.

Cellular roof deck sections are fabricated from galvanized steel conforming to ASTM A653 or A 1063. The fluted top and flat bottom sections are factory resistance-welded together.

Note: Weld marks will be visible on the exposed flat bottom.

Deep and Shallow VERCOR decks are fabricated from G90 galvanized steel conforming to ASTM A 653 or A 1063.

ROOF DECK VERTICAL LOADS

Uniform Load Tables

Allowable uniform load values are based on the allowable bending moment (stress) and limiting deflection to $L/360$, $L/240$ or $L/180$. Allowable uniform load values for cellular deck panels are also governed by the allowable vertical shear (governed by the horizontal shear strength of the resistance welds between the fluted top section and the flat bottom section). The symbol ♦♦♦ indicates that the allowable uniform load based on deflection exceeds the allowable load based on flexure (stress) or vertical shear (shear). Note that self-weight of the deck should be included when determining dead load.

The formulas used to determine the allowable uniform loads due to flexure (stress), shear and deflection are as follows:

Design Formulas

+M = Positive Bending Moment in ft-lb

-M = Negative Bending Moment in ft-lb

Δ = Deflection in inches

E = 29,500,000 psi

w = Allowable uniform live load in psf

L = Span length in feet. Span lengths shown in tables are center-to-center spans.

R_e = End reaction in lb/ft

R_i = Interior reaction in lb/ft

V_e = Vertical Shear adjacent to end support

V_i = Vertical Shear adjacent to interior support

Span	Bending Moment	Deflection	Bearing	Shear
Single	$+M = 0.125 \cdot w \cdot L^2$	$\Delta = \frac{0.013 \cdot w \cdot L^4 \cdot 1728}{E \cdot I}$	$R_e = 0.5 \cdot w \cdot L$	$V_e = 0.5 \cdot w \cdot L$
Double	$-M = 0.125 \cdot w \cdot L^2$	$\Delta = \frac{0.0054 \cdot w \cdot L^4 \cdot 1728}{E \cdot I}$	$R_e = 0.375 \cdot w \cdot L$ $R_i = 1.25 \cdot w \cdot L$	$V_e = 0.375 \cdot w \cdot L$ $V_i = 0.625 \cdot w \cdot L$
Triple	$-M = 0.1 \cdot w \cdot L^2$	$\Delta = \frac{0.0069 \cdot w \cdot L^4 \cdot 1728}{E \cdot I}$	$R_e = 0.4 \cdot w \cdot L$ $R_i = 1.1 \cdot w \cdot L$	$V_e = 0.4 \cdot w \cdot L$ $V_i = 0.6 \cdot w \cdot L$

Bearing

Verco recommends 2 inches minimum bearing on perpendicular supports. The required bearing should be verified based on specific load and span conditions. Adequate bearing at perpendicular supports is required to prevent web crippling of the deck and to allow for proper attachment. Sufficient bearing at parallel supports should be provided to make the specified connections.

The allowable reactions as well as allowable concentrated line loads based on web crippling (one and two flange loading) are shown in the section properties tables that follow in this catalog.

The following illustration (Figure 1) illustrates the difference between one flange and two flange loading for web crippling.

Web Crippling: One vs. Two Flange Loading

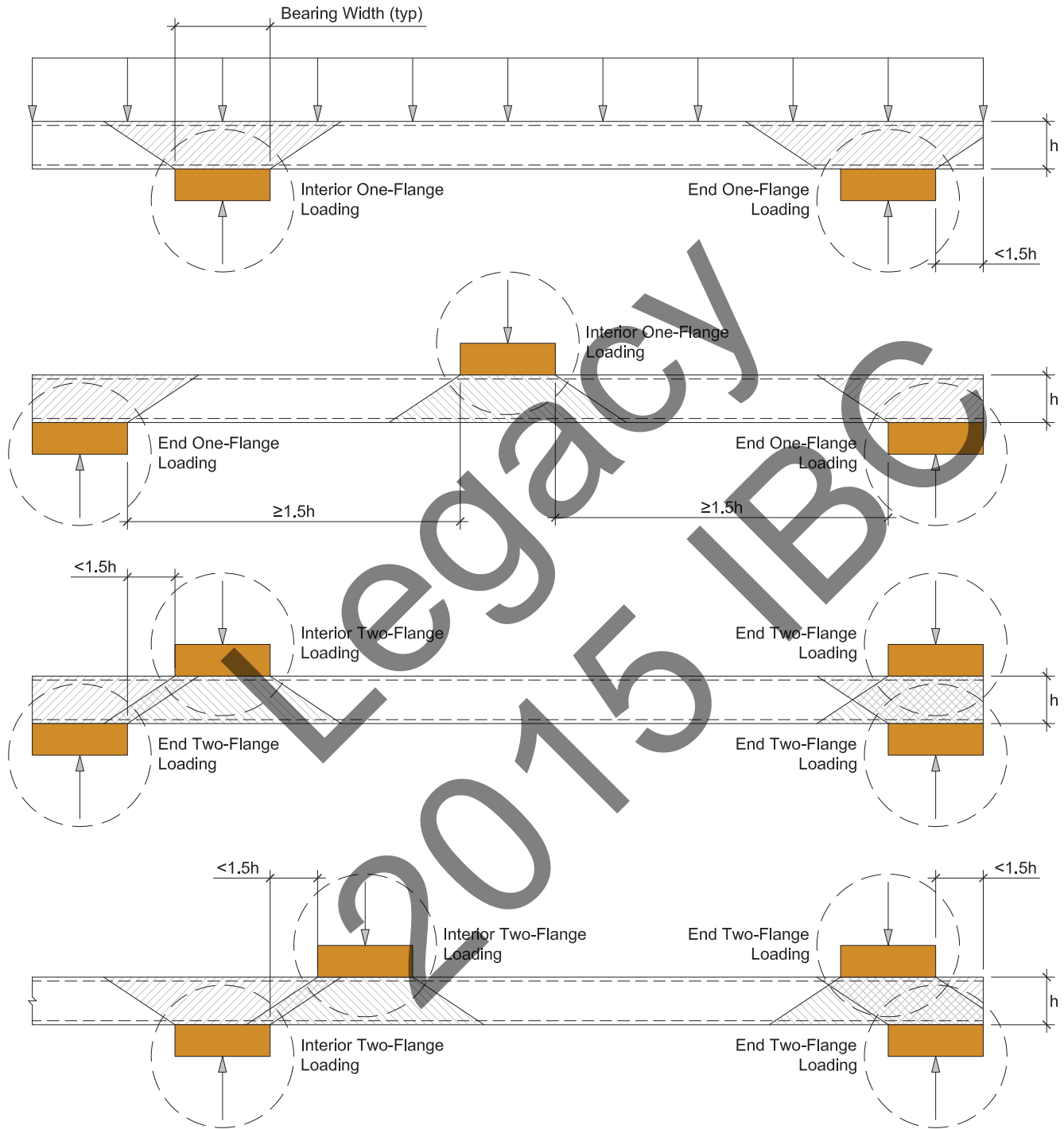

FIGURE 1

Suspended Loads

The engineer of record should evaluate suspended or hanging loads attached directly to the roof deck on the basis of the project conditions. The specific method of attachment will determine the load distribution or effective width of deck to be used in the evaluation.

Concentrated Loads

Concentrated loads, such as those due to construction or maintenance workers, should be evaluated based on the deck section properties, material strengths, and web crippling capacities.

Cantilevered Deck

The length of Verco roof deck cantilevers can be determined based on section properties and material strengths. Consider construction or maintenance workers and materials attached to the deck, particularly with regard to deflection. Attach cantilevers to supports prior to loading. See Figure 2.

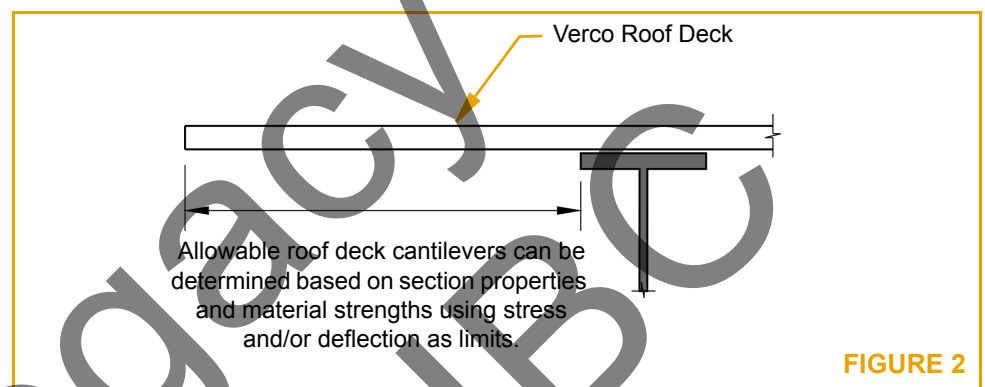

Wind Uplift

Determine allowable spans to resist uplift forces based on the deck section properties and material strengths. Evaluation may be warranted on specific projects.

Allowable tension strengths of arc spot welds and #12 screws are determined in accordance with AISI's "S100: North American Specification for the Design of Cold-Formed Steel Structural Members." (AISI S100).

Allowable tension strengths of Hilti and Pneutek fasteners are based on the specific combination of fastener, substrate thickness, and deck gage.

Allowable tension loads for arc spot welds, Hilti fasteners and Pneutek fasteners subject to wind uplift are listed in Table 1. Allowable tension loads for #12 screws subject to wind uplift are listed in Table 2.

Table 1: Allowable Tension Loads (lbs/connection) for Arc Spot Welds, Hilti Fasteners and Pneutek Fasteners Subject to Wind Uplift Loads for Verco B and N Steel Deck Panels

Gage	Profile	BMT	Arc Spot Weld	Hilti X-EDNK22 or X-HSN 24	Hilti X-ENP-19	Pneutek SDK61, SKD63, K64 or K66
		(in.)	(lbs)	(lbs)	(lbs)	(lbs)
22	B & N	0.0299	505	493	525	297
20	B & N	0.0359	602	592	631	429
18	B & N	0.0478	790	788	840	760
16	B & N	0.0598	975	985	1050	1190

Table 2: Allowable Tension Loads (lbs/connection) for #12 Screws Subject to Wind Uplift Loads for Verco Deck Panels

Gage	Profile	BMT (in.)	Support Thickness (in.) and Strength, F _y / F _u (ksi)											
			33 mil (0.0346 in.)		43 mil (0.0451 in.)		54 mil (0.0566 in.)		68 mil (0.0713 in.)		97 mil (0.1017 in.)		1/8 in.	≥3/16 in.
			33/45	50/65	33/45	50/65	33/45	50/65	33/45	50/65	33/45	50/65	36/58	36/58
26	SV	0.0179	95	138	124	173	156	173	173	173	173	173	173	173
	DV	0.0195	95	138	124	179	156	189	189	189	189	189	189	189
24	SV	0.0239	95	138	124	179	156	225	196	232	232	232	232	232
	DV	0.0254	95	138	124	179	156	225	196	246	246	246	246	246
22	SV	0.0299	95	138	124	179	156	225	196	284	280	290	290	290
	B & N	0.0299	95	138	124	179	156	225	196	284	280	290	290	290
20	DV	0.0314	95	138	124	179	156	225	196	284	280	304	304	304
	B & N	0.0359	95	138	124	179	156	225	196	284	280	348	348	348
18	DV	0.0374	95	138	124	179	156	225	196	284	280	362	362	362
	B & N	0.0478	95	138	124	179	156	225	196	284	280	405	444	463
16	B & N	0.0598	95	138	124	179	156	225	196	284	280	405	444	579

Notes for Tables 1 and 2:

- The profile designations used in this table apply to the profile families as summarized below:
 "SV" - Shallow VERCOR
 "DV" - Deep VERCOR
 "B" - PLB & HSB roof deck (including web perforated acoustical deck)
 "N" - PLN3, HSN3, HSN3-NS, PLN24 & N24 roof deck (including web perforated acoustical deck)
- Base metal thickness (BMT) = specified minimum uncoated base metal thickness used in design. Deck subject to thickness tolerances as described in Section A2.4 of AISI S100.
- The minimum arc spot weld effective fusion diameter, d_e , is 1/2 inch. The values for arc spot welds may be applied to arc seam weld with minimum effective fusion width, d_e , of 3/8 inch and minimum length is 1 inch excluding circular ends.
- Details, workmanship, technique and qualification of welds must comply with AWS D1.3.
- The Hilti fasteners are applicable to the following substrate thicknesses:
 X-EDNK22: 1/8 in. ≤ substrate thickness ≤ 1/4 in.
 X-HSN 24: 1/8 in. ≤ substrate thickness ≤ 3/8 in.
 X-ENP-19: substrate thickness ≥ 1/4 in.
- The Pneutek fasteners are applicable to the following substrate thicknesses:
 SDK61 series: 0.113 in. ≤ substrate thickness ≤ 0.155 in.
 SDK63 series: 0.155 in. ≤ substrate thickness ≤ 0.250 in.
 K64 series: 0.187 in. ≤ substrate thickness ≤ 0.312 in.
 K66 series: substrate thickness ≥ 0.281 in.
- The #12 screws are self-drilling self-tapping screws with a minimum washer diameter of 5/16-in. and a minimum washer thickness of 0.05 in. The screws must be compliant with ASTM C1513.
- The allowable tensile strength of the individual screws, as published by their manufacturer, must meet or exceed the allowable screw connection tensile strengths listed above.
- The strength is the ASD allowable connection tensile strength, where Ω is 2.5 for welds and 3.0 for Screws, Hilti and Pneutek fasteners. Convert ASD tensile strengths to LRFD based on $\phi = 0.60$ for welds and $\phi = 0.50$ for Screws, Hilti or Pneutek fasteners.

ROOF DECK DIAPHRAGMS

The allowable diaphragm shear values in the tables for Verco roof decks are based on attachment of the deck to the perpendicular supports with welds or mechanical fasteners. The attachment patterns for each profile are shown in the illustrations included with the tables.

Diaphragm Load Tables

Designers should observe the following notes when working with these tables:

- The shear strength for roof decks without concrete fill listed in this catalog are based on a continuous 3-span condition for span lengths 4 feet and greater. For spans less than 4 feet, the allowable diaphragm shear values are based on a sheet length of 12 feet or a maximum of 7 spans. For spans less than 4 feet, deck panels longer than 12 feet or with more than 7 spans may be used with the tabulated values.
- The allowable stress increase permitted for load combinations in IBC Section 1605.3.2, including wind or seismic forces, shall not be used for allowable diaphragm shears.
- The flexibility factor (F) is the number of microinches a diaphragm web will deflect in a span of 1 ft under a shear load of 1 pound per ft. Refer to Verco's Evaluation Report for guidance in calculating anticipated deflections using the flexibility factor, F .
- R is the vertical load span (spacing between supports) (L_V) of the deck divided by the length (L_S) of the deck sheet: $R = L_V / L_S$.
- See "Sidelap Connections" on page 12 for information regarding connection spacing.
- Deck panels may be butted or lapped. When deck panels are lapped, the minimum end lap length is 2 inches. See page 66 for lapped and butted end joint requirements when using the ShearTranz II-42 System.
- See additional footnotes for Diaphragm Shear Strength and Flexibility Factors listed in the following sections of this catalog.

FORMLOK™ Deck Diaphragms

Refer to Verco's Evaluation Report or Verco's Floor Deck Catalog for diaphragm values for PLW2-36, W2-36, PLW3-36, and W3-36 FORMLOK deck without concrete fill.

Axial Loads

Axial load strength of steel deck can be evaluated in accordance with AISI S100.

ATTACHMENT OF ROOF DECK

Support Fastening

The diaphragm shear tables of this catalog include two methods of attaching deck to the supports: welds and mechanical fasteners (power actuated fasteners or self-drilling, self-tapping screws).

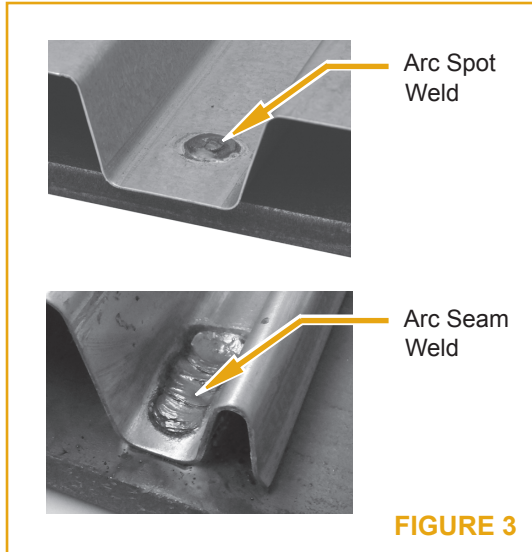

FIGURE 3

Welds: When Vercor roof deck is to be welded to supports, the effective fusion area is to be at least $\frac{1}{2}$ in. diameter for arc spot (puddle) welds (Figure 3) or at least $\frac{3}{8}$ in. x 1 in. long for arc seam welds. Arc seam and arc spot welds are to be located and spaced as described in the tables.

Hilti Fasteners: Hilti X-EDNK22 THQ12, X-HSN 24, or X-ENP-19 L15 fasteners are to be installed as shown in Figure 4. Hilti X-HSN 24 fasteners have a dome style head, red guidance washer and a steel silver-colored top-hat washer. Hilti X-EDNK22 fasteners have a dome style head, a $\frac{15}{32}$ inch diameter steel flat washer, and a steel top hat washer. The Hilti X-ENP-19 fastener has a fully knurled tip and tapered shank fitted with two 0.590 inch diameter steel cupped washers. Contact Hilti for additional information on the fasteners.

Proper penetration of the Hilti fasteners into structural supports is shown in Figure 4. Fasteners shall be located not less than 1 in. from the end of the sheets.

Select the appropriate fastener based on the actual substrate thickness.

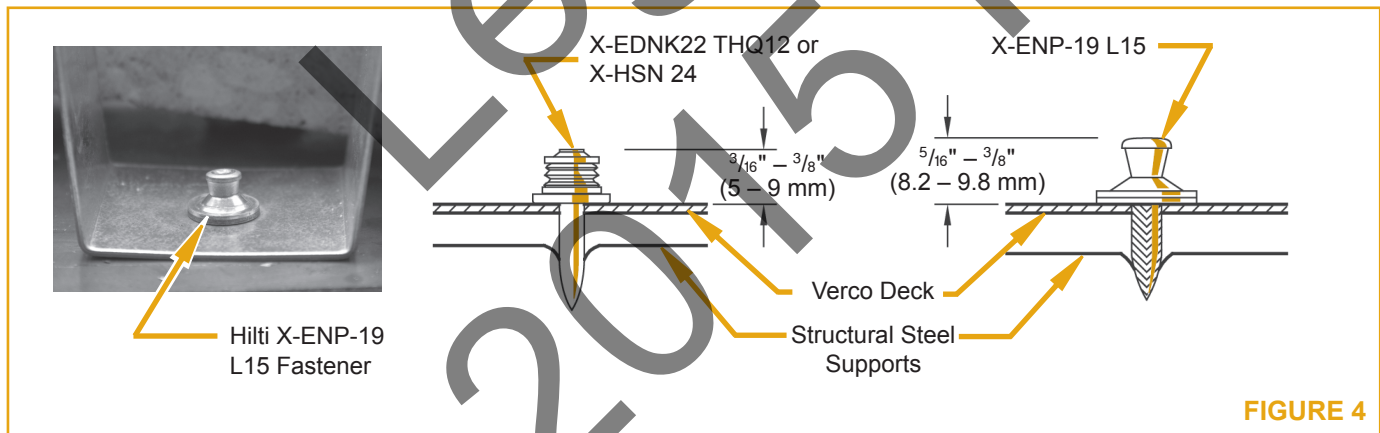

FIGURE 4

Pneutek Fasteners: Pneutek K66062, K66075, K64062, K64075, SDK63075, or SDK61075 fasteners are to be installed as shown in Figure 5. The Pneutek fasteners have $\frac{1}{2}$ inch diameter heads. Contact Pneutek for additional information on the fasteners.

Fasteners must be driven with the Pneutek Air/Safe fastening system to ensure tight contact between the fastener head and the attached deck as shown in Figure 5. Fasteners shall be located not less than 1 in. from the end of the sheets.

Select the appropriate fastener based on the actual substrate thickness. Note that K66075 or K64075 pins are to be used for attachment of four layers of 20 gage deck or three or four layers of 18 or 16 gage deck.

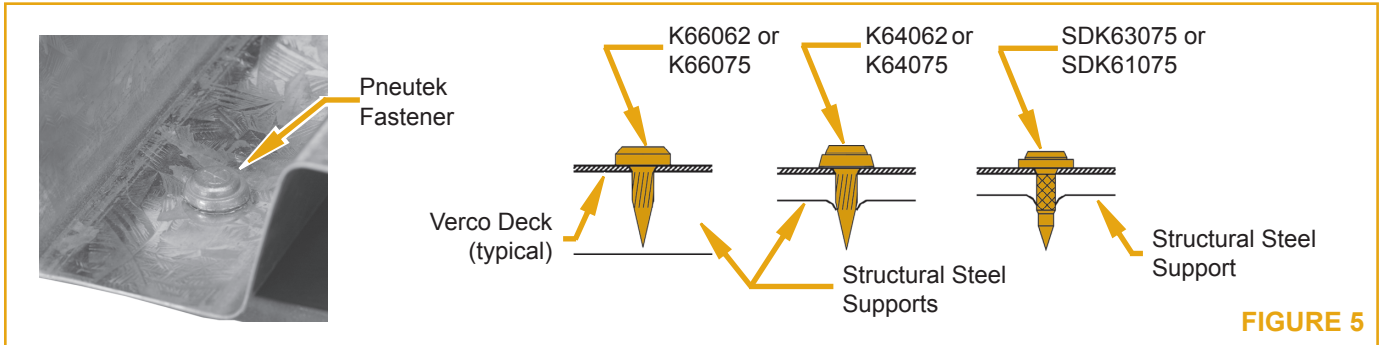

FIGURE 5

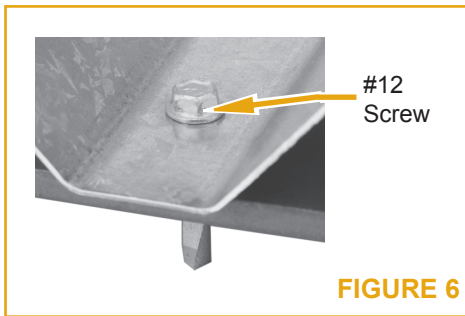

FIGURE 6

Screws: #12 self-drilling, self-tapping screws are to be installed as shown in Figure 6.

Diaphragm shear and flexibility values are based on SDI recognized #12 screws from Buildex, Elco, Hilti, and Simpson Strong-Tie when installed in supports at least 0.0385 inches thick. The tabulated shears and flexibility values may be modified in accordance with appropriate footnotes of the Diaphragm Shear Strength and Flexibility Tables for supports of different thicknesses or for screws (“generic”) which are not recognized by SDI.

ShearTranz® II-42 System: Verco introduced the use of restraining elements, such as the ShearTranz II-42 System, to increase roof deck diaphragm rigidity.

The 14 gage ShearTranz II-42 elements are used with PLB-36 deck with sidelaps connected using the PunchLok II Tool.

The ShearTranz II-42 elements are used at shear collecting support elements perpendicular to the deck corrugations. When ShearTranz II-42 elements are used, the deck does not need to terminate at the support as it may be cantilevered.

Deck end laps of PLB-36 with the ShearTranz II-42 System must be at least 2 inches and fastened to supports with arc spot and arc seam welds. ShearTranz II elements are required if butted end joints are used. See installation details shown on page 66.

Sidelap Connections

Verco roof decks are to be fastened at the sidelaps by one of four methods: VSC2s made with the PunchLok II Tool, 1½ in. long top seam welds, button punches, or #10 x ¼ in. long screws. Spacing of sidelap connections shall be as specified in the tables.

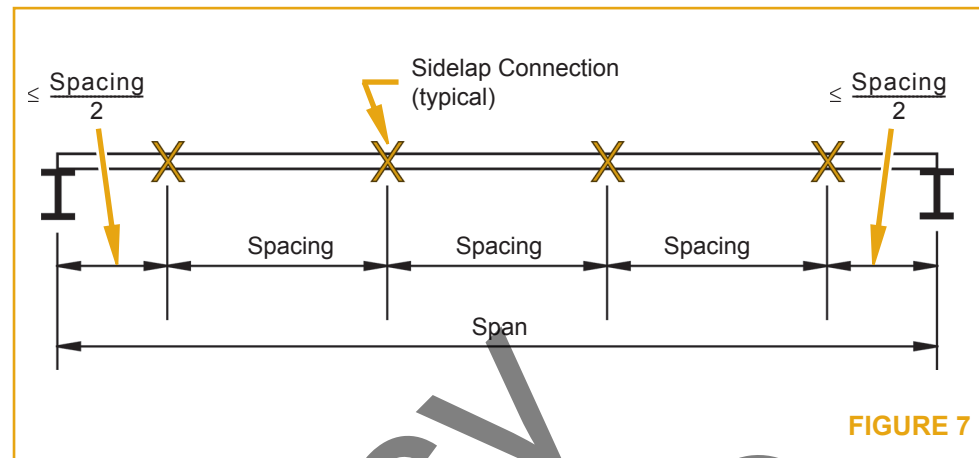

FIGURE 7

The dimension from the centerline of the supports to the first and last sidelap connection within each span is to be no more than one half the specified spacing as shown in Figure 7. The number of connections per span based on spacing are listed in Table 3.

Table 3: Number of Sidelap Connections per Span Based on Spacing

Spacing in inches	Span (ft.-in.)																			
	2'	3'	4'	5'	6'	7'	8'	9'	10'	11'	12'	13'	14'	15'	16'	17'	18'	19'	20'	
24"	1	2	2	3	3	4	4	5	5	6	6	7	7	8	8	9	9	10	10	
18"	2	2	3	4	4	5	6	6	7	8	8	9	10	10	11	12	12	13	14	
12"	2	3	4	5	6	7	8	9	10	11	12	13	14	15	16	17	18	19	20	
8"	3	5	6	8	9	11	12	14	15	17	18	20	21	23	24	26	27	29	30	
6"	4	6	8	10	12	14	16	18	20	22	24	26	28	30	32	34	36	38	40	
4"	6	9	12	15	18	21	24	27	30	33	36	39	42	45	48	51	54	57	60	

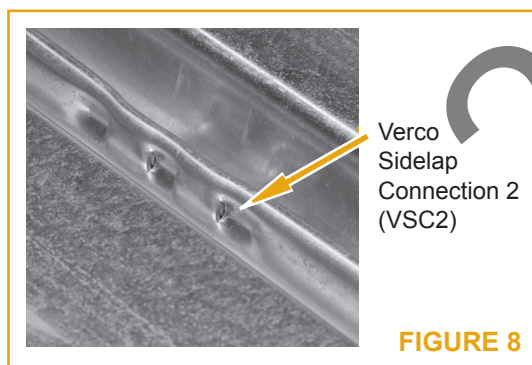
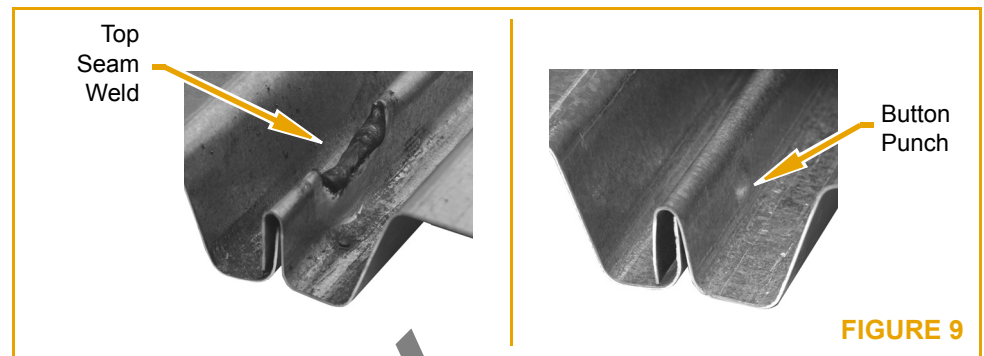

FIGURE 8

PunchLok® II System: The connection made by the PunchLok II Tool is referred to as a VSC2 (Verco Sidelap Connection 2). An acceptable VSC2 connection has been made when the sidelap material has been sheared and offset so the sheared surface of the male leg is visible in the cut (Figure 8).

The VSC2 connection may be made in either direction relative to the sidelap.

Top Seam Welds: When roof deck sidelaps are connected with top seam welds (TSW) (Figure 9, left), the 1½ in. long weld must engage the top of the inner (male) leg. Clinch the joint before welding to create contact between the lips.



Button Punches: When roof deck sidelaps are connected with button punches (Figure 9, right), an average-sized person should be able to stand (not jump) on the flute adjacent to the attachment without the joint coming apart.

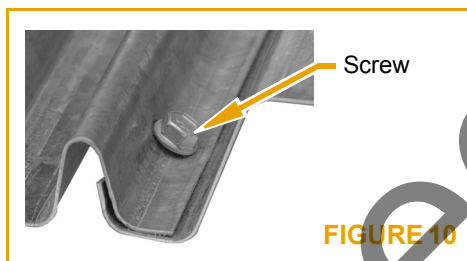

Screws: When self-drilling, self-tapping screws are used to connect the sidelaps of roof decks, they are installed as shown in Figure 10. The diaphragm shear values and flexibility factors shown in the tables of this catalog are based on minimum #10 self-drilling, self-tapping screws. The “SS” designation for roof deck indicates interlocking deck provided with extended female lip for screw fastening. The “NS” designation for HSN3 roof deck indicates deck provided with nested sidelap. Deep and Shallow VERCOR deck are provided with a nested sidelap.

Parallel Collectors

Spacing of the attachments at diaphragm chords, struts, ties or other collector elements that are parallel to the deck flutes is based on the actual shear to be transferred and shear capacity of the connections used. The spacing of the connections at these shear transfer elements parallel to the deck flutes should not be larger than that for the interior sidelap connections in order to maintain diaphragm rigidity. The maximum spacing of attachments at parallel collectors is 3 ft.

Allowable shear loads for Arc Spot Welds, Arc Seam Welds, Hilti Fasteners, Pneutek Fasteners, and SDI Recognized Screws are listed in Table 4. Allowable shear loads for #12 screws that do not meet the requirements of SDI Recognized Screws are listed in Table 5.

Fillet Welds: Spacing of fillet welds used at collectors parallel to the deck flutes should be based on the shear to be transferred. Allowable shear strength for fillet welds should be determined in accordance with AISI S100.

Table 4: Allowable Shear Strength (lbs/connection) for Arc Spot Welds, Arc Seam Welds, Hilti Fasteners, Pneutek Fasteners and SDI Recognized Screws for Verco Deck Panel Support Connections

Deck Gage	Profile	BMT (in.)	ARC SPOT WELD	ARC SEAM WELD	HILTI X-EDNK22 or X-HSN 24	HILTI X-ENP-19	PNEUTEK SDK61	PNEUTEK SDK63	PNEUTEK K64	PNEUTEK K66	SDI RECOGNIZED SCREWS
			(lbs)	(lbs)	(lbs)	(lbs)	(lbs)	(lbs)	(lbs)	(lbs)	(lbs)
22	B & N	0.0299	783	1231	603	650	618	691	694	736	561
20	B & N	0.0359	1091	1491	720	775	733	791	886	903	673
18	B & N	0.0478	1850	2017	947	1020	951	967	1204	1253	896
16	B & N	0.0598	2309	2564	1169	1259	1158	1125	1474	1630	1121

Table 5: Allowable Shear Strength (lbs/connection) for #12 Screws of Verco Deck Panel Support Connections

Gage	Profile	BMT (in.)	Support Thickness (in.) and Strength, F_y / F_u (ksi)											
			33 mil (0.0346 in.)		43 mil (0.0451 in.)		54 mil (0.0566 in.)		68 mil (0.0713 in.)		97 mil (0.1017 in.)		1/8 in.	$\geq 3/16$ in.
			33/45	50/65	33/45	50/65	33/45	50/65	33/45	50/65	33/45	50/65	36/58	36/58
26	SV	0.0179	247	259	259	259	259	259	259	259	259	259	259	259
	DV	0.0195	255	282	282	282	282	282	282	282	282	282	282	282
24	SV	0.0239	262	332	342	346	346	346	346	346	346	346	346	346
	DV	0.0254	259	336	352	367	367	367	367	367	367	367	367	367
22	SV	0.0299	240	338	369	432	432	432	432	432	432	432	432	432
	B & N	0.0299	240	338	369	432	432	432	432	432	432	432	432	432
20	DV	0.0314	235	335	371	454	454	454	454	454	454	454	454	454
	B & N	0.0359	226	327	360	492	491	519	519	519	519	519	519	519
18	DV	0.0374	226	327	355	494	496	541	541	541	541	541	541	541
	B & N	0.0478	226	327	337	486	488	684	676	691	691	691	691	691
16	B & N	0.0598	226	327	337	486	473	683	679	865	865	865	865	865

Notes for Tables 4 and 5:

- The profile designations used in this table apply to the profile families as summarized below:
 "SV" - Shallow VERCOR
 "DV" - Deep VERCOR
 "B" - PLB & HSB roof deck (including web perforated acoustical deck)
 "N" - PLN3, HSN3, HSN3-NS, PLN24 & N24 roof deck (including web perforated acoustical deck)
- Base metal thickness (BMT) = specified minimum uncoated base metal thickness used in design. Deck subject to thickness tolerances as described in Section A2.4 of AISI S100.
- The minimum arc spot weld effective fusion diameter, d_e , is 1/2 inch. The values for arc spot welds may be applied to arc seam weld with minimum effective fusion width, d_e , of 3/8 inch and minimum length is 1 inch excluding circular ends.
- Details, workmanship, technique and qualification of welds must comply with AWS D1.3.
- The Hilti fasteners are applicable to the following substrate thicknesses:
 X-EDNK22: 1/8 in. \leq substrate thickness \leq 1/4 in.
 X-HSN 24: 1/8 in. \leq substrate thickness \leq 3/8 in.
 X-ENP-19: substrate thickness \geq 1/4 in.
- The Pneutek fasteners are applicable to the following substrate thicknesses:
 SDK61 series: 0.113 in. \leq substrate thickness \leq 0.155 in. K64 series: 0.187 in. \leq substrate thickness \leq 0.312 in.
 SDK63 series: 0.155 in. \leq substrate thickness \leq 0.250 in. K66 series: substrate thickness \geq 0.281 in.
- SDI recognized #12 or #14 screws to supports are limited to Buildex, Elco, Hilti, or Simpson Strong-Tie screws with a minimum substrate thickness of 0.0385 in.
- The #12 screws are self-drilling self-tapping screws with a minimum washer diameter of 5/16-in. and a minimum washer thickness of 0.05 in. The screws must be compliant with ASTM C1513.
- The allowable shear strength of the individual screws, as published by their manufacturer, must meet or exceed the allowable screw connection tensile strengths listed above.
- The strength is the ASD allowable connection shear strength, where Ω is 3.0 for welds and 2.5 for Screws, Hilti and Pneutek fasteners. Convert ASD shear strengths to LRFD based on $\phi = 0.55$ for welds and $\phi = 0.65$ for Screws, Hilti or Pneutek fasteners.
- Allowable values may not be increased one-third for earthquake loading.

VERCO ROOF DECK FINISHES

Verco roof decks are offered in various finishes:

Galvanized

Cold rolled zinc coated steel (ASTM A 653 or A 1063) with coating designation G60 is the standard zinc coated material of the deck industry. Coating designation G90 is a heavier, more costly, zinc coating often specified for exposed exterior applications or other project specific requirements. Other ASTM A 653 galvanized coatings may be available on special request – contact your Verco representative regarding availability.

Cold Rolled with Primer

Acrylic primer is applied to cold rolled steel (ASTM A 1008 or A 1039). The Verco acrylic primer is applied by a roller coat process and oven cured. Verco gray primer is approved by UL for use in direct applied fire-rated assemblies. Refer to page 158 for specific listings.

Due to varying job site conditions, application methods, coating manufacturers, environmental conditions and expectations, it is essential to conduct a field test to determine compatibility of the field applied top coat with the primer coat prior to full scale painting. Verco is not responsible for topcoat compatibility. Primer specifications are available from the Verco website (www.vercodeck.com).

Primer paint is intended to protect steel deck for a short period of exposure in ordinary atmospheric conditions. It should be considered as an impermanent and provisional coating.

Minor aesthetic irregularities and/or imperfections may appear in the paint coating as a result of the manufacturing process.

Galvanized with Primer

Galvanized roof deck is available with factory gray or white primer applied to the underside of the deck exposed to view. Primed galvanized deck is suitable for applications where the deck will be field-painted (may eliminate the need for field priming) or to meet other specific requirements.

Optionally, the primer paint may be left exposed in certain interior applications. Custom color primers are available. Contact your Verco representative regarding availability.

Exposed Product Appearance

Roof deck and cellular deck are structural products. Minor dents and scratches which do not affect the structural capacity of deck are not grounds for rejection. Note that lighter gage material is more susceptible to the appearance of oil canning and minor dents during the shipping, handling and installation process. For cellular deck, flat bottom pans are susceptible to the appearance of oil-canning, particularly when perforated. The appearance of oil canning does not affect the structural integrity of fluted and cellular roof decks and is not grounds for rejection.

ROOF DECK PRODUCT SELECTION

Spans

Span length is one of the key factors in determining an appropriate roof deck profile. Determine logical span lengths (three span is suggested whenever possible) based on the bay size. Contact your Verco representative regarding the availability of deck lengths greater than 40 ft. Consider handling the weight of the deck during installation when evaluating long deck lengths, especially in heavier gages and cellular decks. Also see the Roof Deck Design Example on page 17.

Roofing

Verco roof and cellular deck is a structural product resisting horizontal and vertical loads. Normally, insulation and roofing materials are applied over Verco roof deck to create a water tight roofing system. However, Verco deck can be used for walkways, canopies, sunshades, or other structures which do not require a watertight roof. Attachments for outside weather exposed applications should comply with building code requirements.

Vent Tabs

Verco roof deck is available with factory punched vent tabs to provide positive venting (see Figure 11). Determine venting requirements based on the specific materials installed over the deck. Some leakage during lightweight insulating concrete placement should be anticipated with vented deck. Vent tabs projecting upwards are staggered in interior low flutes at approximately 6 in. on center:

- 5 rows in PLB-36 and HSB-36.
- 3 rows in PLN3 and N3.
- 2 rows in PLN-24 and N-24.



FIGURE 11

ROOF DECK DESIGN EXAMPLE

This design example illustrates the basic issues involved in the design and selection of Vercor roof deck. Various choices are outlined for each point to be considered. *This example illustrates the issues, not all of the possible options.* If you have additional questions, please contact the Vercor Engineering Department.

Design Goals

The design goals for this example are as follows:

- Resist specified uniform vertical loads
- Resist specified horizontal diaphragm loads
- Select an economical roof deck system

Given: 48'-0" x 30'-0" bay size
Deck oriented parallel to 48 ft dimension
Perimeter walls provide lateral restraint
Fire rating not required
Loads:
Dead Load 30 psf
Live Load 50 psf
Total Vertical Load 80 psf
Maximum diaphragm shear 750 plf
Average flexibility factor required 30.0

Span Options

Spacing between the beams or joists will suggest the deck profile options. Refer to "Spans" on page 16 for more information. Based on the profile options, determine the minimum gages to meet vertical load requirements, assuming triple span sheets.

1. 12'-0" c-c spans
Choice: 20 gage PLN3 roof deck.
2. 8'-0" c-c spans
Choice: 20 gage PLB-36 roof deck.
3. 6'-0" c-c spans
Choice: 22 gage PLB-36 roof deck.

→ **Selection:** Option 1 is the most expensive deck choice, but minimizes the number of supports. Option 2 optimizes deck gage based on span. Option 3 minimizes the deck cost but requires the most supports.

Diaphragm Attachment Options

Determine the minimum deck gage and minimum attachments necessary to meet the specified requirements for maximum horizontal diaphragm strength (q). Verify that the horizontal deflection of the diaphragm is within acceptable limits. For purposes of this example, the average required F has been defined to allow a comparison of the options presented, all of which meet the average required F .

ROOF DECK DESIGN EXAMPLE (CONTINUED)

Verco's published allowable diaphragm shear strength tables utilize the ASD factors of safety for Earthquake loading from AISI S100, Table D5, excerpt below.

- To convert from Earthquake loading to Wind loading, utilizing ASD, the published allowable diaphragm shear strength may be multiplied by Ω_d (Earthquake), and then divided by Ω_d (Wind):

As an example:

$$\text{Welds: } 3.00/2.35 = 1.27$$

$$\text{Mechanical Fasteners: } 2.5/2.35 = 1.06$$

- To convert from ASD to LRFD for each connection type, the published allowable diaphragm shear values may be multiplied by the applicable conversion factor, $C = \Omega_d \times \Phi_d$

The following examples are for Earthquake loading:

$$\text{For welds: } C_{\text{WELD}} = 3.00 \times 0.55 = 1.65$$

$$\text{For mechanical fasteners: } C_{\text{MECHANICAL FASTENER}} = 2.5 \times 0.65 = 1.625$$

$$\text{For deck panel buckling*}: C_{\text{BUCKLING}} = 2.00 \times 0.80 = 1.60$$

*The shaded areas in the allowable diaphragm shear tables indicate where buckling is the limit state rather than the connections.

Safety Factors and Resistance Factors for Diaphragms

Load Type or Combinations Including	Connection Type ¹	Limit State			
		Connection Related		Panel Buckling ²	
		Ω_d (ASD)	Φ_d (LRFD)	Ω_d (ASD)	Φ_d (LRFD)
Earthquake	Welds	3.00	0.55		
	Screws	2.50	0.65		
Wind	Welds	2.35	0.70	2.00	0.80
	Screws				
All Others	Welds	2.65	0.60		
	Screws	2.50	0.65		

- For mechanical fasteners - such as Power Actuated Fasteners or Forced Entry Fasteners, the factors of safety for screws may be used.
- Panel buckling is considered out-of-plane deck buckling and not local buckling at fasteners.

ROOF DECK DESIGN EXAMPLE (CONTINUED)

In general, using a lighter gage deck with more attachments is more economical than using a heavier deck with fewer attachments. When selecting the attachment system, consider the use of mechanical fasteners (power-actuated fasteners or screws) in conjunction with the PunchLok II System to minimize both installation and inspection costs. Together these benefits offer an economical deck system which can be installed in a minimum amount of time.

1. 12'-0" c-c spans

Attachment Choices:

Deck	Supports		Sidelaps		q, Earthquake (plf)		F
	Type	Pattern	Type	Spacing	ASD	LRFD	
3" Deep Roof Deck							
20 ga PLN3	Hilti	32/5	VSC2	18" o.c.	754	1225	10.4 + 13R = 14.8
20 ga PLN3	Pneutek	32/5	VSC2	18" o.c.	794	1290	12.9 + 14R = 17.6
20 ga PLN3	Screw	32/5	VSC2	12" o.c.	891	1448	9.2 + 14R = 14.0
20 ga PLN3	Weld	32/5	VSC2	18" o.c.	752	1241	11.4 + 13R = 15.9

2. 8'-0" c-c spans

Attachment Choices:

Deck	Supports		Sidelaps		q, Earthquake (plf)		F
	Type	Pattern	Type	Spacing	ASD	LRFD	
1½" Deep Roof Deck							
20 ga PLB-36	Hilti	36/5	VSC2	18" o.c.	818	1433	4.8 + 59R = 24.9
20 ga PLB-36	Pneutek	36/5	VSC2	18" o.c.	882	1329	7.2 + 60R = 27.5
20 ga PLB-36	Screw	36/5	VSC2	18" o.c.	760	1235	5.9 + 59R = 26.0
20 ga PLB-36	Weld	36/5	VSC2	18" o.c.	887	1464	5.7 + 59R = 25.8

3. 6'-0" c-c spans

Attachment Choices:

Deck	Supports		Sidelaps		q, Earthquake (plf)		F
	Type	Pattern	Type	Spacing	ASD	LRFD	
1½" Deep Roof Deck							
22 ga PLB-36	Hilti	36/7/4	VSC2	12" o.c.	849	1379	8.0 + 18R = 14.1
22 ga PLB-36	Pneutek	36/7/4	VSC2	12" o.c.	895	1454	10.7 + 19R = 17.0
22 ga PLB-36	Screw	36/7/4	VSC2	12" o.c.	794	1290	9.2 + 18R = 15.3
22 ga PLB-36	Weld	36/7/4	VSC2	12" o.c.	846	1396	8.9 + 18R = 15.0

Notes:

- F is based on R = ⅓ for 3 span sheets.
- Diaphragm shear and flexibility values listed for all mechanical fasteners assume minimum ¼ in. thick steel supports.

ROOF DECK DESIGN EXAMPLE (CONTINUED)

- Values shown are those necessary to meet the maximum shear (q) and average Flexibility Factor (F) specified. Maximum economy can be achieved by zoning the diaphragm, reducing deck gage and/or attachments as shear requirements diminish across the building.
- Attachment of deck to parallel shear collectors is required but not shown.

Finish Options

The total installed cost, including field painting, should be used to determine the deck finish choice. Choices include:

1. Cold rolled with primer.
2. Galvanized.
3. Galvanized with primer painted underside.

Fire Ratings

Hourly fire ratings, if required, may affect the maximum allowable deck span and/or minimum deck gage. Refer to the UL Fire Resistance Directory or Verco's Evaluation Report for further information. Note that only Verco cold rolled with Verco factory gray primer and Verco galvanized finishes are approved for use with spray applied fire proofing.

Legacy
2015 IBC

ROOF DECK ACCESSORIES

Profile Closures

Profile closures made from steel or neoprene are designed to fit Verco's deck products. See Table 6 for availability of closures by deck profile. Steel closures are 22 gage with a 1 in. return lip for fastening to deck with screws or tack welds. Neoprene closures for PLB-36, HSB-36, PLN3, HSN3, PLN-24, and N-24 decks are 1 in. thick individual plugs. See Figure 12 for typical installation of closures.

Table 6: Availability of Profile Closures

Deck Profile	Steel Closures		Neoprene Closures	
	Underside	Topside	Underside	Topside
PLB-36 or HSB-36	✓	✓	✓	✓
PLN3 or HSN3	✓		✓	✓
PLN-24 or N-24	✓		✓	✓

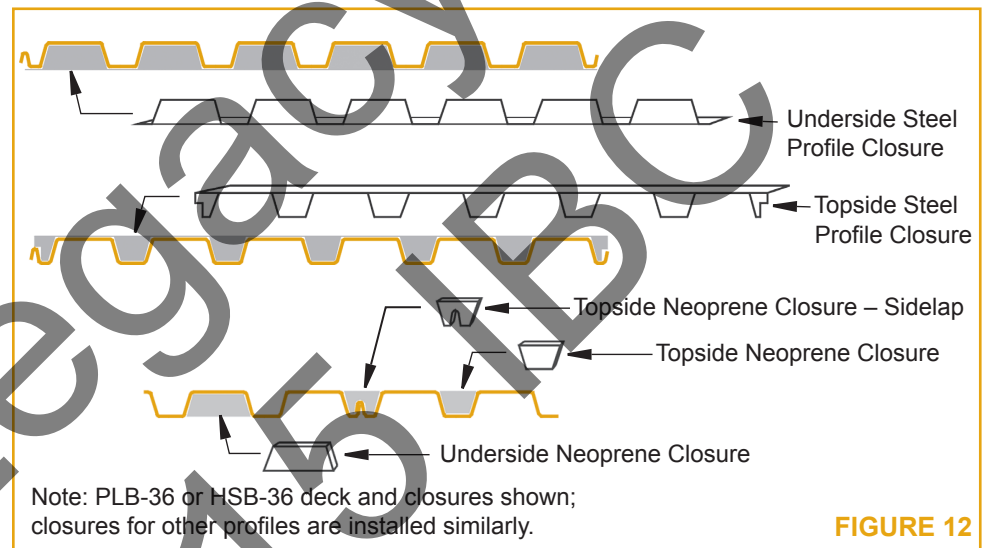

FIGURE 12

Neoprene profile closures are available for both Deep and Shallow VERCOR decks. These closures are 1 in. thick, 36 in. long strips and are designed to fit into either the underside or topside of the profile. See Figure 13.

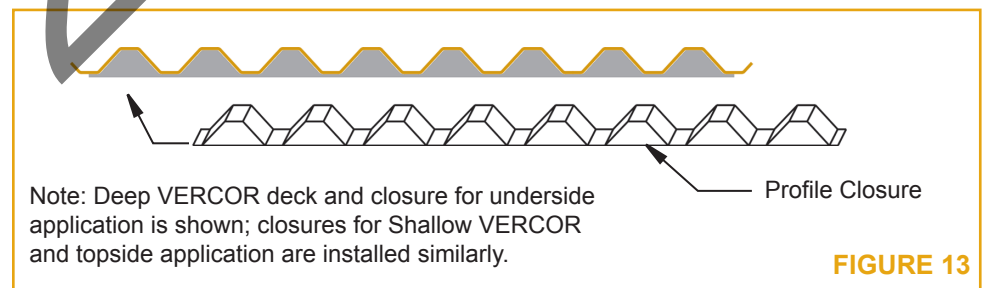
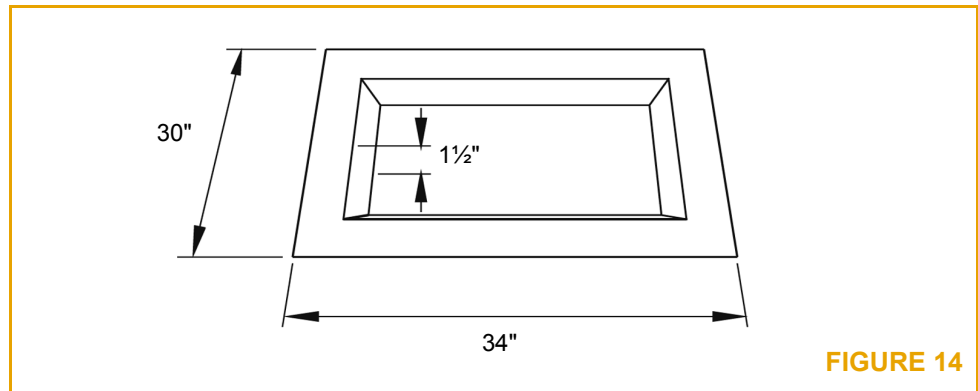

FIGURE 13

Sump Pan

- 14 gage
- Flat recessed



SPECIFICATION SECTION 05 31 23 - STEEL ROOF DECKING

Specifications utilizing VERCOR roof deck formatted in accordance with MasterFormat 2012, Construction Specifications Institute (CSI) and Construction Specifications Canada (CSC) are available for download from Vercor's website (www.vercodeck.com).

Legion 2015 IBC

USING THE TABLES

These illustrations highlight important considerations for using the deck tables. The values in the tables were determined in standard US units.

Type PLB™ -36 or HSB® -36

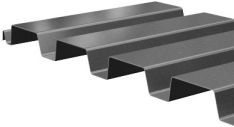

Uniform load which produces maximum allowable stress in deck

Allowable Uniform Loads (psf)

DECK SPAN	GAGE	CRITERIA	SPAN (ft-in.)									
			2'-0"	3'-0"	4'-0"	5'-0"	5'-6"	6'-0"	6'-6"	7'-0"	7'-6"	8'-0"
SINGLE	22	Stress	300	300	220	141	116	98	83	72	63	55
		L/360	◆◆◆	287	121	62	47	36	28	23	18	15
		L/240	◆◆◆	◆◆◆	182	93	70	54	42	34	28	23
SINGLE	20	Stress	300	300	288	184	152	128	109	94	82	72
		L/360	◆◆◆	◆◆◆	150	77	58	44	35	28	23	19
		L/240	◆◆◆	◆◆◆	225	115	86	67	52	42	34	27

Uniform load which produces L/240 deflection in deck

How to use the uniform load tables:

1. Using the total load, select the gage and the span with equal or greater value for stress.
2. Using the appropriate load combinations, select the gage and the span with equal or greater value for a selected deflection.
3. Select the gage and the span for the roof deck that meets the criteria of both steps 1 and 2.

Type PLB™ -36

- 36/7 Weld Pattern at Supports
- Sidelaps Connected with PunchLok II Tool



Allowable Diaphragm Shear Strength, q (plf) and Flexibility Factors, F ((in./lb)x10⁶)

GAGE	SIDELAP ATTACHMENT	SPAN (ft-in.)							
		4'-0"	5'-0"	6'-0"	7'-0"	8'-0"	9'-0"	10'-0"	
22	VSC2 @ 24"	q	700	693	581	594	516	535	482
		F	8+28R	8.9+22R	10.4+18R	10.8+15R	12+12R	12.2+11R	13.3+9R
	VSC2 @ 18"	q	842	808	688	615	682	613	618
		F	7.2+29R	8.1+23R	9.5+18R	10+13R	10.3+13R	11.3+11R	11.5+10R
	VSC2 @ 12"	q	971	914	875	847	825	800	704
		F	6.6+29R	7.6+23R	8.2+19R	8.8+16R			

Sidelap Attachment Type and Spacing
(VSC2 = Verco Sidelap Connection made with PunchLok II Tool)

Diaphragm Shear Capacity (q) and Flexibility Factors (F) based on sidelaps attached with VSC2s at 24" oc and 36/7 weld pattern at supports

(Examples above were taken from the tables on pages 29 and 33.)

Notes:



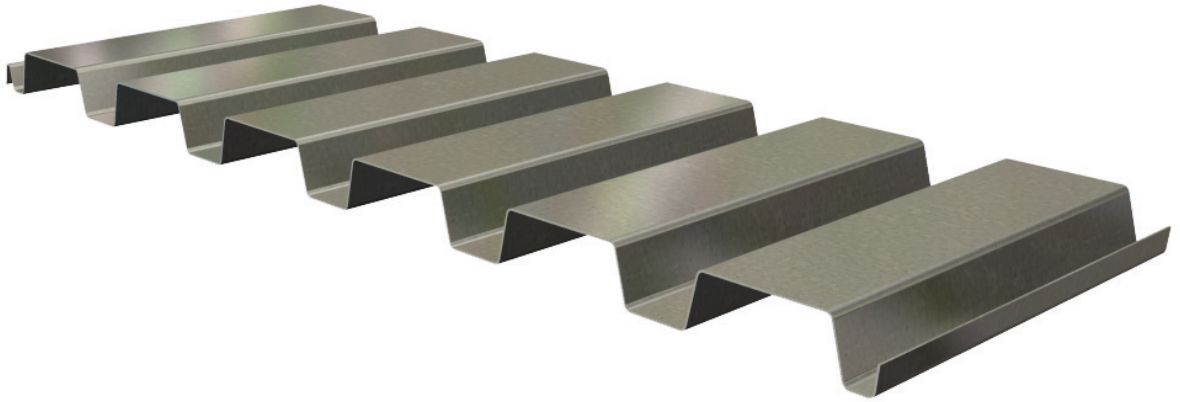

PLB™-36 and HSB®-36

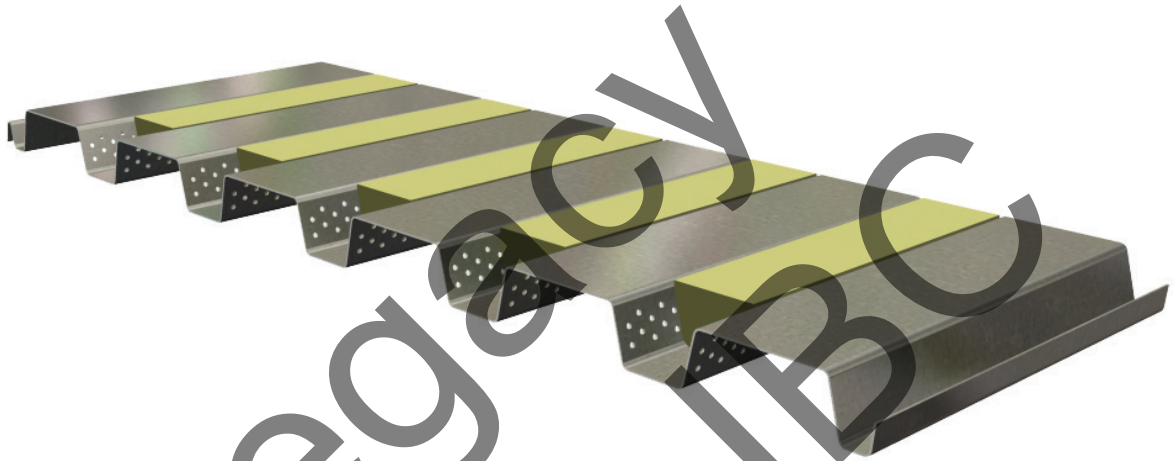

PLB™-36 AC and HSB®-36 AC

PLB™ AND HSB® DECK CONTENTS

Section Properties	26
Vertical Load Capacity	29
PLB™-36 Allowable Diaphragm Shear Strength and Flexibility Tables	30-64
PLB-36 with Welds	30-33
PLB-36 with Hilti fasteners	34-44
PLB-36 with Pneutek fasteners	45-60
PLB-36 with Screws	61-64
ShearTranz® II-42 with PLB™-36 Deck	65-66
HSB®-36 Allowable Diaphragm Shear Strength and Flexibility Tables	67-78
HSB-36 with Welds	67-70
HSB-36-SS with Screws	71-74
HSB-36-SS with Welds	75-78
Acoustical Properties	155

Type PLB™ -36 or HSB® -36

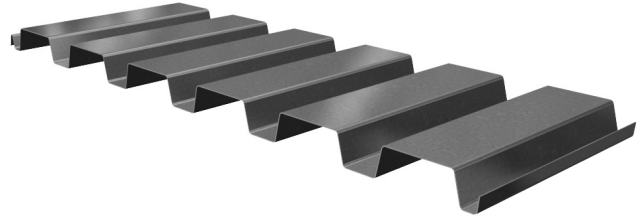

- 1½" Deep Roof Deck
- Primer Painted or Galvanized
- PLB-36 Deck used with PunchLok II System
- HSB-36 Deck used with TSWs, BPs or Screws

Dimensions

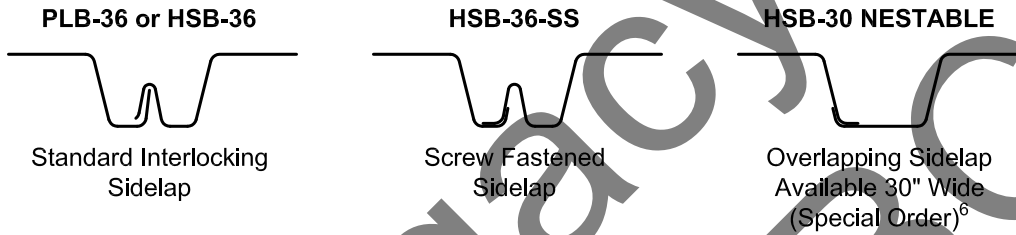
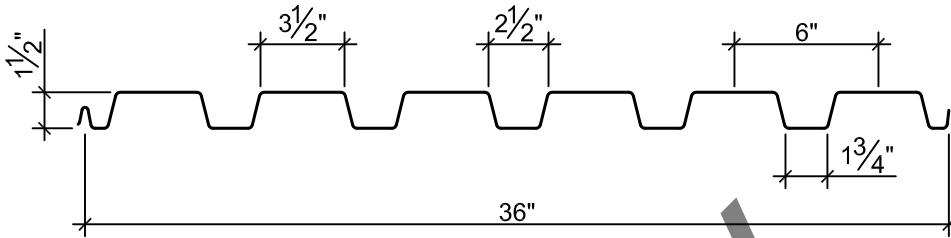

Deck Weight and Section Properties

Gage	Weight		I_d for Deflection		Moment		Allowable Reactions per ft of Width (lb) due to Web Crippling									
	Galv (psf)	Painted (psf)	Single Span (in. ⁴ /ft)	Multi Span (in. ⁴ /ft)	+ S_{eff} (in. ³ /ft)	- S_{eff} (in. ³ /ft)	One Flange Loading				Two Flange Loading					
							End Bearing Length			Interior Bearing Length		End Bearing Length			Interior Bearing Length	
							2"	3"	4"	3"	4"	2"	3"	4"	3"	4"
22	1.9	1.8	0.177	0.192	0.176	0.188	935	1076	1163	1559	1671	962	1078	1150	1935	2084
20	2.3	2.2	0.219	0.231	0.230	0.237	1301	1492	1609	2190	2340	1413	1576	1675	2744	2947
18	2.9	2.8	0.302	0.306	0.314	0.331	2181	2484	2667	3714	3950	2551	2823	2987	4713	5038
16	3.5	3.4	0.381	0.381	0.399	0.410	3265	3699	3955	5607	5938	4018	4422	4660	7168	7631

- Notes:**
1. Section properties are based on $F_y = 50,000$ psi.
 2. I_d is for deflection due to uniform loads.
 3. S_{eff} (+ or -) is the effective section modulus.
 4. Multiply tabulated deck values listed above by the following adjustment factors to obtain acoustical deck section properties:

Deck Type	I_d for Deflection		Moment		Allowable Reactions per ft of Width (lb)			
	Single Span	Multi Span	+ S_{eff}	- S_{eff}	One Flange Loading		Interior Bearing	
					End Bearing		Interior Bearing	
B - Acoustical	0.98	0.98	0.97	0.97	1.00		0.76	

5. Allowable (ASD) reactions are based on web crippling, per AISI S100 Section C3.4, where $\Omega_w = 1.70$ for end bearing and 1.75 for interior bearing. Nominal reactions may be determined by multiplying the table values by Ω_w . LRFD reactions may be determined by multiplying nominal reactions by $\Phi_w = 0.90$ for end reactions and 0.85 for interior reactions.
6. Diaphragm values for HSB-30 Nestable are outside the scope of Verco's Evaluation Report.

Type PLB™ -36 or HSB® -36

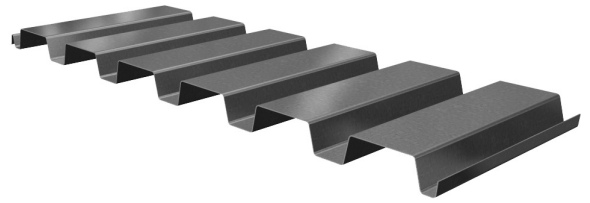

Attachment Patterns to Supports

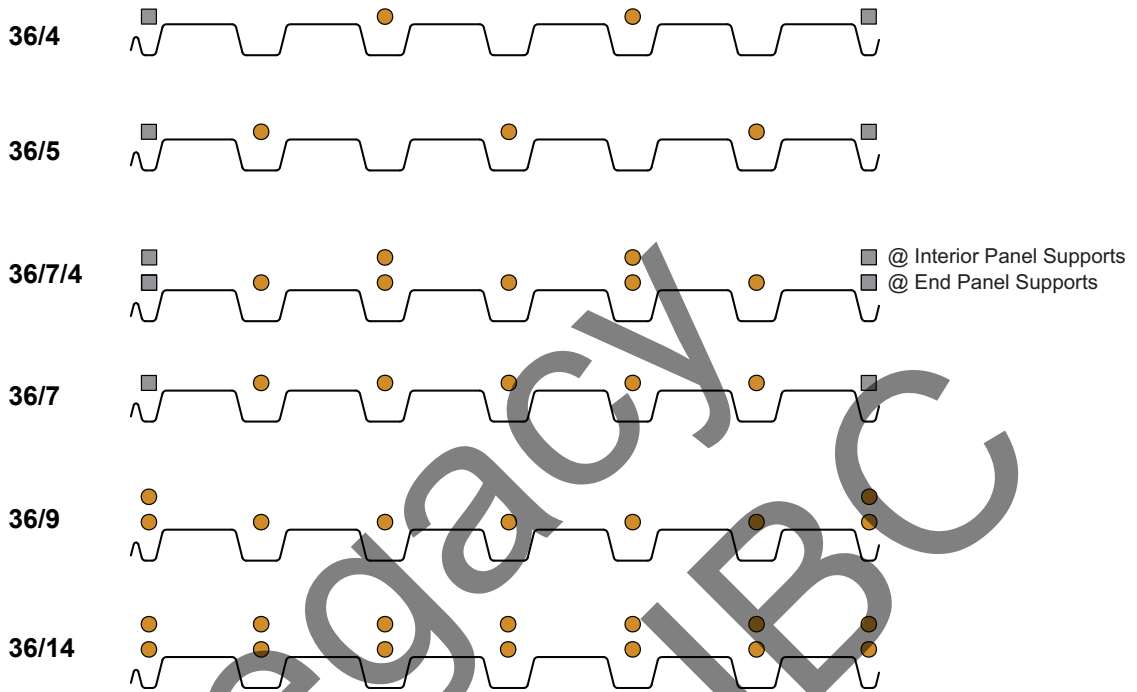

Note: ● indicates location of arc spot weld, power actuated fastener, or screw as indicated in the load tables.
 ■ indicates location of arc seam weld, power actuated fastener, or screw as indicated in the load tables.

36/7/4 Attachment Pattern

The 36/7/4 pattern requires a 36/7 attachment pattern at end panel supports and a 36/4 attachment pattern at interior panel supports.

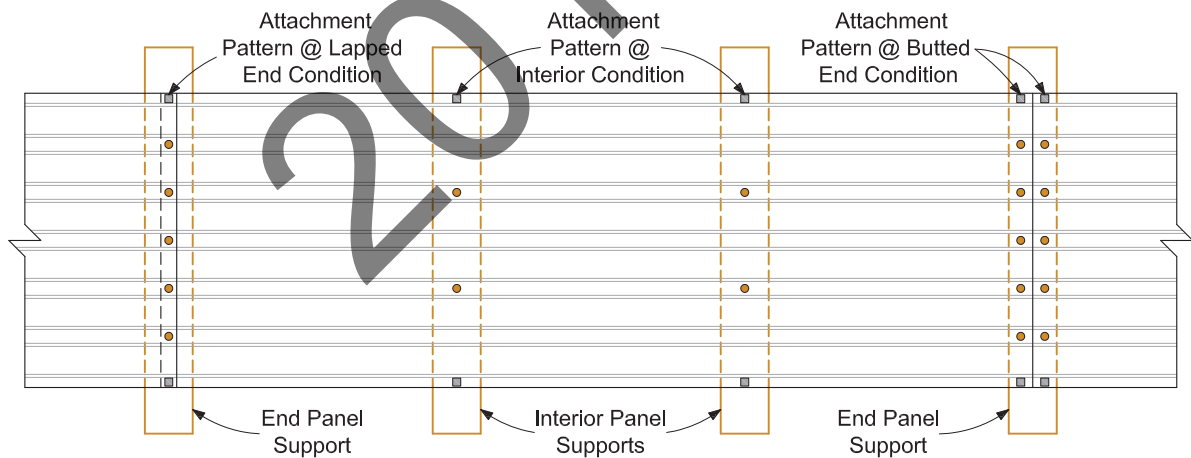

Footnotes for Allowable Uniform Load Tables

1. Stress = Allowable uniform load based on maximum allowable flexural stress in deck.
2. L/360, L/240 or L/180 = Uniform load which produces selected deflection in deck.
3. The symbol ♦♦ indicates allowable uniform load based on deflection exceeds allowable uniform load based on stress.
4. Nominal uniform loads governed by stress may be determined by multiplying the allowable values in the table by $\Omega_b = 1.67$. LRFD loads may be determined by multiplying nominal loads by $\Phi_b = 0.95$.

Type PLB™ -36 or HSB® -36

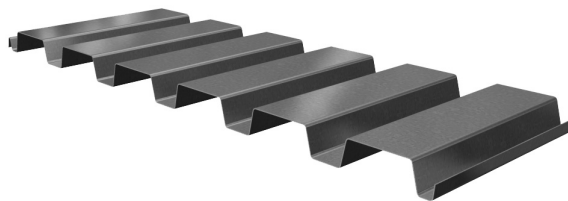

Footnotes for Diaphragm Shear Strength and Flexibility Factor Tables

General Notes

- VSC2 = Vercos Sidelap Connection 2; BP = Button Punch; TSW = Top Seam Weld; #10 = #10 Generic Screw. Sidelap connections are not required at support locations.
- The dimension from the first and last sidelap connection within each span is to be no more than one-half of specified spacing.
- R is the ratio of vertical span (L_V) of the deck to the length (L_S) of the deck sheet: $R = L_V / L_S$.
- Interpolation of diaphragm shear strength between adjacent spans or sidelap spacings is permissible. For interpolation of the diaphragm flexibility factor between adjacent spans, use the flexibility factor for the closest adjacent span length.
- Diaphragm shear values for side seam fasteners placed at spacings other than those in the table should be determined based on the number of fasteners in each span.
- For web perforated acoustical deck profiles, modify tabulated q and F values using the following adjustment factors:

Deck Type	R_q	R_F
B - Acoustical	0.97	1.02

Note: Adjustment Factor, R_q must be applied only to allowable diaphragm shear strengths governed by panel buckling which are shown in the shaded areas of the diaphragm tables.

Notes Specific to Tables using Welds to Supports

- The allowable diaphragm shear values in the table utilize a factor of safety, $\Omega = 3.0$ (limited by connections) with the exception of the gray shaded table values, which utilize a factor of safety of $\Omega = 2.0$ (limited by panel buckling).
- A 1" x 3/8" effective arc seam weld is required at supports adjacent to sidelap and 1/2" effective diameter arc spot welds are required at supports in interior flutes.

Notes Specific to Tables using Hilti or Pneutek Fasteners to Supports

- Refer to Hilti's Evaluation Report ESR-2776 for additional fastening patterns utilizing Hilti fasteners with the PunchLok II System.
- X-EDNK22 = Hilti EDNK22 THQ12 fastener; X-ENP-19 = Hilti X-ENP-19 L15 fastener; K66 = Pneutek K66062 or K66075 fasteners; K64 = Pneutek K64062 fastener; SDK63 = Pneutek SDK63075; SDK61 = Pneutek SDK61075
- The allowable diaphragm shear values in the table utilize a factor of safety, $\Omega = 2.5$ (limited by connections) with the exception of the shaded table values, which utilize a factor of safety of $\Omega = 2.0$ (limited by panel buckling).

Notes Specific to Tables using Screws to Supports

- The allowable diaphragm shear values in the table utilize a factor of safety, $\Omega = 2.5$ (limited by connections) with the exception of the shaded table values, which utilize a factor of safety of $\Omega = 2.0$ (limited by panel buckling).
- Deck is attached with minimum #12 Screws (self drilling, self tapping) to supports. Select appropriate screw based on actual substrate thickness. This table is provided as a guide, proper selection should be verified based on the specific fasteners used.

Support Thickness	Fastener Designation
33 mil (0.0346") to 3/16"	#3 Drill Point
1/8" to 1/4"	#4 Drill Point
1/8" to 1/2"	#5 Drill Point

- All tabulated diaphragm values shown in this section are for a minimum 0.0385 in. thick support with SDI recognized screws produced by Buildex, Elco, Hilti or Simpson Strong-Tie. If the minimum support thickness can not be met or a screw that is not recognized by SDI is used, modify tabulated q and F values based on actual substrate and thickness using Adjustment Factors listed in this table.

Deck Gage	Factors	Substrate Thickness and Strength									
		20 ga		18 ga		16 ga		14 ga		≥ 12 ga	
		33 mil (0.0345 in) 33 ksi	50 ksi	43 mil (0.0451 in) 33 ksi	50 ksi	54 mil (0.0566 in) 33 ksi	50 ksi	68 mil (0.0713 in) 33 ksi	50 ksi	≥ 97 mil (0.1017 in) 33 ksi	50 ksi
22	R_q	0.44	0.61	0.67	0.78	0.78	0.78	0.78	0.78	0.78	0.78
	R_F	1.28	1.25	1.17	1.00	1.00	1.00	1.00	1.00	1.00	1.00
20	R_q	0.34	0.49	0.54	0.74	0.74	0.78	0.78	0.78	0.78	0.78
	R_F	1.31	1.31	1.24	1.19	1.15	1.00	1.00	1.00	1.00	1.00
18	R_q	0.26	0.37	0.38	0.55	0.55	0.78	0.76	0.78	0.78	0.78
	R_F	1.34	1.39	1.30	1.31	1.26	1.18	1.19	1.00	1.00	1.00
16	R_q	0.20	0.30	0.30	0.44	0.43	0.65	0.61	0.78	0.78	0.78
	R_F	1.43	1.66	1.39	1.54	1.33	1.34	1.25	1.00	1.00	1.00

- Adjustment factors are based on connection strengths determined in accordance with Section E4 of AISI S100. These self drilling, self tapping screws must be compliant with ASTM C1315.
- Allowable Diaphragm Strength = $q \cdot R_q$; Flexibility Factor = $F \cdot R_F$.
- These adjustment factors are based on the maximum adjustment for the tabulated span lengths and fastener patterns. To calculate a specific condition, use design equations listed at the end of Evaluation Report ER-0217.

Type PLB™ -36 or HSB® -36

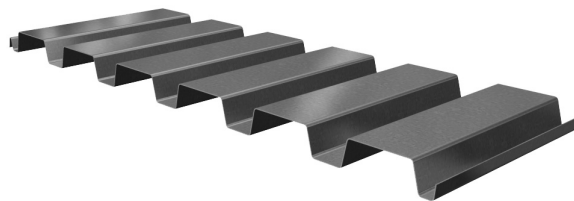

Allowable Uniform Loads (psf)

DECK			SPAN (ft.-in.)																						
SPAN	GAGE	CRITERIA	2'-0"	3'-0"	4'-0"	5'-0"	5'-6"	6'-0"	6'-6"	7'-0"	7'-6"	8'-0"	8'-6"	9'-0"	9'-6"	10'-0"	11'-0"	12'-0"							
SINGLE	22	Stress	300	300	220	141	116	98	83	72	63	55	49	43	39	35	29	24							
		L/360	◆◆◆	287	121	62	47	36	28	23	18	15	13	11	9	8	6	4							
		L/240	◆◆◆	◆◆◆	182	93	70	54	42	34	28	23	19	16	14	12	9	7							
	20	L/180	◆◆◆	◆◆◆	◆◆◆	124	93	72	56	45	37	30	25	21	18	15	12	9							
		Stress	300	300	288	184	152	128	109	94	82	72	64	57	51	46	38	32							
		L/360	◆◆◆	◆◆◆	150	77	58	44	35	28	23	19	16	13	11	10	7	6							
	18	L/240	◆◆◆	◆◆◆	225	115	86	67	52	42	34	28	23	20	17	14	11	8							
		L/180	◆◆◆	◆◆◆	◆◆◆	153	115	89	70	56	45	37	31	26	22	19	14	11							
		Stress	300	300	300	251	208	174	149	128	112	98	87	78	70	63	52	44							
	16	L/360	◆◆◆	◆◆◆	◆◆◆	159	119	92	72	58	47	39	32	27	23	20	15	11							
		L/240	◆◆◆	◆◆◆	◆◆◆	212	159	122	96	77	63	52	43	36	31	26	20	15							
		L/180	◆◆◆	◆◆◆	◆◆◆	267	200	154	121	97	79	65	54	46	39	33	25	19							
DOUBLE	22	Stress	300	300	300	300	264	222	189	163	142	125	110	99	88	80	66	55							
		L/360	◆◆◆	◆◆◆	261	133	100	77	61	49	40	33	27	23	19	17	13	10							
		L/240	◆◆◆	◆◆◆	◆◆◆	200	150	116	91	73	59	49	41	34	29	25	19	14							
	20	L/180	◆◆◆	◆◆◆	◆◆◆	267	200	154	121	97	79	65	54	46	39	33	25	19							
		Stress	300	300	235	150	124	104	89	77	67	59	52	46	42	38	31	26							
		L/360	◆◆◆	◆◆◆	◆◆◆	◆◆◆	122	94	74	59	48	40	33	28	24	20	15	12							
	18	L/240	◆◆◆	◆◆◆	◆◆◆	◆◆◆	◆◆◆	◆◆◆	◆◆◆	◆◆◆	◆◆◆	◆◆◆	◆◆◆	49	42	35	30	23	18						
		L/180	◆◆◆	◆◆◆	◆◆◆	◆◆◆	◆◆◆	◆◆◆	◆◆◆	◆◆◆	◆◆◆	◆◆◆	◆◆◆	◆◆◆	◆◆◆	◆◆◆	◆◆◆	◆◆◆	30	23					
		Stress	300	300	296	190	157	132	112	97	84	74	66	59	53	47	39	33							
	16	L/360	◆◆◆	◆◆◆	◆◆◆	◆◆◆	146	113	89	71	58	48	40	33	28	24	18	14							
		L/240	◆◆◆	◆◆◆	◆◆◆	◆◆◆	◆◆◆	◆◆◆	◆◆◆	◆◆◆	◆◆◆	◆◆◆	◆◆◆	◆◆◆	◆◆◆	◆◆◆	◆◆◆	◆◆◆	37	28					
		L/180	◆◆◆	◆◆◆	◆◆◆	◆◆◆	◆◆◆	◆◆◆	◆◆◆	◆◆◆	◆◆◆	◆◆◆	◆◆◆	◆◆◆	◆◆◆	◆◆◆	◆◆◆	◆◆◆	◆◆◆	37	28				
TRIPLE	22	Stress	300	300	300	265	219	184	157	135	118	103	92	82	73	66	55	46							
		L/360	◆◆◆	◆◆◆	◆◆◆	258	194	149	117	94	76	63	53	44	38	32	24	19							
		L/240	◆◆◆	◆◆◆	◆◆◆	◆◆◆	◆◆◆	◆◆◆	◆◆◆	◆◆◆	◆◆◆	◆◆◆	◆◆◆	◆◆◆	◆◆◆	◆◆◆	◆◆◆	◆◆◆	◆◆◆	64	48	37			
	18	L/180	◆◆◆	◆◆◆	◆◆◆	◆◆◆	◆◆◆	◆◆◆	◆◆◆	◆◆◆	◆◆◆	◆◆◆	◆◆◆	◆◆◆	◆◆◆	◆◆◆	◆◆◆	◆◆◆	◆◆◆	◆◆◆	◆◆◆	64	48	37	
		Stress	300	300	300	300	271	228	194	167	146	128	113	101	91	82	68	57							
		L/360	◆◆◆	◆◆◆	◆◆◆	◆◆◆	241	186	146	117	95	78	65	55	47	40	30	23							
	16	L/240	◆◆◆	◆◆◆	◆◆◆	◆◆◆	◆◆◆	◆◆◆	◆◆◆	◆◆◆	◆◆◆	◆◆◆	◆◆◆	◆◆◆	◆◆◆	◆◆◆	◆◆◆	◆◆◆	◆◆◆	◆◆◆	◆◆◆	◆◆◆	◆◆◆	◆◆◆	◆◆◆
		L/180	◆◆◆	◆◆◆	◆◆◆	◆◆◆	◆◆◆	◆◆◆	◆◆◆	◆◆◆	◆◆◆	◆◆◆	◆◆◆	◆◆◆	◆◆◆	◆◆◆	◆◆◆	◆◆◆	◆◆◆	◆◆◆	◆◆◆	◆◆◆	◆◆◆	◆◆◆	◆◆◆
		Stress	300	300	294	188	155	131	111	96	84	73	65	58	52	47	39	33							
	TRIPLE	22	L/360	◆◆◆	◆◆◆	247	127	95	73	58	46	38	31	26	22	18	16	12	9						
			L/240	◆◆◆	◆◆◆	◆◆◆	◆◆◆	143	110	86	69	56	46	39	33	28	24	18	14						
			L/180	◆◆◆	◆◆◆	◆◆◆	◆◆◆	◆◆◆	◆◆◆	◆◆◆	◆◆◆	◆◆◆	◆◆◆	◆◆◆	◆◆◆	◆◆◆	◆◆◆	◆◆◆	◆◆◆	◆◆◆	◆◆◆	◆◆◆	◆◆◆	◆◆◆	
20		Stress	300	300	300	237	196	165	140	121	105	93	82	73	66	59	49	41							
		L/360	◆◆◆	◆◆◆	298	152	115	88	69	56	45	37	31	26	22	19	14	11							
		L/240	◆◆◆	◆◆◆	◆◆◆	229	172	132	104	83	68	56	47	39	33	29	21	17							
18		L/180	◆◆◆	◆◆◆	◆◆◆	◆◆◆	◆◆◆	◆◆◆	◆◆◆	◆◆◆	◆◆◆	◆◆◆	◆◆◆	◆◆◆	◆◆◆	◆◆◆	◆◆◆	◆◆◆	◆◆◆						
		Stress	300	300	300	300	274	230	196	169	147	129	115	102	92	83	68	57							
		L/360	◆◆◆	◆◆◆	◆◆◆	202	152	117	92	74	60	49	41	35	29	25	19	15							
16		L/240	◆◆◆	◆◆◆	◆◆◆	◆◆◆	228	175	138	110	90	74	62	52	44	38	28	22							
		L/180	◆◆◆	◆◆◆	◆◆◆	◆◆◆	◆◆◆	◆◆◆	◆◆◆	◆◆◆	◆◆◆	◆◆◆	◆◆◆	◆◆◆	◆◆◆	◆◆◆	◆◆◆	◆◆◆	◆◆◆						
		Stress	300	300	300	300	300	285	243	209	182	160	142	127	114	103	85	71							
16	L/360	◆◆◆	◆◆◆	◆◆◆	251	189	145	114	92	74	61	51	43	37	31	24	18								
	L/240	◆◆◆	◆◆◆	◆◆◆	◆◆◆	283	218	172	137	112	92	77	65	55	47	35	27								
	L/180	◆◆◆	◆◆◆	◆◆◆	◆◆◆	◆◆◆	◆◆◆	◆◆◆	◆◆◆	◆◆◆	◆◆◆	◆◆◆	◆◆◆	◆◆◆	◆◆◆	◆◆◆	◆◆◆	◆◆◆	◆◆◆	◆◆◆					

See footnotes on page 27.

Type PLB™ -36

- 36/4 Weld Pattern at Supports
- Sidelaps Connected with PunchLok II Tool



Allowable Diaphragm Shear Strength, q (plf) and Flexibility Factors, F ((in./lb)x10⁶)

DECK GAGE	SIDELAP ATTACHMENT	SPAN (ft.-in.)									
		4'-0"	5'-0"	6'-0"	7'-0"	8'-0"	9'-0"	10'-0"	11'-0"	12'-0"	
22	VSC2 @ 24"	q	567	578	496	515	458	478	435		
		F	-5.1+269R	-1.4+215R	2.4+178R	4+153R	6.5+133R	7.3+118R	9.2+106R		
	VSC2 @ 18"	q	688	675	585	590	594	539	548		
		F	-6.3+270R	-2.5+216R	1.1+179R	2.8+153R	4.1+134R	6.1+119R	6.9+107R		
	VSC2 @ 12"	q	789	759	738	723	711	701	694		
		F	-7.2+270R	-3.4+216R	-0.7+180R	1.2+154R	2.6+135R	3.7+119R	4.7+107R		
	VSC2 @ 8"	q	943	949	908	918	889	899	878		
		F	-8.4+271R	-5+217R	-2.3+180R	-0.7+155R	0.8+135R	1.7+120R	2.6+108R		
	VSC2 @ 6"	q	1048	1034	1024	1017	1011	1007	1001		
		F	-9.2+271R	-5.6+217R	-3.3+181R	-1.6+155R	-0.3+135R	0.7+120R	1.5+108R		
	VSC2 @ 4"	q	1169	1162	1157	1154	1151	1149	1001		
		F	-10.1+271R	-6.6+217R	-4.4+181R	-2.7+155R	-1.5+136R	-0.5+121R	0.3+108R		
20	VSC2 @ 24"	q	777	792	682	708	632	658	601	625	579
		F	-1+170R	1.3+136R	3.9+113R	4.8+96R	6.6+84R	7+75R	8.3+67R	8.4+61R	9.5+55R
	VSC2 @ 18"	q	936	919	801	808	813	741	752	761	709
		F	-2.1+171R	0.3+136R	2.7+113R	3.8+97R	4.6+85R	6+75R	6.4+67R	6.7+61R	7.7+56R
	VSC2 @ 12"	q	1066	1028	1001	981	966	953	943	935	912
		F	-2.9+171R	-0.5+137R	1.2+114R	2.4+97R	3.3+85R	4+76R	4.6+68R	5.1+62R	5.5+57R
	VSC2 @ 8"	q	1259	1265	1216	1227	1192	1205	1178	1085	912
		F	-3.9+171R	-1.8+137R	-0.1+114R	0.9+98R	1.9+86R	2.4+76R	3+68R	3.4+62R	3.8+57R
	VSC2 @ 6"	q	1385	1368	1357	1348	1341	1336	1313	1085	912
		F	-4.6+172R	-2.3+137R	-0.8+114R	0.2+98R	1+86R	1.7+76R	2.2+69R	2.6+62R	2.9+57R
	VSC2 @ 4"	q	1527	1519	1513	1509	1506	1504	1313	1085	912
		F	-5.3+172R	-3.1+137R	-1.7+115R	-0.6+98R	0.2+86R	0.8+76R	1.2+69R	1.6+62R	2+57R
18	VSC2 @ 24"	q	1238	1253	1084	1118	1000	1038	949	985	914
		F	1.4+83R	2.3+66R	3.8+55R	4+47R	5+41R	5.1+37R	5.8+33R	5.7+30R	6.3+27R
	VSC2 @ 18"	q	1471	1441	1262	1269	1274	1163	1178	1190	1110
		F	0.5+83R	1.6+67R	2.9+55R	3.3+47R	3.7+42R	4.4+37R	4.5+33R	4.6+30R	5.2+28R
	VSC2 @ 12"	q	1661	1600	1557	1525	1501	1481	1465	1452	1394
		F	-0.1+84R	1.1+67R	1.9+56R	2.4+48R	2.9+42R	3.2+37R	3.5+33R	3.7+30R	3.9+28R
	VSC2 @ 8"	q	1936	1942	1869	1884	1833	1849	1809	1659	1394
		F	-0.8+84R	0.2+67R	1.1+56R	1.5+48R	2+42R	2.2+37R	2.6+33R	2.7+30R	2.9+28R
	VSC2 @ 6"	q	2114	2088	2070	2057	2047	2038	2007	1659	1394
		F	-1.2+84R	-0.1+67R	0.6+56R	1.1+48R	1.5+42R	1.8+37R	2.1+34R	2.3+31R	2.4+28R
	VSC2 @ 4"	q	2311	2299	2291	2285	2280	2276	2007	1659	1394
		F	-1.6+84R	-0.5+67R	0.2+56R	0.7+48R	1+42R	1.3+37R	1.6+34R	1.8+31R	1.9+28R
16	VSC2 @ 24"	q	1606	1635	1418	1469	1317	1370	1254	1304	1211
		F	2.6+47R	3+38R	4.1+31R	4.1+27R	4.9+23R	4.8+21R	5.4+19R	5.2+17R	5.7+15R
	VSC2 @ 18"	q	1912	1880	1654	1667	1677	1534	1557	1575	1472
		F	1.7+47R	2.4+38R	3.3+31R	3.5+27R	3.7+24R	4.2+21R	4.3+19R	4.3+17R	4.7+16R
	VSC2 @ 12"	q	2156	2085	2035	1998	1969	1946	1928	1912	1899
		F	1.2+48R	1.9+38R	2.4+32R	2.7+27R	3+24R	3.2+21R	3.4+19R	3.5+17R	3.6+16R
	VSC2 @ 8"	q	2501	2512	2426	2446	2384	2406	2358	2310	1941
		F	0.7+48R	1.2+38R	1.7+32R	2+27R	2.3+24R	2.4+21R	2.6+19R	2.7+17R	2.8+16R
	VSC2 @ 6"	q	2716	2689	2669	2654	2643	2634	2627	2310	1941
		F	0.3+48R	0.9+38R	1.4+32R	1.7+27R	1.9+24R	2+21R	2.2+19R	2.3+17R	2.4+16R
	VSC2 @ 4"	q	2948	2936	2927	2921	2916	2912	2795	2310	1941
		F	-0.1+48R	0.6+38R	1+32R	1.2+27R	1.5+24R	1.6+21R	1.8+19R	1.9+17R	2+16R

See footnotes on page 28.

Type PLB™ -36

- 36/5 Weld Pattern at Supports
- Sidelaps Connected with PunchLok II Tool



Allowable Diaphragm Shear Strength, q (plf) and Flexibility Factors, F ((in./lb)x10⁶)

DECK GAGE	SIDELAP ATTACHMENT	SPAN (ft.-in.)									
		4'-0"	5'-0"	6'-0"	7'-0"	8'-0"	9'-0"	10'-0"	11'-0"	12'-0"	
22	VSC2 @ 24"	q	651	649	555	568	501	520	470		
		F	-1.1+189R	1.7+151R	4.6+125R	5.9+107R	7.9+93R	8.6+82R	10.2+74R		
	VSC2 @ 18"	q	776	751	648	647	646	584	590		
		F	-2.1+190R	0.8+151R	3.6+125R	4.9+107R	6+94R	7.6+83R	8.2+74R		
	VSC2 @ 12"	q	886	842	812	789	772	758	747		
		F	-2.8+190R	0.1+152R	2.1+126R	3.5+108R	4.6+94R	5.5+84R	6.2+75R		
	VSC2 @ 8"	q	1060	1059	1006	1013	976	986	958		
		F	-3.8+190R	-1.3+152R	0.7+127R	1.8+109R	3+95R	3.6+84R	4.4+76R		
	VSC2 @ 6"	q	1186	1163	1147	1135	1126	1118	1001		
		F	-4.5+191R	-1.9+152R	-0.2+127R	1.1+109R	2+95R	2.8+85R	3.3+76R		
	VSC2 @ 4"	q	1344	1332	1323	1317	1312	1236	1001		
		F	-5.3+191R	-2.8+153R	-1.1+127R	0+109R	0.9+95R	1.6+85R	2.2+76R		
20	VSC2 @ 24"	q	896	893	766	784	697	719	654	677	625
		F	1.4+119R	3.1+95R	5.2+79R	5.9+67R	7.4+58R	7.7+52R	8.9+46R	9+42R	10+38R
	VSC2 @ 18"	q	1063	1029	892	890	889	806	814	820	762
		F	0.5+120R	2.3+96R	4.3+79R	5.1+68R	5.7+59R	6.9+52R	7.2+47R	7.5+43R	8.3+39R
	VSC2 @ 12"	q	1207	1150	1110	1080	1057	1039	1025	1012	912
		F	-0.2+120R	1.7+96R	3+80R	3.9+68R	4.6+60R	5.2+53R	5.6+48R	6+43R	6.3+40R
	VSC2 @ 8"	q	1431	1429	1362	1371	1324	1336	1300	1085	912
		F	-1+120R	0.5+96R	1.8+80R	2.5+69R	3.3+60R	3.7+53R	4.2+48R	4.4+44R	4.8+40R
	VSC2 @ 6"	q	1589	1560	1540	1525	1514	1504	1313	1085	912
		F	-1.6+121R	0+96R	1.1+80R	1.9+69R	2.5+60R	3+54R	3.3+48R	3.6+44R	3.9+40R
	VSC2 @ 4"	q	1781	1767	1756	1749	1743	1621	1313	1085	912
		F	-2.2+121R	-0.7+97R	0.4+81R	1.1+69R	1.7+60R	2.1+54R	2.5+48R	2.7+44R	3+40R
18	VSC2 @ 24"	q	1443	1429	1229	1250	1114	1144	1042	1074	994
		F	2.6+58R	3.3+46R	4.5+38R	4.6+33R	5.5+29R	5.5+25R	6.2+23R	6.1+21R	6.6+19R
	VSC2 @ 18"	q	1693	1634	1420	1413	1408	1278	1287	1295	1203
		F	1.8+59R	2.6+47R	3.7+39R	4+33R	4.3+29R	4.9+26R	5+23R	5.1+21R	5.5+19R
	VSC2 @ 12"	q	1907	1815	1750	1701	1663	1633	1609	1589	1394
		F	1.3+59R	2.2+47R	2.8+39R	3.2+33R	3.5+29R	3.8+26R	4+23R	4.2+21R	4.3+19R
	VSC2 @ 8"	q	2238	2231	2127	2138	2066	2082	2007	1659	1394
		F	0.7+59R	1.4+47R	2+39R	2.3+34R	2.7+29R	2.9+26R	3.1+24R	3.2+21R	3.4+20R
	VSC2 @ 6"	q	2471	2425	2393	2369	2350	2335	2007	1659	1394
		F	0.3+59R	1.1+47R	1.6+39R	2+34R	2.3+29R	2.5+26R	2.7+24R	2.8+21R	2.9+20R
	VSC2 @ 4"	q	2752	2729	2712	2700	2690	2478	2007	1659	1394
		F	-0.1+59R	0.7+47R	1.2+39R	1.5+34R	1.8+30R	2+26R	2.2+24R	2.3+21R	2.4+20R
16	VSC2 @ 24"	q	1864	1859	1603	1638	1462	1506	1374	1420	1315
		F	3.1+33R	3.5+26R	4.4+22R	4.4+19R	5.1+16R	5+14R	5.5+13R	5.4+12R	5.8+11R
	VSC2 @ 18"	q	2196	2130	1856	1854	1852	1684	1700	1713	1594
		F	2.4+33R	2.9+27R	3.7+22R	3.9+19R	4+16R	4.5+14R	4.5+13R	4.5+12R	4.9+11R
	VSC2 @ 12"	q	2474	2365	2288	2230	2185	2150	2121	2097	1941
		F	2+33R	2.5+27R	2.9+22R	3.2+19R	3.4+17R	3.5+15R	3.6+13R	3.8+12R	3.8+11R
	VSC2 @ 8"	q	2895	2892	2768	2785	2697	2720	2653	2310	1941
		F	1.5+34R	1.9+27R	2.3+22R	2.4+19R	2.7+17R	2.7+15R	2.9+13R	3+12R	3.1+11R
	VSC2 @ 6"	q	3182	3131	3095	3068	3047	3030	2795	2310	1941
		F	1.1+34R	1.6+27R	1.9+22R	2.1+19R	2.3+17R	2.4+15R	2.5+13R	2.6+12R	2.7+11R
	VSC2 @ 4"	q	3518	3493	3475	3462	3452	3444	2795	2310	1941
		F	0.8+34R	1.2+27R	1.5+22R	1.7+19R	1.9+17R	2+15R	2.1+13R	2.2+12R	2.3+11R

See footnotes on page 28.

Type PLB™ -36

- 36/7/4 Weld Pattern at Supports
- Sidelaps Connected with PunchLok II Tool

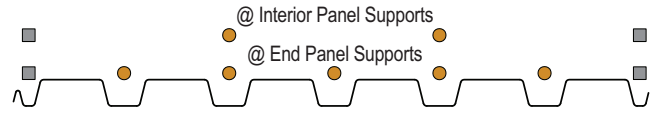

Allowable Diaphragm Shear Strength, q (plf) and Flexibility Factors, F ((in./lb)x10⁶)

DECK GAGE	SIDELAP ATTACHMENT	SPAN (ft.-in.)									
		4'-0"	5'-0"	6'-0"	7'-0"	8'-0"	9'-0"	10'-0"	11'-0"	12'-0"	
22	VSC2 @ 24"	q	651	653	543	561	487	510	459		
		F	9.3+27R	10+21R	11.8+16R	12.1+14R	13.5+11R	13.5+10R	14.7+8R		
	VSC2 @ 18"	q	796	770	655	657	658	587	598		
		F	8.2+28R	9+22R	10.6+17R	11+14R	11.3+12R	12.4+10R	12.5+9R		
	VSC2 @ 12"	q	929	880	846	821	802	788	776		
		F	7.4+28R	8.3+22R	8.9+18R	9.5+15R	9.9+13R	10.2+11R	10.5+10R		
	VSC2 @ 8"	q	1159	1161	1091	1103	1056	1069	1001		
		F	6.3+29R	6.8+23R	7.5+19R	7.7+16R	8.1+14R	8.2+12R	8.5+11R		
	VSC2 @ 6"	q	1343	1311	1289	1273	1261	1236	1001		
		F	5.6+29R	6.2+23R	6.6+19R	6.9+17R	7.1+14R	7.3+13R	7.4+11R		
	VSC2 @ 4"	q	1601	1581	1568	1558	1550	1236	1001		
		F	4.7+30R	5.2+24R	5.5+20R	5.7+17R	5.9+15R	6.1+13R	6.2+12R		
20	VSC2 @ 24"	q	902	906	764	789	687	715	643	673	617
		F	8.1+17R	8.5+13R	9.8+10R	9.9+8R	11+6R	10.9+6R	11.8+5R	11.6+4R	12.4+3R
	VSC2 @ 18"	q	1100	1066	908	910	911	819	829	838	774
		F	7+17R	7.6+13R	8.8+10R	9+9R	9.1+8R	10+6R	10+6R	10+5R	10.7+4R
	VSC2 @ 12"	q	1281	1214	1168	1135	1109	1089	1073	1059	912
		F	6.3+18R	6.9+14R	7.3+11R	7.7+10R	7.9+8R	8.1+7R	8.3+6R	8.4+6R	8.6+5R
	VSC2 @ 8"	q	1589	1592	1499	1514	1451	1469	1313	1085	912
		F	5.4+18R	5.6+15R	6.1+12R	6.2+10R	6.5+9R	6.5+8R	6.8+7R	6.8+6R	6.9+6R
	VSC2 @ 6"	q	1831	1790	1761	1740	1724	1621	1313	1085	912
		F	4.8+19R	5.1+15R	5.4+12R	5.6+10R	5.7+9R	5.8+8R	5.9+7R	6+7R	6+6R
	VSC2 @ 4"	q	2164	2139	2122	2109	2052	1621	1313	1085	912
		F	4.1+19R	4.4+15R	4.6+13R	4.7+11R	4.8+9R	4.9+8R	5+7R	5+7R	5.1+6R
18	VSC2 @ 24"	q	1462	1457	1235	1264	1116	1153	1037	1079	989
		F	5.9+8R	5.9+6R	6.7+5R	6.6+4R	7.2+3R	7+3R	7.6+2R	7.3+2R	7.8+2R
	VSC2 @ 18"	q	1768	1704	1454	1451	1449	1303	1317	1328	1226
		F	5+8R	5.2+7R	5.9+5R	5.9+4R	5.9+4R	6.4+3R	6.3+3R	6.3+3R	6.7+2R
	VSC2 @ 12"	q	2047	1934	1857	1800	1757	1723	1695	1659	1394
		F	4.5+9R	4.7+7R	4.9+6R	5+5R	5.1+4R	5.2+4R	5.3+3R	5.3+3R	5.4+3R
	VSC2 @ 8"	q	2522	2519	2370	2390	2289	2314	2007	1659	1394
		F	3.8+9R	3.9+7R	4.1+6R	4.1+5R	4.3+4R	4.3+4R	4.4+4R	4.4+3R	4.4+3R
	VSC2 @ 6"	q	2896	2826	2777	2741	2713	2478	2007	1659	1394
		F	3.4+9R	3.6+7R	3.7+6R	3.8+5R	3.8+5R	3.9+4R	3.9+4R	3.9+3R	4+3R
	VSC2 @ 4"	q	3411	3369	3339	3318	3136	2478	2007	1659	1394
		F	3+9R	3.1+7R	3.2+6R	3.3+5R	3.3+5R	3.4+4R	3.4+4R	3.4+3R	3.4+3R
16	VSC2 @ 24"	q	1897	1906	1618	1665	1472	1526	1383	1436	1320
		F	5+4R	5+3R	5.7+2R	5.5+2R	6.1+1R	5.9+1R	6.4+1R	6.2+1R	6.5+1R
	VSC2 @ 18"	q	2307	2236	1911	1915	1918	1727	1749	1766	1632
		F	4.3+5R	4.4+4R	5+3R	5+2R	5+2R	5.4+2R	5.3+1R	5.2+1R	5.6+1R
	VSC2 @ 12"	q	2676	2541	2447	2378	2326	2285	2252	2224	1941
		F	3.8+5R	4+4R	4.1+3R	4.2+3R	4.3+2R	4.4+2R	4.4+2R	4.4+2R	4.5+1R
	VSC2 @ 8"	q	3293	3298	3114	3145	3019	3055	2795	2310	1941
		F	3.3+5R	3.3+4R	3.5+3R	3.5+3R	3.6+2R	3.6+2R	3.6+2R	3.6+2R	3.7+2R
	VSC2 @ 6"	q	3767	3686	3630	3589	3558	3451	2795	2310	1941
		F	2.9+5R	3+4R	3.1+3R	3.1+3R	3.2+3R	3.2+2R	3.2+2R	3.3+2R	3.3+2R
	VSC2 @ 4"	q	4398	4352	4319	4296	4278	3451	2795	2310	1941
		F	2.6+5R	2.6+4R	2.7+4R	2.7+3R	2.8+3R	2.8+2R	2.8+2R	2.8+2R	2.8+2R

See footnotes on page 28.

Type PLB™ -36

- 36/7 Weld Pattern at Supports
- Sidelaps Connected with PunchLok II Tool



Allowable Diaphragm Shear Strength, q (plf) and Flexibility Factors, F ((in./lb)x10⁶)

DECK GAGE	SIDELAP ATTACHMENT	SPAN (ft.-in.)									
		4'-0"	5'-0"	6'-0"	7'-0"	8'-0"	9'-0"	10'-0"	11'-0"	12'-0"	
22	VSC2 @ 24"	q	700	693	581	594	516	535	482		
		F	8+28R	8.9+22R	10.4+18R	10.8+15R	12+12R	12.2+11R	13.3+9R		
	VSC2 @ 18"	q	842	808	688	685	682	613	618		
		F	7.2+29R	8.1+23R	9.5+18R	10+15R	10.3+13R	11.3+11R	11.5+10R		
	VSC2 @ 12"	q	971	914	875	847	825	808	794		
		F	6.6+29R	7.6+23R	8.2+19R	8.8+16R	9.2+14R	9.5+12R	9.8+11R		
	VSC2 @ 8"	q	1193	1188	1116	1123	1074	1085	1001		
		F	5.8+30R	6.4+24R	7+19R	7.3+17R	7.7+14R	7.8+13R	8.2+11R		
	VSC2 @ 6"	q	1370	1334	1309	1290	1276	1236	1001		
		F	5.2+30R	5.8+24R	6.3+20R	6.6+17R	6.8+15R	7+13R	7.2+12R		
	VSC2 @ 4"	q	1617	1595	1579	1568	1559	1236	1001		
		F	4.5+30R	5+24R	5.4+20R	5.6+17R	5.8+15R	5.9+13R	6.1+12R		
20	VSC2 @ 24"	q	970	960	815	830	727	751	676	703	644
		F	7.1+18R	7.6+14R	8.8+11R	9+9R	10+8R	10+7R	10.8+6R	10.7+5R	11.5+4R
	VSC2 @ 18"	q	1162	1116	953	949	945	850	857	863	797
		F	6.3+18R	6.9+14R	8+11R	8.2+10R	8.5+8R	9.2+7R	9.3+6R	9.4+6R	10+5R
	VSC2 @ 12"	q	1337	1261	1208	1170	1140	1117	1098	1082	912
		F	5.8+18R	6.4+14R	6.8+12R	7.2+10R	7.5+9R	7.7+8R	7.9+7R	8.1+6R	8.2+6R
	VSC2 @ 8"	q	1634	1627	1531	1541	1476	1491	1313	1085	912
		F	5+19R	5.4+15R	5.8+12R	6+10R	6.3+9R	6.3+8R	6.5+7R	6.6+7R	6.7+6R
	VSC2 @ 6"	q	1866	1819	1786	1762	1743	1621	1313	1085	912
		F	4.6+19R	4.9+15R	5.2+12R	5.4+11R	5.6+9R	5.7+8R	5.8+7R	5.9+7R	5.9+6R
	VSC2 @ 4"	q	2184	2156	2137	2122	2052	1621	1313	1085	912
		F	4+19R	4.3+15R	4.5+13R	4.6+11R	4.8+9R	4.9+8R	4.9+8R	5+7R	5+6R
18	VSC2 @ 24"	q	1575	1548	1315	1333	1179	1208	1092	1127	1035
		F	5.3+8R	5.5+7R	6.2+5R	6.1+4R	6.8+4R	6.6+3R	7.1+3R	7+3R	7.4+2R
	VSC2 @ 18"	q	1872	1789	1530	1517	1507	1356	1364	1371	1266
		F	4.7+9R	4.9+7R	5.5+6R	5.6+5R	5.6+4R	6.1+3R	6.1+3R	6+3R	6.4+3R
	VSC2 @ 12"	q	2141	2013	1924	1859	1809	1770	1738	1659	1394
		F	4.2+9R	4.5+7R	4.7+6R	4.8+5R	5+4R	5.1+4R	5.1+3R	5.2+3R	5.2+3R
	VSC2 @ 8"	q	2596	2579	2424	2436	2331	2352	2007	1659	1394
		F	3.7+9R	3.8+7R	4+6R	4+5R	4.2+5R	4.2+4R	4.3+4R	4.3+3R	4.4+3R
	VSC2 @ 6"	q	2954	2875	2820	2778	2747	2478	2007	1659	1394
		F	3.3+9R	3.5+7R	3.6+6R	3.7+5R	3.8+5R	3.8+4R	3.9+4R	3.9+3R	3.9+3R
	VSC2 @ 4"	q	3446	3398	3365	3340	3136	2478	2007	1659	1394
		F	2.9+9R	3.1+7R	3.2+6R	3.3+5R	3.3+5R	3.3+4R	3.4+4R	3.4+3R	3.4+3R
16	VSC2 @ 24"	q	2037	2018	1717	1749	1548	1593	1445	1492	1376
		F	4.6+5R	4.7+4R	5.3+3R	5.2+2R	5.7+2R	5.6+2R	6+1R	5.9+1R	6.2+1R
	VSC2 @ 18"	q	2434	2340	2005	1996	1989	1792	1807	1819	1682
		F	4+5R	4.2+4R	4.7+3R	4.7+3R	4.7+2R	5.1+2R	5.1+2R	5.1+1R	5.4+1R
	VSC2 @ 12"	q	2789	2635	2529	2450	2390	2342	2304	2272	1941
		F	3.6+5R	3.8+4R	4+3R	4.1+3R	4.2+2R	4.2+2R	4.3+2R	4.3+2R	4.4+2R
	VSC2 @ 8"	q	3381	3369	3178	3199	3069	3098	2795	2310	1941
		F	3.1+5R	3.2+4R	3.4+3R	3.4+3R	3.5+3R	3.5+2R	3.6+2R	3.6+2R	3.6+2R
	VSC2 @ 6"	q	3833	3743	3679	3632	3596	3451	2795	2310	1941
		F	2.9+5R	3+4R	3+3R	3.1+3R	3.1+3R	3.2+2R	3.2+2R	3.2+2R	3.2+2R
	VSC2 @ 4"	q	4436	4384	4347	4320	4300	3451	2795	2310	1941
		F	2.5+5R	2.6+4R	2.7+4R	2.7+3R	2.8+3R	2.8+2R	2.8+2R	2.8+2R	2.8+2R

See footnotes on page 28.

Type PLB™ -36

- 36/4 Hilti Fastener Pattern at Supports
X-EDNK22 or X-HSN 24 at supports equal to or greater than 1/8" and less than 3/16" thick
- Sidelaps Connected with PunchLok II Tool

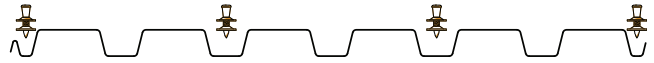

Allowable Diaphragm Shear Strength, q (plf) and Flexibility Factors, F ((in./lb)x10⁶)

DECK GAGE	SIDELAP ATTACHMENT	SPAN (ft.-in.)									
		4'-0"	5'-0"	6'-0"	7'-0"	8'-0"	9'-0"	10'-0"	11'-0"	12'-0"	
22	VSC2 @ 24"	q	467	486	436	457	420	439	409		
		F	-4.7+269R	-1.1+215R	2.8+178R	4.3+153R	6.9+133R	7.6+118R	9.6+106R		
	VSC2 @ 18"	q	543	544	498	506	512	481	489		
		F	-6+270R	-2.3+216R	1.4+179R	3.1+153R	4.4+134R	6.4+119R	7.1+107R		
	VSC2 @ 12"	q	592	585	579	575	572	570	568		
		F	-7+270R	-3.2+216R	-0.6+180R	1.3+154R	2.8+135R	3.9+120R	4.8+107R		
	VSC2 @ 8"	q	648	652	642	646	638	642	636		
		F	-8.3+271R	-4.9+217R	-2.2+180R	-0.7+155R	0.8+135R	1.7+120R	2.7+108R		
	VSC2 @ 6"	q	675	673	672	671	670	670	669		
		F	-9.1+271R	-5.6+217R	-3.2+181R	-1.5+155R	-0.2+135R	0.7+120R	1.5+108R		
	VSC2 @ 4"	q	699	699	698	698	697	697	697		
		F	-10+271R	-6.6+217R	-4.3+181R	-2.7+155R	-1.4+136R	-0.5+121R	0.3+109R		
20	VSC2 @ 24"	q	612	639	577	604	558	583	546	568	538
		F	-0.7+170R	1.5+136R	4.2+113R	5+96R	6.9+84R	7.2+75R	8.6+67R	8.6+61R	9.8+55R
	VSC2 @ 18"	q	707	710	655	666	674	636	646	654	626
		F	-1.9+171R	0.4+136R	2.9+113R	3.9+97R	4.7+85R	6.1+75R	6.5+68R	6.8+61R	7.8+56R
	VSC2 @ 12"	q	766	758	753	749	745	743	741	739	737
		F	-2.8+171R	-0.3+137R	1.3+114R	2.5+97R	3.4+85R	4.1+76R	4.7+68R	5.2+62R	5.6+57R
	VSC2 @ 8"	q	830	835	824	829	821	825	819	823	817
		F	-3.9+171R	-1.7+137R	0+114R	0.9+98R	1.9+86R	2.4+76R	3.1+68R	3.4+62R	3.9+57R
	VSC2 @ 6"	q	861	859	858	857	856	855	855	855	854
		F	-4.5+172R	-2.3+137R	-0.8+114R	0.3+98R	1.1+86R	1.7+76R	2.2+69R	2.6+62R	2.9+57R
	VSC2 @ 4"	q	887	886	886	886	885	885	885	885	885
		F	-5.3+172R	-3.1+137R	-1.6+115R	-0.6+98R	0.2+86R	0.8+76R	1.3+69R	1.7+62R	2+57R
18	VSC2 @ 24"	q	759	791	734	764	720	747	711	735	705
		F	1.6+83R	2.4+66R	3.9+55R	4.1+47R	5.1+41R	5.1+37R	5.9+33R	5.8+30R	6.4+27R
	VSC2 @ 18"	q	849	854	809	821	829	797	807	815	791
		F	0.6+83R	1.7+67R	3+55R	3.4+47R	3.7+42R	4.5+37R	4.6+33R	4.7+30R	5.2+28R
	VSC2 @ 12"	q	898	894	890	888	887	885	884	883	882
		F	0+84R	1.1+67R	1.9+56R	2.5+48R	2.9+42R	3.2+37R	3.5+33R	3.7+30R	3.9+28R
	VSC2 @ 8"	q	944	948	941	945	940	943	939	941	938
		F	-0.7+84R	0.3+67R	1.1+56R	1.5+48R	2+42R	2.3+37R	2.6+34R	2.7+30R	2.9+28R
	VSC2 @ 6"	q	964	963	963	962	962	962	961	961	961
		F	-1.1+84R	-0.1+67R	0.6+56R	1.2+48R	1.5+42R	1.8+37R	2.1+34R	2.3+31R	2.4+28R
	VSC2 @ 4"	q	980	980	980	979	979	979	979	979	979
		F	-1.6+84R	-0.5+67R	0.2+56R	0.7+48R	1+42R	1.3+37R	1.6+34R	1.8+31R	1.9+28R
16	VSC2 @ 24"	q	830	859	814	840	805	828	800	820	796
		F	2.7+47R	3.1+38R	4.2+31R	4.2+27R	4.9+23R	4.9+21R	5.4+19R	5.3+17R	5.8+15R
	VSC2 @ 18"	q	901	906	874	884	890	867	875	881	864
		F	1.8+47R	2.4+38R	3.4+31R	3.6+27R	3.7+24R	4.3+21R	4.3+19R	4.4+17R	4.8+16R
	VSC2 @ 12"	q	935	933	932	930	930	929	928	928	928
		F	1.3+48R	2+38R	2.4+32R	2.8+27R	3+24R	3.2+21R	3.4+19R	3.5+17R	3.6+16R
	VSC2 @ 8"	q	965	968	964	966	963	965	963	964	962
		F	0.7+48R	1.2+38R	1.7+32R	2+27R	2.3+24R	2.4+21R	2.6+19R	2.7+17R	2.8+16R
	VSC2 @ 6"	q	977	977	977	976	976	976	976	976	976
		F	0.3+48R	0.9+38R	1.4+32R	1.7+27R	1.9+24R	2.1+21R	2.2+19R	2.3+17R	2.4+16R
	VSC2 @ 4"	q	986	986	986	986	986	986	986	986	986
		F	0+48R	0.6+38R	1+32R	1.2+27R	1.5+24R	1.6+21R	1.8+19R	1.9+17R	2+16R

See footnotes on page 28.

Type PLB™ -36

- 36/7/4 Hilti Fastener Pattern at Supports
X-EDNK22 or X-HSN 24 at supports equal to or greater than 1/8" and less than 3/16" thick
- Sidelaps Connected with PunchLok II Tool

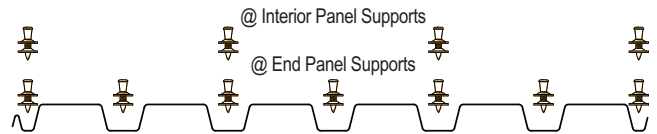

Allowable Diaphragm Shear Strength, q (plf) and Flexibility Factors, F ((in./lb)x10⁶)

DECK GAGE	SIDELAP ATTACHMENT	SPAN (ft-in.)									
		4'-0"	5'-0"	6'-0"	7'-0"	8'-0"	9'-0"	10'-0"	11'-0"	12'-0"	
22	VSC2 @ 24"	q	579	605	523	551	493	519	475		
		F	9.6+27R	10.4+21R	12.2+16R	12.4+14R	13.9+11R	13.8+10R	15.1+8R		
	VSC2 @ 18"	q	712	710	622	634	642	587	599		
		F	8.4+28R	9.3+22R	10.9+17R	11.3+14R	11.5+12R	12.7+10R	12.8+9R		
	VSC2 @ 12"	q	818	797	782	771	763	756	751		
		F	7.6+28R	8.5+22R	9.1+18R	9.6+15R	10+13R	10.3+11R	10.6+10R		
	VSC2 @ 8"	q	965	975	943	954	932	942	924		
		F	6.4+29R	6.9+23R	7.6+19R	7.7+16R	8.2+14R	8.3+12R	8.6+11R		
	VSC2 @ 6"	q	1056	1048	1042	1038	1035	1032	1001		
		F	5.7+29R	6.2+23R	6.6+19R	6.9+17R	7.1+14R	7.3+13R	7.4+11R		
	VSC2 @ 4"	q	1150	1147	1145	1143	1141	1140	1001		
		F	4.7+30R	5.2+24R	5.5+20R	5.8+17R	5.9+15R	6.1+13R	6.2+12R		
20	VSC2 @ 24"	q	768	807	700	740	664	700	642	674	627
		F	8.3+16R	8.7+13R	10.1+10R	10.1+8R	11.3+6R	11.1+6R	12.1+5R	11.8+4R	12.7+3R
	VSC2 @ 18"	q	943	943	832	849	862	790	807	821	769
		F	7.2+17R	7.7+13R	9+10R	9.1+9R	9.3+8R	10.1+6R	10.1+6R	10.1+5R	10.8+4R
	VSC2 @ 12"	q	1078	1054	1037	1025	1015	1008	1002	997	912
		F	6.4+18R	7+14R	7.5+11R	7.8+10R	8+8R	8.2+7R	8.4+6R	8.5+6R	8.6+5R
	VSC2 @ 8"	q	1259	1273	1236	1249	1223	1236	1215	1085	912
		F	5.4+18R	5.7+15R	6.2+12R	6.3+10R	6.6+9R	6.6+8R	6.8+7R	6.8+6R	7+6R
	VSC2 @ 6"	q	1366	1357	1351	1347	1344	1341	1313	1085	912
		F	4.8+19R	5.2+15R	5.4+12R	5.6+10R	5.7+9R	5.8+8R	5.9+7R	6+7R	6.1+6R
	VSC2 @ 4"	q	1473	1469	1467	1465	1464	1463	1313	1085	912
		F	4.1+19R	4.4+15R	4.6+13R	4.7+11R	4.8+9R	4.9+8R	5+8R	5.1+7R	5.1+6R
18	VSC2 @ 24"	q	1004	1066	944	1001	912	962	892	936	879
		F	6+8R	6+6R	6.8+5R	6.7+4R	7.3+3R	7.1+3R	7.7+2R	7.4+2R	7.9+2R
	VSC2 @ 18"	q	1211	1221	1104	1129	1148	1070	1093	1110	1053
		F	5.1+8R	5.3+7R	6+5R	6+4R	6+4R	6.4+3R	6.4+3R	6.3+3R	6.7+2R
	VSC2 @ 12"	q	1351	1334	1323	1314	1308	1303	1299	1295	1292
		F	4.5+9R	4.8+7R	4.9+6R	5.1+5R	5.2+4R	5.2+4R	5.3+3R	5.4+3R	5.4+3R
	VSC2 @ 8"	q	1512	1526	1499	1511	1492	1503	1487	1497	1394
		F	3.8+9R	3.9+7R	4.1+6R	4.1+5R	4.3+4R	4.3+4R	4.4+4R	4.4+3R	4.5+3R
	VSC2 @ 6"	q	1594	1590	1587	1585	1583	1582	1581	1580	1394
		F	3.4+9R	3.6+7R	3.7+6R	3.8+5R	3.8+5R	3.9+4R	3.9+4R	3.9+3R	4+3R
	VSC2 @ 4"	q	1667	1665	1664	1664	1663	1663	1662	1659	1394
		F	3+9R	3.1+7R	3.2+6R	3.3+5R	3.3+5R	3.4+4R	3.4+4R	3.4+3R	3.4+3R
16	VSC2 @ 24"	q	1162	1232	1116	1178	1091	1145	1076	1123	1066
		F	5.2+4R	5.1+3R	5.8+2R	5.6+2R	6.2+1R	6+1R	6.4+1R	6.2+1R	6.6+1R
	VSC2 @ 18"	q	1360	1375	1273	1300	1319	1250	1273	1290	1238
		F	4.4+5R	4.5+4R	5.1+3R	5+2R	5+2R	5.4+2R	5.3+1R	5.3+1R	5.6+1R
	VSC2 @ 12"	q	1478	1469	1462	1457	1454	1451	1448	1446	1445
		F	3.9+5R	4+4R	4.2+3R	4.3+3R	4.3+2R	4.4+2R	4.4+2R	4.5+2R	4.5+1R
	VSC2 @ 8"	q	1599	1610	1592	1601	1588	1596	1586	1593	1585
		F	3.3+5R	3.3+4R	3.5+3R	3.5+3R	3.6+2R	3.6+2R	3.6+2R	3.6+2R	3.7+2R
	VSC2 @ 6"	q	1653	1651	1650	1649	1648	1648	1647	1647	1646
		F	2.9+5R	3+4R	3.1+3R	3.2+3R	3.2+3R	3.2+2R	3.2+2R	3.3+2R	3.3+2R
	VSC2 @ 4"	q	1699	1698	1697	1697	1697	1697	1696	1696	1696
		F	2.6+5R	2.7+4R	2.7+4R	2.7+3R	2.8+3R	2.8+2R	2.8+2R	2.8+2R	2.8+2R

See footnotes on page 28.

Type PLB™ -36

- 36/7 Hilti Fastener Pattern at Supports
X-EDNK22 or X-HSN 24 at supports equal to or greater than 1/8" and less than 3/16" thick
- Sidelaps Connected with PunchLok II Tool

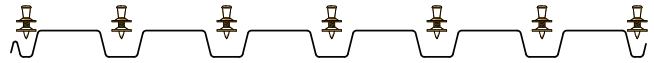

Allowable Diaphragm Shear Strength, q (plf) and Flexibility Factors, F ((in./lb)x10⁶)

DECK GAGE	SIDELAP ATTACHMENT	SPAN (ft.-in.)									
		4'-0"	5'-0"	6'-0"	7'-0"	8'-0"	9'-0"	10'-0"	11'-0"	12'-0"	
22	VSC2 @ 24"	q	607	627	543	568	509	533	488		
		F	8.3+28R	9.2+22R	10.7+18R	11.1+15R	12.4+12R	12.5+11R	13.6+9R		
	VSC2 @ 18"	q	734	728	639	648	655	599	610		
		F	7.5+29R	8.4+23R	9.8+18R	10.2+15R	10.6+13R	11.6+11R	11.8+10R		
	VSC2 @ 12"	q	835	811	795	782	773	765	759		
		F	6.8+29R	7.7+23R	8.4+19R	8.9+16R	9.4+14R	9.7+12R	10+11R		
	VSC2 @ 8"	q	976	983	951	961	938	947	929		
		F	5.9+30R	6.5+24R	7.1+19R	7.4+17R	7.8+14R	7.9+13R	8.3+11R		
	VSC2 @ 6"	q	1062	1053	1047	1042	1039	1036	1001		
		F	5.3+30R	5.9+24R	6.3+20R	6.7+17R	6.9+15R	7.1+13R	7.2+12R		
	VSC2 @ 4"	q	1153	1149	1147	1145	1143	1142	1001		
		F	4.6+30R	5.1+24R	5.4+20R	5.6+17R	5.8+15R	6+13R	6.1+12R		
20	VSC2 @ 24"	q	802	833	725	760	683	717	658	688	640
		F	7.3+18R	7.8+14R	9.1+11R	9.2+9R	10.2+8R	10.2+7R	11.1+6R	11+5R	11.7+4R
	VSC2 @ 18"	q	969	964	853	866	877	805	820	832	780
		F	6.5+18R	7.1+14R	8.2+11R	8.4+10R	8.6+8R	9.4+7R	9.5+6R	9.5+6R	10.2+5R
	VSC2 @ 12"	q	1098	1071	1052	1038	1027	1018	1011	1006	912
		F	5.9+18R	6.5+14R	7+12R	7.3+10R	7.6+9R	7.8+8R	8+7R	8.2+6R	8.3+6R
	VSC2 @ 8"	q	1271	1281	1244	1256	1230	1241	1221	1085	912
		F	5.1+19R	5.4+15R	5.9+12R	6+10R	6.3+9R	6.4+8R	6.6+7R	6.6+7R	6.8+6R
	VSC2 @ 6"	q	1373	1363	1357	1352	1348	1345	1313	1085	912
		F	4.6+19R	5+15R	5.3+12R	5.5+11R	5.6+9R	5.7+8R	5.8+7R	5.9+7R	6+6R
	VSC2 @ 4"	q	1476	1472	1469	1467	1466	1464	1313	1085	912
		F	4+19R	4.3+15R	4.5+13R	4.7+11R	4.8+9R	4.9+8R	4.9+8R	5+7R	5.1+6R
18	VSC2 @ 24"	q	1034	1087	966	1018	929	976	906	948	890
		F	5.5+8R	5.6+7R	6.3+5R	6.3+4R	6.9+4R	6.7+3R	7.2+3R	7.1+3R	7.5+2R
	VSC2 @ 18"	q	1231	1237	1121	1143	1159	1082	1103	1119	1062
		F	4.8+9R	5+7R	5.6+6R	5.7+5R	5.7+4R	6.2+4R	6.1+3R	6.1+3R	6.5+3R
	VSC2 @ 12"	q	1364	1346	1333	1323	1316	1310	1305	1301	1298
		F	4.3+9R	4.6+7R	4.7+6R	4.9+5R	5+4R	5.1+4R	5.2+3R	5.2+3R	5.3+3R
	VSC2 @ 8"	q	1519	1531	1504	1515	1495	1506	1490	1500	1394
		F	3.7+9R	3.8+7R	4+6R	4.1+5R	4.2+5R	4.2+4R	4.3+4R	4.3+3R	4.4+3R
	VSC2 @ 6"	q	1597	1593	1589	1587	1585	1583	1582	1581	1394
		F	3.3+9R	3.5+7R	3.6+6R	3.7+5R	3.8+5R	3.8+4R	3.9+4R	3.9+3R	3.9+3R
	VSC2 @ 4"	q	1668	1666	1665	1664	1664	1663	1663	1659	1394
		F	3+9R	3.1+7R	3.2+6R	3.3+5R	3.3+5R	3.4+4R	3.4+4R	3.4+3R	3.4+3R
16	VSC2 @ 24"	q	1184	1247	1132	1191	1104	1156	1087	1132	1075
		F	4.7+5R	4.8+4R	5.4+3R	5.3+2R	5.8+2R	5.7+2R	6.1+1R	5.9+1R	6.3+1R
	VSC2 @ 18"	q	1373	1385	1285	1309	1327	1258	1280	1296	1244
		F	4.1+5R	4.2+4R	4.8+3R	4.8+3R	4.8+2R	5.2+2R	5.1+2R	5.1+2R	5.4+1R
	VSC2 @ 12"	q	1486	1476	1468	1462	1458	1455	1452	1450	1448
		F	3.7+5R	3.9+4R	4+3R	4.1+3R	4.2+2R	4.3+2R	4.3+2R	4.4+2R	4.4+2R
	VSC2 @ 8"	q	1602	1612	1594	1603	1590	1598	1588	1594	1586
		F	3.2+5R	3.2+4R	3.4+3R	3.4+3R	3.5+3R	3.5+2R	3.6+2R	3.6+2R	3.6+2R
	VSC2 @ 6"	q	1655	1653	1651	1650	1649	1648	1648	1647	1647
		F	2.9+5R	3+4R	3.1+3R	3.1+3R	3.1+3R	3.2+2R	3.2+2R	3.2+2R	3.2+2R
	VSC2 @ 4"	q	1699	1698	1698	1697	1697	1697	1697	1697	1696
		F	2.5+5R	2.6+4R	2.7+4R	2.7+3R	2.8+3R	2.8+2R	2.8+2R	2.8+2R	2.8+2R

See footnotes on page 28.

Type PLB™-36

- 36/9 Hilti Fastener Pattern at Supports
X-EDNK22 or X-HSN 24 at supports equal to or greater than 1/8" and less than 3/16" thick
- Sidelaps Connected with PunchLok II Tool

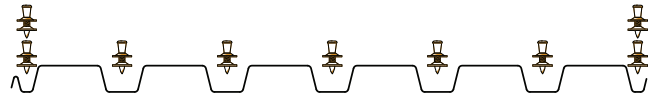

Allowable Diaphragm Shear Strength, q (plf) and Flexibility Factors, F ((in./lb)x10⁶)

DECK GAGE	SIDELAP ATTACHMENT	SPAN (ft-in.)									
		4'-0"	5'-0"	6'-0"	7'-0"	8'-0"	9'-0"	10'-0"	11'-0"	12'-0"	
22	VSC2 @ 24"	q	762	759	655	668	596	614	560		
		F	6.8+29R	7.7+23R	9+18R	9.5+15R	10.5+13R	10.8+11R	11.8+9R		
	VSC2 @ 18"	q	896	868	757	755	754	686	692		
		F	6.3+29R	7.2+23R	8.4+18R	8.9+16R	9.3+13R	10.2+11R	10.5+10R		
	VSC2 @ 12"	q	1007	963	931	907	889	874	862		
		F	5.9+29R	6.8+23R	7.5+19R	8+16R	8.5+14R	8.8+12R	9.2+11R		
	VSC2 @ 8"	q	1177	1175	1124	1131	1095	1104	1001		
		F	5.3+30R	5.9+24R	6.6+19R	6.9+17R	7.3+14R	7.5+13R	7.8+11R		
	VSC2 @ 6"	q	*1292	*1271	*1256	*1245	*1237	*1230	1001		
		F	4.9+30R	5.5+24R	6+20R	6.3+17R	6.6+15R	6.8+13R	6.9+12R		
	VSC2 @ 4"	q	*1427	*1417	*1409	*1404	*1400	*1236	1001		
		F	4.3+30R	4.8+24R	5.2+20R	5.4+17R	5.7+15R	5.8+13R	5.9+12R		
20	VSC2 @ 24"	q	999	1002	867	890	796	823	752	778	722
		F	6.1+18R	6.7+14R	7.7+11R	8+9R	8.9+8R	9+7R	9.8+6R	9.8+5R	10.4+4R
	VSC2 @ 18"	q	1177	1147	1005	1006	1008	919	929	937	874
		F	5.6+18R	6.3+14R	7.2+11R	7.5+10R	7.8+8R	8.5+7R	8.6+6R	8.7+6R	9.3+5R
	VSC2 @ 12"	q	1322	1270	1233	1205	1184	1167	1153	1085	912
		F	5.3+18R	5.9+14R	6.3+12R	6.7+10R	7+9R	7.2+8R	7.5+7R	7.6+6R	7.8+5R
	VSC2 @ 8"	q	*1536	*1537	1477	1487	1445	1457	1313	1085	912
		F	4.7+19R	5.1+15R	5.5+12R	5.7+10R	6+9R	6.1+8R	6.3+7R	6.4+6R	6.5+6R
	VSC2 @ 6"	q	*1676	*1653	*1637	*1625	*1616	*1609	1313	1085	912
		F	4.3+19R	4.7+15R	5+12R	5.2+11R	5.4+9R	5.5+8R	5.6+7R	5.7+7R	5.8+6R
	VSC2 @ 4"	q	*1834	*1823	*1816	*1810	*1806	*1621	1313	1085	912
		F	3.8+19R	4.2+15R	4.4+13R	4.5+11R	4.7+9R	4.8+8R	4.9+8R	4.9+7R	5+6R
18	VSC2 @ 24"	q	1257	1291	1135	1181	1068	1113	1026	1068	998
		F	4.8+8R	5+7R	5.7+5R	5.7+4R	6.2+4R	6.2+3R	6.7+3R	6.6+2R	7+2R
	VSC2 @ 18"	q	1481	1468	1313	1328	1339	1238	1257	1273	1198
		F	4.3+9R	4.6+7R	5.2+5R	5.3+5R	5.3+4R	5.8+3R	5.8+3R	5.8+3R	6.1+2R
	VSC2 @ 12"	q	1647	1607	1579	1558	1542	1529	1518	1510	1394
		F	4+9R	4.3+7R	4.5+6R	4.6+5R	4.8+4R	4.9+4R	5+3R	5+3R	5.1+3R
	VSC2 @ 8"	q	*1860	*1870	*1823	*1836	*1802	*1816	*1789	1659	1394
		F	3.5+9R	3.7+7R	3.9+6R	3.9+5R	4.1+4R	4.1+4R	4.2+4R	4.2+3R	4.3+3R
	VSC2 @ 6"	q	*1981	*1968	*1959	*1952	*1947	*1943	*1940	1659	1394
		F	3.2+9R	3.4+7R	3.5+6R	3.6+5R	3.7+5R	3.8+4R	3.8+4R	3.8+3R	3.9+3R
	VSC2 @ 4"	q	*2100	*2095	*2091	*2089	*2087	*2085	*2007	1659	1394
		F	2.9+9R	3+7R	3.1+6R	3.2+5R	3.3+5R	3.3+4R	3.4+4R	3.4+3R	3.4+3R
16	VSC2 @ 24"	q	1426	1481	1327	1387	1272	1328	1237	1288	1214
		F	4.2+5R	4.3+4R	4.8+3R	4.8+2R	5.3+2R	5.2+2R	5.6+1R	5.5+1R	5.9+1R
	VSC2 @ 18"	q	1659	1659	1516	1540	1557	1460	1484	1502	1430
		F	3.7+5R	3.9+4R	4.4+3R	4.5+2R	4.5+2R	4.9+2R	4.9+2R	4.9+1R	5.1+1R
	VSC2 @ 12"	q	*1813	*1787	*1769	*1756	*1745	*1737	*1730	*1724	*1719
		F	3.4+5R	3.6+4R	3.8+3R	3.9+3R	4+2R	4.1+2R	4.2+2R	4.2+2R	4.3+1R
	VSC2 @ 8"	q	*1988	*2000	*1968	*1980	*1956	*1968	*1949	*1960	*1941
		F	3+5R	3.1+4R	3.3+3R	3.3+3R	3.4+2R	3.4+2R	3.5+2R	3.5+2R	3.6+2R
	VSC2 @ 6"	q	*2077	*2070	*2066	*2063	*2060	*2058	*2056	*2055	*1941
		F	2.8+5R	2.9+4R	3+3R	3+3R	3.1+3R	3.1+2R	3.2+2R	3.2+2R	3.2+2R
	VSC2 @ 4"	q	*2156	*2154	*2152	*2151	*2150	*2149	*2149	*2148	*1941
		F	2.5+5R	2.6+4R	2.6+4R	2.7+3R	2.7+3R	2.8+2R	2.8+2R	2.8+2R	2.8+2R

1. For diaphragm shear strengths in bold and marked with *, the fastening pattern shall be increased at the building perimeter, chords, collectors or other shear transfer elements to two fasteners per rib (i.e. 36/14 pattern) or shall be limited to 1200 plf, 1500 plf, 1700 plf, or 1700 plf for 22, 20, 18 or 16 gage steel deck, respectively. Bearing at supports shall allow for proper end distance and fastener spacing.
2. See additional footnotes on page 28.

Type PLB™ -36

- 36/4 Hilti Fastener Pattern at Supports
X-EDNK22 at Supports $\frac{3}{16}$ " through $\frac{1}{4}$ " thick
X-HSN 24 at Supports $\frac{3}{16}$ " through $\frac{3}{8}$ " thick
- Sidelaps Connected with PunchLok II Tool



Allowable Diaphragm Shear Strength, q (plf) and Flexibility Factors, F ((in./lb)x10⁶)

DECK GAGE	SIDELAP ATTACHMENT	SPAN (ft.-in.)									
		4'-0"	5'-0"	6'-0"	7'-0"	8'-0"	9'-0"	10'-0"	11'-0"	12'-0"	
22	VSC2 @ 24"	q	497	516	460	482	440	460	428		
		F	-4.7+269R	-1.1+215R	2.8+178R	4.3+153R	6.9+133R	7.6+118R	9.6+106R		
	VSC2 @ 18"	q	582	582	529	537	543	508	516		
		F	-6+270R	-2.3+216R	1.4+179R	3.1+153R	4.4+134R	6.4+119R	7.1+107R		
	VSC2 @ 12"	q	639	629	622	617	613	610	607		
		F	-7+270R	-3.2+216R	-0.6+180R	1.3+154R	2.8+135R	3.9+120R	4.8+107R		
	VSC2 @ 8"	q	706	710	698	702	693	698	690		
		F	-8.3+271R	-4.9+217R	-2.2+180R	-0.7+155R	0.8+135R	1.7+120R	2.7+108R		
	VSC2 @ 6"	q	740	738	736	734	733	733	732		
		F	-9.1+271R	-5.6+217R	-3.2+181R	-1.5+155R	-0.2+135R	0.7+120R	1.5+108R		
	VSC2 @ 4"	q	772	771	770	770	769	769	769		
		F	-10+271R	-6.6+217R	-4.3+181R	-2.7+155R	-1.4+136R	-0.5+121R	0.3+109R		
20	VSC2 @ 24"	q	631	658	593	620	572	597	558	581	549
		F	-0.7+170R	1.5+136R	4.2+113R	5+96R	6.9+84R	7.2+75R	8.6+67R	8.6+61R	9.8+55R
	VSC2 @ 18"	q	732	734	675	686	694	654	664	673	642
		F	-1.9+171R	0.4+136R	2.9+113R	3.9+97R	4.7+85R	6.1+75R	6.5+68R	6.8+61R	7.8+56R
	VSC2 @ 12"	q	796	787	780	775	771	768	766	764	762
		F	-2.8+171R	-0.3+137R	1.3+114R	2.5+97R	3.4+85R	4.1+76R	4.7+68R	5.2+62R	5.6+57R
	VSC2 @ 8"	q	866	871	859	864	855	860	853	857	851
		F	-3.9+171R	-1.7+137R	0+114R	0.9+98R	1.9+86R	2.4+76R	3.1+68R	3.4+62R	3.9+57R
	VSC2 @ 6"	q	900	898	896	895	894	894	893	893	892
		F	-4.5+172R	-2.3+137R	-0.8+114R	0.3+98R	1.1+86R	1.7+76R	2.2+69R	2.6+62R	2.9+57R
	VSC2 @ 4"	q	930	929	929	928	928	928	928	927	912
		F	-5.3+172R	-3.1+137R	-1.6+115R	-0.6+98R	0.2+86R	0.8+76R	1.3+69R	1.7+62R	2+57R
18	VSC2 @ 24"	q	886	925	844	882	820	855	805	836	795
		F	1.6+83R	2.4+66R	3.9+55R	4.1+47R	5.1+41R	5.1+37R	5.9+33R	5.8+30R	6.4+27R
	VSC2 @ 18"	q	1014	1019	949	964	975	926	940	951	915
		F	0.6+83R	1.7+67R	3+55R	3.4+47R	3.7+42R	4.5+37R	4.6+33R	4.7+30R	5.2+28R
	VSC2 @ 12"	q	1089	1081	1074	1070	1066	1063	1061	1059	1057
		F	0+84R	1.1+67R	1.9+56R	2.5+48R	2.9+42R	3.2+37R	3.5+33R	3.7+30R	3.9+28R
	VSC2 @ 8"	q	1167	1173	1161	1167	1158	1163	1155	1160	1154
		F	-0.7+84R	0.3+67R	1.1+56R	1.5+48R	2+42R	2.3+37R	2.6+34R	2.7+30R	2.9+28R
	VSC2 @ 6"	q	1203	1201	1200	1199	1198	1198	1197	1197	1197
		F	-1.1+84R	-0.1+67R	0.6+56R	1.2+48R	1.5+42R	1.8+37R	2.1+34R	2.3+31R	2.4+28R
	VSC2 @ 4"	q	1233	1233	1232	1232	1232	1232	1231	1231	1231
		F	-1.6+84R	-0.5+67R	0.2+56R	0.7+48R	1+42R	1.3+37R	1.6+34R	1.8+31R	1.9+28R
16	VSC2 @ 24"	q	1134	1184	1087	1135	1061	1104	1044	1083	1033
		F	2.7+47R	3.1+38R	4.2+31R	4.2+27R	4.9+23R	4.9+21R	5.4+19R	5.3+17R	5.8+15R
	VSC2 @ 18"	q	1286	1293	1213	1232	1245	1189	1206	1219	1176
		F	1.8+47R	2.4+38R	3.4+31R	3.6+27R	3.7+24R	4.3+21R	4.3+19R	4.4+17R	4.8+16R
	VSC2 @ 12"	q	1373	1364	1357	1353	1349	1346	1344	1342	1340
		F	1.3+48R	2+38R	2.4+32R	2.8+27R	3+24R	3.2+21R	3.4+19R	3.5+17R	3.6+16R
	VSC2 @ 8"	q	1459	1466	1453	1459	1449	1455	1447	1452	1446
		F	0.7+48R	1.2+38R	1.7+32R	2+27R	2.3+24R	2.4+21R	2.6+19R	2.7+17R	2.8+16R
	VSC2 @ 6"	q	1498	1496	1495	1494	1493	1492	1492	1492	1491
		F	0.3+48R	0.9+38R	1.4+32R	1.7+27R	1.9+24R	2.1+21R	2.2+19R	2.3+17R	2.4+16R
	VSC2 @ 4"	q	1529	1529	1528	1528	1528	1528	1528	1527	1527
		F	0+48R	0.6+38R	1+32R	1.2+27R	1.5+24R	1.6+21R	1.8+19R	1.9+17R	2+16R

See footnotes on page 28.

Type PLB™ -36

- 36/7/4 Hilti Fastener Pattern at Supports
X-EDNK22 at Supports 3/16" through 1/4" thick
X-HSN 24 at Supports 3/16" through 3/8" thick
- Sidelaps Connected with PunchLok II Tool

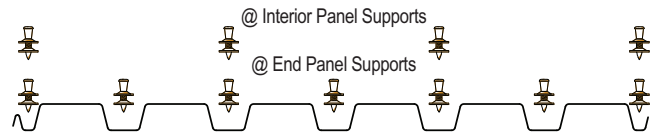

Allowable Diaphragm Shear Strength, q (plf) and Flexibility Factors, F ((in./lb)x10⁶)

DECK GAGE	SIDELAP ATTACHMENT	SPAN (ft-in.)									
		4'-0"	5'-0"	6'-0"	7'-0"	8'-0"	9'-0"	10'-0"	11'-0"	12'-0"	
22	VSC2 @ 24"	q	610	634	545	573	511	537	490		
		F	9.6+27R	10.4+21R	12.2+16R	12.4+14R	13.9+11R	13.8+10R	15.1+8R		
	VSC2 @ 18"	q	750	745	649	660	668	608	620		
		F	8.4+28R	9.3+22R	10.9+17R	11.3+14R	11.5+12R	12.7+10R	12.8+9R		
	VSC2 @ 12"	q	865	839	821	808	798	790	783		
		F	7.6+28R	8.5+22R	9.1+18R	9.6+15R	10+13R	10.3+11R	10.6+10R		
	VSC2 @ 8"	q	1032	1042	1003	1015	988	1000	979		
		F	6.4+29R	6.9+23R	7.6+19R	7.7+16R	8.2+14R	8.3+12R	8.6+11R		
	VSC2 @ 6"	q	1139	1128	1120	1115	1111	1107	1001		
		F	5.7+29R	6.2+23R	6.6+19R	6.9+17R	7.1+14R	7.3+13R	7.4+11R		
	VSC2 @ 4"	q	1256	1251	1247	1245	1243	1236	1001		
		F	4.7+30R	5.2+24R	5.5+20R	5.8+17R	5.9+15R	6.1+13R	6.2+12R		
20	VSC2 @ 24"	q	787	825	714	754	676	712	652	684	636
		F	8.3+16R	8.7+13R	10.1+10R	10.1+8R	11.3+6R	11.1+6R	12.1+5R	11.8+4R	12.7+3R
	VSC2 @ 18"	q	968	966	849	866	878	804	821	835	781
		F	7.2+17R	7.7+13R	9+10R	9.1+9R	9.3+8R	10.1+6R	10.1+6R	10.1+5R	10.8+4R
	VSC2 @ 12"	q	1109	1082	1063	1050	1039	1031	1024	1019	912
		F	6.4+18R	7+14R	7.5+11R	7.8+10R	8+8R	8.2+7R	8.4+6R	8.5+6R	8.6+5R
	VSC2 @ 8"	q	1302	1316	1275	1290	1261	1274	1252	1085	912
		F	5.4+18R	5.7+15R	6.2+12R	6.3+10R	6.6+9R	6.6+8R	6.8+7R	6.8+6R	7+6R
	VSC2 @ 6"	q	1418	1408	1402	1397	1393	1390	1313	1085	912
		F	4.8+19R	5.2+15R	5.4+12R	5.6+10R	5.7+9R	5.8+8R	5.9+7R	6+7R	6.1+6R
	VSC2 @ 4"	q	1537	1533	1530	1528	1527	1526	1313	1085	912
		F	4.1+19R	4.4+15R	4.6+13R	4.7+11R	4.8+9R	4.9+8R	5+8R	5.1+7R	5.1+6R
18	VSC2 @ 24"	q	1130	1193	1041	1103	994	1049	965	1014	946
		F	6+8R	6+6R	6.8+5R	6.7+4R	7.3+3R	7.1+3R	7.7+2R	7.4+2R	7.9+2R
	VSC2 @ 18"	q	1382	1387	1232	1259	1279	1179	1205	1225	1152
		F	5.1+8R	5.3+7R	6+5R	6+4R	6+4R	6.4+3R	6.4+3R	6.3+3R	6.7+2R
	VSC2 @ 12"	q	1568	1539	1519	1504	1493	1484	1476	1470	1394
		F	4.5+9R	4.8+7R	4.9+6R	5.1+5R	5.2+4R	5.2+4R	5.3+3R	5.4+3R	5.4+3R
	VSC2 @ 8"	q	1806	1825	1780	1798	1765	1782	1757	1659	1394
		F	3.8+9R	3.9+7R	4.1+6R	4.1+5R	4.3+4R	4.3+4R	4.4+4R	4.4+3R	4.5+3R
	VSC2 @ 6"	q	1939	1930	1924	1919	1916	1913	1911	1659	1394
		F	3.4+9R	3.6+7R	3.7+6R	3.8+5R	3.8+5R	3.9+4R	3.9+4R	3.9+3R	4+3R
	VSC2 @ 4"	q	2068	2064	2062	2060	2058	2057	2007	1659	1394
		F	3+9R	3.1+7R	3.2+6R	3.3+5R	3.3+5R	3.4+4R	3.4+4R	3.4+3R	3.4+3R
16	VSC2 @ 24"	q	1467	1553	1363	1445	1308	1381	1274	1338	1251
		F	5.2+4R	5.1+3R	5.8+2R	5.6+2R	6.2+1R	6+1R	6.4+1R	6.2+1R	6.6+1R
	VSC2 @ 18"	q	1785	1796	1607	1643	1670	1546	1580	1606	1515
		F	4.4+5R	4.5+4R	5.1+3R	5+2R	5+2R	5.4+2R	5.3+1R	5.3+1R	5.6+1R
	VSC2 @ 12"	q	2013	1981	1959	1943	1931	1921	1913	1906	1901
		F	3.9+5R	4+4R	4.2+3R	4.3+3R	4.3+2R	4.4+2R	4.4+2R	4.5+2R	4.5+1R
	VSC2 @ 8"	q	2292	2315	2264	2286	2249	2269	2240	2258	1941
		F	3.3+5R	3.3+4R	3.5+3R	3.5+3R	3.6+2R	3.6+2R	3.6+2R	3.6+2R	3.7+2R
	VSC2 @ 6"	q	2441	2432	2426	2421	2418	2415	2413	2310	1941
		F	2.9+5R	3+4R	3.1+3R	3.2+3R	3.2+3R	3.2+2R	3.2+2R	3.3+2R	3.3+2R
	VSC2 @ 4"	q	2581	2577	2575	2573	2572	2571	2570	2310	1941
		F	2.6+5R	2.7+4R	2.7+4R	2.7+3R	2.8+3R	2.8+2R	2.8+2R	2.8+2R	2.8+2R

See footnotes on page 28.

Type PLB™ -36

- 36/7 Hilti Fastener Pattern at Supports
X-EDNK22 at Supports 3/16" through 1/4" thick
X-HSN 24 at Supports 3/16" through 3/8" thick
- Sidelaps Connected with PunchLok II Tool



Allowable Diaphragm Shear Strength, q (plf) and Flexibility Factors, F ((in./lb)x10⁶)

DECK GAGE	SIDELAP ATTACHMENT	SPAN (ft.-in.)									
		4'-0"	5'-0"	6'-0"	7'-0"	8'-0"	9'-0"	10'-0"	11'-0"	12'-0"	
22	VSC2 @ 24"	q	642	659	568	592	529	552	505		
		F	8.3+28R	9.2+22R	10.7+18R	11.1+15R	12.4+12R	12.5+11R	13.6+9R		
	VSC2 @ 18"	q	777	766	669	677	683	622	633		
		F	7.5+29R	8.4+23R	9.8+18R	10.2+15R	10.6+13R	11.6+11R	11.8+10R		
	VSC2 @ 12"	q	887	857	837	822	810	801	793		
		F	6.8+29R	7.7+23R	8.4+19R	8.9+16R	9.4+14R	9.7+12R	10+11R		
	VSC2 @ 8"	q	1045	1052	1014	1024	996	1007	985		
		F	5.9+30R	6.5+24R	7.1+19R	7.4+17R	7.8+14R	7.9+13R	8.3+11R		
	VSC2 @ 6"	q	1148	1135	1127	1121	1116	1112	1001		
		F	5.3+30R	5.9+24R	6.3+20R	6.7+17R	6.9+15R	7.1+13R	7.2+12R		
	VSC2 @ 4"	q	1260	1254	1250	1247	1245	1236	1001		
		F	4.6+30R	5.1+24R	5.4+20R	5.6+17R	5.8+15R	6+13R	6.1+12R		
20	VSC2 @ 24"	q	823	853	740	775	696	729	669	699	650
		F	7.3+18R	7.8+14R	9.1+11R	9.2+9R	10.2+8R	10.2+7R	11.1+6R	11+5R	11.7+4R
	VSC2 @ 18"	q	996	989	872	885	895	820	835	847	793
		F	6.5+18R	7.1+14R	8.2+11R	8.4+10R	8.6+8R	9.4+7R	9.5+6R	9.5+6R	10.2+5R
	VSC2 @ 12"	q	1131	1101	1080	1064	1052	1042	1035	1028	912
		F	5.9+18R	6.5+14R	7+12R	7.3+10R	7.6+9R	7.8+8R	8+7R	8.2+6R	8.3+6R
	VSC2 @ 8"	q	1315	1326	1285	1298	1268	1281	1258	1085	912
		F	5.1+19R	5.4+15R	5.9+12R	6+10R	6.3+9R	6.4+8R	6.6+7R	6.6+7R	6.8+6R
	VSC2 @ 6"	q	1426	1415	1408	1402	1398	1394	1313	1085	912
		F	4.6+19R	5+15R	5.3+12R	5.5+11R	5.6+9R	5.7+8R	5.8+7R	5.9+7R	6+6R
	VSC2 @ 4"	q	1541	1536	1533	1531	1529	1527	1313	1085	912
		F	4+19R	4.3+15R	4.5+13R	4.7+11R	4.8+9R	4.9+8R	4.9+8R	5+7R	5.1+6R
18	VSC2 @ 24"	q	1174	1226	1073	1128	1019	1070	986	1032	963
		F	5.5+8R	5.6+7R	6.3+5R	6.3+4R	6.9+4R	6.7+3R	7.2+3R	7.1+3R	7.5+2R
	VSC2 @ 18"	q	1414	1413	1259	1281	1298	1198	1221	1240	1166
		F	4.8+9R	5+7R	5.6+6R	5.7+5R	5.7+4R	6.2+4R	6.1+3R	6.1+3R	6.5+3R
	VSC2 @ 12"	q	1592	1560	1537	1520	1507	1496	1488	1481	1394
		F	4.3+9R	4.6+7R	4.7+6R	4.9+5R	5+4R	5.1+4R	5.2+3R	5.2+3R	5.3+3R
	VSC2 @ 8"	q	1820	1835	1789	1806	1773	1788	1763	1659	1394
		F	3.7+9R	3.8+7R	4+6R	4.1+5R	4.2+5R	4.2+4R	4.3+4R	4.3+3R	4.4+3R
	VSC2 @ 6"	q	1947	1937	1929	1924	1920	1917	1914	1659	1394
		F	3.3+9R	3.5+7R	3.6+6R	3.7+5R	3.8+5R	3.8+4R	3.9+4R	3.9+3R	3.9+3R
	VSC2 @ 4"	q	2071	2067	2064	2062	2060	2059	2007	1659	1394
		F	3+9R	3.1+7R	3.2+6R	3.3+5R	3.3+5R	3.4+4R	3.4+4R	3.4+3R	3.4+3R
16	VSC2 @ 24"	q	1518	1591	1400	1475	1337	1405	1298	1359	1271
		F	4.7+5R	4.8+4R	5.4+3R	5.3+2R	5.8+2R	5.7+2R	6.1+1R	5.9+1R	6.3+1R
	VSC2 @ 18"	q	1822	1825	1637	1668	1691	1568	1598	1623	1531
		F	4.1+5R	4.2+4R	4.8+3R	4.8+3R	4.8+2R	5.2+2R	5.1+2R	5.1+2R	5.4+1R
	VSC2 @ 12"	q	2039	2004	1979	1960	1946	1935	1925	1918	1911
		F	3.7+5R	3.9+4R	4+3R	4.1+3R	4.2+2R	4.3+2R	4.3+2R	4.4+2R	4.4+2R
	VSC2 @ 8"	q	2305	2325	2274	2294	2257	2275	2247	2263	1941
		F	3.2+5R	3.2+4R	3.4+3R	3.4+3R	3.5+3R	3.5+2R	3.6+2R	3.6+2R	3.6+2R
	VSC2 @ 6"	q	2449	2439	2431	2426	2422	2419	2416	2310	1941
		F	2.9+5R	3+4R	3.1+3R	3.1+3R	3.1+3R	3.2+2R	3.2+2R	3.2+2R	3.2+2R
	VSC2 @ 4"	q	2584	2580	2577	2575	2574	2572	2571	2310	1941
		F	2.5+5R	2.6+4R	2.7+4R	2.7+3R	2.8+3R	2.8+2R	2.8+2R	2.8+2R	2.8+2R

See footnotes on page 28.

Type PLB™-36

- 36/9 Hilti Fastener Pattern at Supports
X-EDNK22 at Supports $\frac{3}{16}$ " through $\frac{1}{4}$ " thick
X-HSN 24 at Supports $\frac{3}{16}$ " through $\frac{3}{8}$ " thick
- Sidelaps Connected with PunchLok II Tool

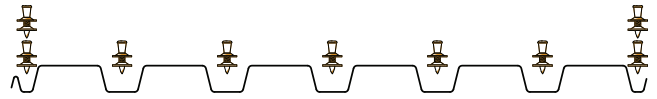

Allowable Diaphragm Shear Strength, q (plf) and Flexibility Factors, F ((in./lb)x10⁶)

DECK GAGE	SIDELAP ATTACHMENT	SPAN (ft-in.)									
		4'-0"	5'-0"	6'-0"	7'-0"	8'-0"	9'-0"	10'-0"	11'-0"	12'-0"	
22	VSC2 @ 24"	q	814	804	691	701	625	641	584		
		F	6.8+29R	7.7+23R	9+18R	9.5+15R	10.5+13R	10.8+11R	11.8+9R		
	VSC2 @ 18"	q	953	918	797	792	788	715	720		
		F	6.3+29R	7.2+23R	8.4+18R	8.9+16R	9.3+13R	10.2+11R	10.5+10R		
	VSC2 @ 12"	q	1073	1019	981	953	931	914	899		
		F	5.9+29R	6.8+23R	7.5+19R	8+16R	8.5+14R	8.8+12R	9.2+11R		
	VSC2 @ 8"	q	1259	1253	1193	1199	1157	1166	1001		
		F	5.3+30R	5.9+24R	6.6+19R	6.9+17R	7.3+14R	7.5+13R	7.8+11R		
	VSC2 @ 6"	q	*1390	*1363	*1344	*1330	*1319	1236	1001		
		F	4.9+30R	5.5+24R	6+20R	6.3+17R	6.6+15R	6.8+13R	6.9+12R		
	VSC2 @ 4"	q	*1551	*1537	*1527	*1520	*1514	1236	1001		
		F	4.3+30R	4.8+24R	5.2+20R	5.4+17R	5.7+15R	5.8+13R	5.9+12R		
20	VSC2 @ 24"	q	1030	1030	889	910	813	839	766	792	734
		F	6.1+18R	6.7+14R	7.7+11R	8+9R	8.9+8R	9+7R	9.8+6R	9.8+5R	10.4+4R
	VSC2 @ 18"	q	1212	1178	1029	1029	1029	937	947	954	889
		F	5.6+18R	6.3+14R	7.2+11R	7.5+10R	7.8+8R	8.5+7R	8.6+6R	8.7+6R	9.3+5R
	VSC2 @ 12"	q	1363	1306	1265	1235	1211	1192	1177	1085	912
		F	5.3+18R	5.9+14R	6.3+12R	6.7+10R	7+9R	7.2+8R	7.5+7R	7.6+6R	7.8+5R
	VSC2 @ 8"	q	1587	1587	1522	1532	1486	1498	1313	1085	912
		F	4.7+19R	5.1+15R	5.5+12R	5.7+10R	6+9R	6.1+8R	6.3+7R	6.4+6R	6.5+6R
	VSC2 @ 6"	q	*1738	*1712	*1694	*1680	*1670	*1621	1313	1085	912
		F	4.3+19R	4.7+15R	5+12R	5.2+11R	5.4+9R	5.5+8R	5.6+7R	5.7+7R	5.8+6R
	VSC2 @ 4"	q	*1910	*1898	*1889	*1883	*1878	*1621	1313	1085	912
		F	3.8+19R	4.2+15R	4.4+13R	4.5+11R	4.7+9R	4.8+8R	4.9+8R	4.9+7R	5+6R
18	VSC2 @ 24"	q	1448	1466	1275	1315	1180	1224	1121	1163	1081
		F	4.8+8R	5+7R	5.7+5R	5.7+4R	6.2+4R	6.2+3R	6.7+3R	6.6+2R	7+2R
	VSC2 @ 18"	q	1709	1676	1478	1486	1492	1366	1384	1399	1308
		F	4.3+9R	4.6+7R	5.2+5R	5.3+5R	5.3+4R	5.8+3R	5.8+3R	5.8+3R	6.1+2R
	VSC2 @ 12"	q	1916	1851	1805	1771	1744	1723	1705	1659	1394
		F	4+9R	4.3+7R	4.5+6R	4.6+5R	4.8+4R	4.9+4R	5+3R	5+3R	5.1+3R
	VSC2 @ 8"	q	*2207	*2214	*2139	*2154	*2101	*2118	2007	1659	1394
		F	3.5+9R	3.7+7R	3.9+6R	3.9+5R	4.1+4R	4.1+4R	4.2+4R	4.2+3R	4.3+3R
	VSC2 @ 6"	q	*2389	*2364	*2346	*2332	*2322	*2314	2007	1659	1394
		F	3.2+9R	3.4+7R	3.5+6R	3.6+5R	3.7+5R	3.8+4R	3.8+4R	3.8+3R	3.9+3R
	VSC2 @ 4"	q	*2585	*2574	*2566	*2560	*2555	*2478	2007	1659	1394
		F	2.9+9R	3+7R	3.1+6R	3.2+5R	3.3+5R	3.3+4R	3.4+4R	3.4+3R	3.4+3R
16	VSC2 @ 24"	q	1861	1896	1655	1714	1543	1604	1473	1531	1425
		F	4.2+5R	4.3+4R	4.8+3R	4.8+2R	5.3+2R	5.2+2R	5.6+1R	5.5+1R	5.9+1R
	VSC2 @ 18"	q	2196	2164	1918	1934	1946	1789	1814	1835	1720
		F	3.7+5R	3.9+4R	4.4+3R	4.5+2R	4.5+2R	4.9+2R	4.9+2R	4.9+1R	5.1+1R
	VSC2 @ 12"	q	2455	2383	2331	2292	2262	2238	2219	2203	1941
		F	3.4+5R	3.6+4R	3.8+3R	3.9+3R	4+2R	4.1+2R	4.2+2R	4.2+2R	4.3+1R
	VSC2 @ 8"	q	*2807	*2819	*2733	*2754	*2693	*2715	*2667	2310	1941
		F	3+5R	3.1+4R	3.3+3R	3.3+3R	3.4+2R	3.4+2R	3.5+2R	3.5+2R	3.6+2R
	VSC2 @ 6"	q	*3018	*2992	*2973	*2960	*2949	*2940	*2795	2310	1941
		F	2.8+5R	2.9+4R	3+3R	3+3R	3.1+3R	3.1+2R	3.2+2R	3.2+2R	3.2+2R
	VSC2 @ 4"	q	*3238	*3226	*3218	*3213	*3208	*3205	*2795	2310	1941
		F	2.5+5R	2.6+4R	2.6+4R	2.7+3R	2.7+3R	2.8+2R	2.8+2R	2.8+2R	2.8+2R

1. For diaphragm shear strengths in bold and marked with *, the fastening pattern shall be increased at the building perimeter, chords, collectors or other shear transfer elements to two fasteners per rib (i.e. 36/14 pattern) or shall be limited to 1300 plf, 1600 plf, 2100 plf, or 2600 plf for 22, 20, 18 or 16 gage steel deck, respectively. Bearing at supports shall allow for proper end distance and fastener spacing.
2. See additional footnotes on page 28.

Type PLB™ -36

- 36/4 Hilti Fastener Pattern at Supports
X-ENP19 at Supports ¼" thick and thicker
- Sidelaps Connected with PunchLok II Tool



Allowable Diaphragm Shear Strength, q (plf) and Flexibility Factors, F ((in./lb)x10⁶)

DECK GAGE	SIDELAP ATTACHMENT	SPAN (ft.-in.)									
		4'-0"	5'-0"	6'-0"	7'-0"	8'-0"	9'-0"	10'-0"	11'-0"	12'-0"	
22	VSC2 @ 24"	q	519	538	478	499	455	475	440		
		F	-6.9+270R	-3.1+215R	0.4+179R	2.2+153R	4.5+133R	5.5+118R	7.3+106R		
	VSC2 @ 18"	q	610	608	550	558	564	526	535		
		F	-7.6+270R	-3.8+216R	-0.4+179R	1.4+153R	2.9+134R	4.7+119R	5.6+107R		
	VSC2 @ 12"	q	673	661	653	646	641	637	634		
		F	-8.2+270R	-4.3+216R	-1.7+180R	0.3+154R	1.7+134R	2.9+119R	3.9+107R		
	VSC2 @ 8"	q	749	753	738	744	733	738	729		
		F	-9+271R	-5.5+216R	-2.9+180R	-1.2+154R	0.3+135R	1.2+120R	2.2+108R		
	VSC2 @ 6"	q	789	785	783	781	780	779	778		
		F	-9.6+271R	-6+217R	-3.6+180R	-1.9+155R	-0.6+135R	0.4+120R	1.2+108R		
	VSC2 @ 4"	q	826	825	824	823	823	823	822		
		F	-10.3+271R	-6.9+217R	-4.5+181R	-2.9+155R	-1.6+136R	-0.6+120R	0.1+108R		
20	VSC2 @ 24"	q	660	687	616	644	591	618	576	600	566
		F	-2.4+170R	0.1+136R	2.5+113R	3.6+96R	5.2+84R	5.8+75R	7+67R	7.3+61R	8.3+55R
	VSC2 @ 18"	q	769	770	704	715	724	679	690	699	666
		F	-3.1+171R	-0.6+136R	1.7+113R	2.9+97R	3.7+85R	5+75R	5.5+67R	5.9+61R	6.8+56R
	VSC2 @ 12"	q	840	829	821	815	811	807	804	801	799
		F	-3.6+171R	-1.1+137R	0.6+114R	1.8+97R	2.8+85R	3.5+75R	4.1+68R	4.6+62R	5.1+56R
	VSC2 @ 8"	q	921	927	912	918	907	912	904	909	902
		F	-4.4+171R	-2.1+137R	-0.4+114R	0.6+98R	1.6+85R	2.1+76R	2.8+68R	3.1+62R	3.6+57R
	VSC2 @ 6"	q	961	958	956	955	954	953	952	952	912
		F	-4.8+172R	-2.6+137R	-1.1+114R	0+98R	0.9+86R	1.5+76R	2+68R	2.4+62R	2.8+57R
	VSC2 @ 4"	q	997	996	995	995	994	994	994	994	912
		F	-5.4+172R	-3.2+137R	-1.8+114R	-0.7+98R	0.1+86R	0.7+76R	1.2+69R	1.6+62R	1.9+57R
18	VSC2 @ 24"	q	928	969	878	919	851	888	834	867	822
		F	0.7+83R	1.8+66R	3.1+55R	3.5+47R	4.4+41R	4.6+36R	5.3+33R	5.3+30R	5.9+27R
	VSC2 @ 18"	q	1068	1073	993	1010	1021	967	982	994	953
		F	0.1+83R	1.2+67R	2.5+55R	3+47R	3.3+41R	4+37R	4.2+33R	4.4+30R	4.9+27R
	VSC2 @ 12"	q	1154	1143	1135	1129	1125	1121	1118	1116	1114
		F	-0.4+84R	0.8+67R	1.6+56R	2.2+48R	2.7+42R	3+37R	3.3+33R	3.5+30R	3.7+28R
	VSC2 @ 8"	q	1245	1251	1236	1243	1232	1238	1229	1235	1227
		F	-0.9+84R	0.1+67R	0.9+56R	1.4+48R	1.9+42R	2.2+37R	2.5+33R	2.6+30R	2.9+28R
	VSC2 @ 6"	q	1287	1285	1283	1282	1281	1280	1280	1279	1279
		F	-1.3+84R	-0.2+67R	0.6+56R	1.1+48R	1.5+42R	1.8+37R	2+34R	2.2+30R	2.4+28R
	VSC2 @ 4"	q	1324	1323	1322	1322	1322	1321	1321	1321	1321
		F	-1.6+84R	-0.6+67R	0.1+56R	0.6+48R	1+42R	1.3+37R	1.5+34R	1.7+31R	1.9+28R
16	VSC2 @ 24"	q	1189	1242	1134	1185	1103	1149	1084	1125	1070
		F	2+47R	2.6+38R	3.5+31R	3.7+27R	4.4+23R	4.4+21R	4.9+18R	4.9+17R	5.3+15R
	VSC2 @ 18"	q	1357	1365	1273	1293	1308	1244	1263	1277	1229
		F	1.4+47R	2.1+38R	2.9+31R	3.2+27R	3.4+24R	3.9+21R	4+19R	4.1+17R	4.5+15R
	VSC2 @ 12"	q	1456	1445	1437	1431	1427	1423	1420	1418	1415
		F	1+48R	1.7+38R	2.2+32R	2.6+27R	2.8+24R	3.1+21R	3.2+19R	3.4+17R	3.5+16R
	VSC2 @ 8"	q	1558	1566	1549	1557	1545	1552	1542	1548	1541
		F	0.5+48R	1.1+38R	1.6+32R	1.9+27R	2.2+24R	2.3+21R	2.5+19R	2.6+17R	2.8+16R
	VSC2 @ 6"	q	1604	1601	1600	1599	1598	1597	1596	1596	1595
		F	0.2+48R	0.9+38R	1.3+32R	1.6+27R	1.8+24R	2+21R	2.1+19R	2.3+17R	2.4+16R
	VSC2 @ 4"	q	1642	1642	1641	1641	1640	1640	1640	1640	1640
		F	-0.1+48R	0.5+38R	0.9+32R	1.2+27R	1.4+24R	1.6+21R	1.7+19R	1.9+17R	2+16R

See footnotes on page 28.

Type PLB™-36

- 36/7/4 Hilti Fastener Pattern at Supports
- X-ENP19 at Supports 1/4" thick and thicker
- Sidelaps Connected with PunchLok II Tool

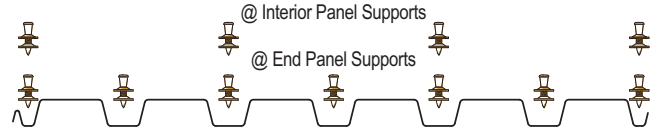

Allowable Diaphragm Shear Strength, q (plf) and Flexibility Factors, F ((in./lb)x10⁶)

DECK GAGE	SIDELAP ATTACHMENT	SPAN (ft-in.)									
		4'-0"	5'-0"	6'-0"	7'-0"	8'-0"	9'-0"	10'-0"	11'-0"	12'-0"	
22	VSC2 @ 24"	q	633	654	561	588	524	549	501		
		F	7.5+28R	8.4+21R	9.8+17R	10.3+14R	11.4+11R	11.7+10R	12.7+8R		
	VSC2 @ 18"	q	778	770	668	678	685	623	634		
		F	6.8+28R	7.8+22R	9+17R	9.6+14R	10+12R	10.9+10R	11.2+9R		
	VSC2 @ 12"	q	899	869	849	833	822	813	805		
		F	6.4+29R	7.3+22R	8+18R	8.5+15R	8.9+13R	9.3+11R	9.6+10R		
	VSC2 @ 8"	q	1079	1089	1046	1058	1028	1040	1001		
		F	5.6+29R	6.2+23R	6.9+19R	7.2+16R	7.6+14R	7.7+12R	8.1+11R		
	VSC2 @ 6"	q	1198	1185	1176	1169	1164	1160	1001		
		F	5.1+29R	5.7+23R	6.2+19R	6.5+16R	6.8+14R	7+13R	7.1+11R		
	VSC2 @ 4"	q	1333	1327	1322	1319	1317	1236	1001		
		F	4.4+30R	5+24R	5.3+20R	5.6+17R	5.8+15R	5.9+13R	6+12R		
20	VSC2 @ 24"	q	817	852	735	774	693	729	666	699	649
		F	6.7+17R	7.3+13R	8.4+10R	8.6+8R	9.6+7R	9.6+6R	10.4+5R	10.4+4R	11.1+3R
	VSC2 @ 18"	q	1004	1000	875	891	903	825	842	855	798
		F	6.1+17R	6.7+14R	7.7+11R	8+9R	8.2+8R	9+6R	9.1+5R	9.2+5R	9.8+4R
	VSC2 @ 12"	q	1155	1124	1102	1086	1074	1064	1056	1050	912
		F	5.6+18R	6.2+14R	6.7+11R	7+9R	7.3+8R	7.6+7R	7.8+6R	7.9+6R	8.1+5R
	VSC2 @ 8"	q	1366	1380	1334	1349	1316	1331	1306	1085	912
		F	4.9+18R	5.3+14R	5.7+12R	5.9+10R	6.2+9R	6.3+8R	6.5+7R	6.5+6R	6.7+6R
	VSC2 @ 6"	q	1497	1486	1477	1471	1466	1463	1313	1085	912
		F	4.5+19R	4.9+15R	5.2+12R	5.4+10R	5.5+9R	5.6+8R	5.7+7R	5.8+6R	5.9+6R
	VSC2 @ 4"	q	1636	1631	1628	1625	1623	1621	1313	1085	912
		F	3.9+19R	4.2+15R	4.5+12R	4.6+11R	4.7+9R	4.8+8R	4.9+7R	5+7R	5+6R
18	VSC2 @ 24"	q	1172	1233	1072	1134	1020	1076	988	1037	966
		F	5.1+8R	5.3+6R	6+5R	6+4R	6.6+3R	6.5+3R	7+2R	6.9+2R	7.3+2R
	VSC2 @ 18"	q	1436	1439	1272	1299	1319	1212	1238	1259	1181
		F	4.5+8R	4.8+7R	5.4+5R	5.5+4R	5.6+4R	6+3R	6+3R	6+2R	6.3+2R
	VSC2 @ 12"	q	1638	1604	1580	1562	1549	1538	1530	1523	1394
		F	4.1+9R	4.4+7R	4.6+6R	4.8+5R	4.9+4R	5+4R	5.1+3R	5.2+3R	5.2+3R
	VSC2 @ 8"	q	1903	1923	1870	1890	1852	1871	1842	1659	1394
		F	3.6+9R	3.7+7R	4+6R	4+5R	4.2+4R	4.2+4R	4.3+3R	4.3+3R	4.4+3R
	VSC2 @ 6"	q	2055	2044	2036	2030	2026	2022	2007	1659	1394
		F	3.3+9R	3.5+7R	3.6+6R	3.7+5R	3.8+4R	3.8+4R	3.8+4R	3.9+3R	3.9+3R
	VSC2 @ 4"	q	2207	2202	2199	2196	2195	2193	2007	1659	1394
		F	2.9+9R	3.1+7R	3.2+6R	3.2+5R	3.3+5R	3.3+4R	3.4+4R	3.4+3R	3.4+3R
16	VSC2 @ 24"	q	1521	1607	1405	1488	1343	1417	1305	1371	1279
		F	4.4+4R	4.5+3R	5.1+2R	5.1+2R	5.6+1R	5.5+1R	5.9+1R	5.8+1R	6.1+1R
	VSC2 @ 18"	q	1858	1866	1661	1698	1725	1592	1626	1654	1556
		F	3.9+5R	4.1+3R	4.6+3R	4.6+2R	4.7+2R	5+1R	5+1R	5+1R	5.3+1R
	VSC2 @ 12"	q	2106	2069	2043	2023	2008	1997	1987	1979	1941
		F	3.6+5R	3.8+4R	3.9+3R	4+2R	4.1+2R	4.2+2R	4.3+2R	4.3+1R	4.3+1R
	VSC2 @ 8"	q	2419	2444	2385	2409	2367	2389	2355	2310	1941
		F	3.1+5R	3.2+4R	3.4+3R	3.4+3R	3.5+2R	3.5+2R	3.6+2R	3.6+2R	3.6+2R
	VSC2 @ 6"	q	2592	2581	2573	2567	2562	2559	2556	2310	1941
		F	2.8+5R	3+4R	3+3R	3.1+3R	3.1+2R	3.2+2R	3.2+2R	3.2+2R	3.2+2R
	VSC2 @ 4"	q	2758	2753	2750	2748	2746	2745	2744	2310	1941
		F	2.5+5R	2.6+4R	2.7+3R	2.7+3R	2.7+3R	2.8+2R	2.8+2R	2.8+2R	2.8+2R

See footnotes on page 28.

Type PLB™ -36

- 36/7 Hilti Fastener Pattern at Supports
X-ENP19 at Supports ¼" thick and thicker
- Sidelaps Connected with PunchLok II Tool



Allowable Diaphragm Shear Strength, q (plf) and Flexibility Factors, F ((in./lb)x10⁶)

DECK GAGE	SIDELAP ATTACHMENT	SPAN (ft.-in.)									
		4'-0"	5'-0"	6'-0"	7'-0"	8'-0"	9'-0"	10'-0"	11'-0"	12'-0"	
22	VSC2 @ 24"	q	668	682	587	609	544	567	517		
		F	6.4+29R	7.3+23R	8.5+18R	9.1+15R	10+13R	10.4+11R	11.2+10R		
	VSC2 @ 18"	q	808	794	691	697	702	639	649		
		F	6+29R	6.9+23R	8+18R	8.6+16R	9+13R	9.8+11R	10.1+10R		
	VSC2 @ 12"	q	924	890	867	849	836	825	817		
		F	5.7+29R	6.5+23R	7.2+19R	7.8+16R	8.2+14R	8.6+12R	8.9+11R		
	VSC2 @ 8"	q	1095	1102	1058	1068	1037	1048	1001		
		F	5.1+30R	5.8+24R	6.4+19R	6.7+17R	7.1+14R	7.3+13R	7.6+11R		
	VSC2 @ 6"	q	1209	1194	1184	1176	1170	1166	1001		
		F	4.7+30R	5.4+24R	5.8+20R	6.2+17R	6.4+15R	6.7+13R	6.8+12R		
	VSC2 @ 4"	q	1338	1331	1326	1322	1320	1236	1001		
		F	4.2+30R	4.7+24R	5.1+20R	5.4+17R	5.6+15R	5.8+13R	5.9+12R		
20	VSC2 @ 24"	q	857	883	764	798	715	748	685	715	664
		F	5.8+18R	6.4+14R	7.4+11R	7.7+9R	8.5+8R	8.7+7R	9.4+6R	9.5+5R	10.1+4R
	VSC2 @ 18"	q	1037	1026	900	913	922	842	857	869	812
		F	5.4+18R	6+14R	6.9+11R	7.2+10R	7.5+8R	8.2+7R	8.3+6R	8.5+6R	9+5R
	VSC2 @ 12"	q	1180	1145	1121	1103	1089	1078	1069	1061	912
		F	5.1+18R	5.7+14R	6.2+12R	6.5+10R	6.8+9R	7.1+8R	7.3+7R	7.5+6R	7.6+5R
	VSC2 @ 8"	q	1382	1392	1345	1359	1326	1339	1313	1085	912
		F	4.6+19R	5+15R	5.4+12R	5.6+10R	5.9+9R	6+8R	6.2+7R	6.3+6R	6.5+6R
	VSC2 @ 6"	q	1507	1494	1484	1477	1472	1468	1313	1085	912
		F	4.2+19R	4.6+15R	4.9+12R	5.2+11R	5.3+9R	5.5+8R	5.6+7R	5.7+7R	5.7+6R
	VSC2 @ 4"	q	1641	1635	1631	1628	1625	1621	1313	1085	912
		F	3.8+19R	4.1+15R	4.3+13R	4.5+11R	4.6+9R	4.7+8R	4.8+8R	4.9+7R	5+6R
18	VSC2 @ 24"	q	1220	1270	1108	1163	1048	1099	1010	1057	985
		F	4.6+9R	4.9+7R	5.5+5R	5.6+4R	6.1+4R	6+3R	6.5+3R	6.4+2R	6.8+2R
	VSC2 @ 18"	q	1474	1469	1302	1324	1340	1233	1257	1276	1197
		F	4.2+9R	4.5+7R	5+5R	5.1+5R	5.2+4R	5.6+3R	5.7+3R	5.7+3R	6+2R
	VSC2 @ 12"	q	1666	1628	1601	1581	1565	1553	1543	1535	1394
		F	3.9+9R	4.2+7R	4.4+6R	4.6+5R	4.7+4R	4.8+4R	4.9+3R	5+3R	5+3R
	VSC2 @ 8"	q	1919	1935	1882	1900	1862	1879	1849	1659	1394
		F	3.5+9R	3.6+7R	3.8+6R	3.9+5R	4.1+4R	4.1+4R	4.2+4R	4.2+3R	4.3+3R
	VSC2 @ 6"	q	2065	2052	2043	2036	2031	2027	2007	1659	1394
		F	3.2+9R	3.4+7R	3.5+6R	3.6+5R	3.7+5R	3.7+4R	3.8+4R	3.8+3R	3.9+3R
	VSC2 @ 4"	q	2210	2205	2202	2199	2197	2195	2007	1659	1394
		F	2.9+9R	3+7R	3.1+6R	3.2+5R	3.3+5R	3.3+4R	3.3+4R	3.4+3R	3.4+3R
16	VSC2 @ 24"	q	1579	1650	1446	1522	1376	1445	1331	1394	1301
		F	4+5R	4.2+4R	4.7+3R	4.7+2R	5.1+2R	5.1+2R	5.5+1R	5.4+1R	5.7+1R
	VSC2 @ 18"	q	1901	1900	1695	1727	1749	1616	1648	1673	1575
		F	3.6+5R	3.8+4R	4.3+3R	4.4+2R	4.4+2R	4.8+2R	4.8+2R	4.8+1R	5+1R
	VSC2 @ 12"	q	2137	2095	2065	2043	2026	2013	2002	1993	1941
		F	3.3+5R	3.6+4R	3.7+3R	3.9+3R	4+2R	4+2R	4.1+2R	4.2+2R	4.2+1R
	VSC2 @ 8"	q	2436	2457	2397	2419	2376	2397	2363	2310	1941
		F	3+5R	3.1+4R	3.2+3R	3.3+3R	3.4+2R	3.4+2R	3.5+2R	3.5+2R	3.6+2R
	VSC2 @ 6"	q	2602	2589	2580	2573	2568	2564	2561	2310	1941
		F	2.8+5R	2.9+4R	3+3R	3+3R	3.1+3R	3.1+2R	3.1+2R	3.2+2R	3.2+2R
	VSC2 @ 4"	q	2762	2756	2753	2750	2748	2747	2746	2310	1941
		F	2.5+5R	2.6+4R	2.6+4R	2.7+3R	2.7+3R	2.7+2R	2.8+2R	2.8+2R	2.8+2R

See footnotes on page 28.

Type PLB™ -36

- 36/4 Pneutek Fastener Pattern at Supports
SDK61 at Supports 0.113 to 0.155" thick
- Sidelaps Connected with PunchLok II Tool



Allowable Diaphragm Shear Strength, q (plf) and Flexibility Factors, F ((in./lb)x10⁶)

DECK GAGE	SIDELAP ATTACHMENT	SPAN (ft-in.)									
		4'-0"	5'-0"	6'-0"	7'-0"	8'-0"	9'-0"	10'-0"	11'-0"	12'-0"	
22	VSC2 @ 24"	q	504	524	466	487	445	465	432		
		F	-0.6+269R	2.1+215R	6.6+178R	7.4+153R	10.4+133R	10.4+119R	12.7+106R		
	VSC2 @ 18"	q	591	590	536	544	550	514	522		
		F	-3.5+270R	-0.1+216R	3.9+179R	5.3+154R	6.3+135R	8.5+119R	8.9+107R		
	VSC2 @ 12"	q	650	640	632	627	622	619	616		
		F	-5.3+271R	-1.6+216R	0.9+180R	2.6+154R	4+135R	5+120R	5.8+108R		
	VSC2 @ 8"	q	720	725	711	716	706	711	703		
		F	-7.3+271R	-4.1+217R	-1.5+181R	0+155R	1.4+135R	2.2+120R	3.2+108R		
	VSC2 @ 6"	q	756	753	751	750	749	748	747		
		F	-8.5+271R	-5.1+217R	-2.8+181R	-1.1+155R	0.1+136R	1.1+121R	1.8+108R		
	VSC2 @ 4"	q	790	788	788	787	787	786	786		
		F	-9.8+272R	-6.4+217R	-4.1+181R	-2.5+155R	-1.3+136R	-0.3+121R	0.4+109R		
20	VSC2 @ 24"	q	638	665	598	626	576	602	563	586	553
		F	2.1+170R	3.6+136R	6.7+113R	6.9+97R	9.1+84R	8.9+75R	10.5+67R	10.2+61R	11.5+56R
	VSC2 @ 18"	q	741	743	682	693	701	660	671	679	648
		F	-0.3+171R	1.8+137R	4.6+114R	5.3+97R	5.9+85R	7.4+76R	7.6+68R	7.8+62R	8.9+57R
	VSC2 @ 12"	q	807	797	790	785	781	778	775	773	771
		F	-1.7+171R	0.6+137R	2.2+114R	3.3+98R	4.1+86R	4.8+76R	5.3+68R	5.7+62R	6.1+57R
	VSC2 @ 8"	q	879	884	872	877	868	872	865	869	863
		F	-3.3+172R	-1.3+137R	0.4+114R	1.3+98R	2.3+86R	2.7+76R	3.4+69R	3.7+62R	4.1+57R
	VSC2 @ 6"	q	915	912	911	910	909	908	907	907	907
		F	-4.2+172R	-2+137R	-0.5+115R	0.5+98R	1.3+86R	1.9+76R	2.4+69R	2.8+62R	3.1+57R
	VSC2 @ 4"	q	946	945	945	944	944	944	944	943	912
		F	-5.1+172R	-3+138R	-1.5+115R	-0.5+98R	0.3+86R	0.9+76R	1.3+69R	1.7+63R	2+57R
18	VSC2 @ 24"	q	889	928	846	884	822	857	807	838	796
		F	2.8+83R	3.2+67R	4.9+55R	4.8+48R	5.9+41R	5.7+37R	6.6+33R	6.4+30R	7+28R
	VSC2 @ 18"	q	1017	1022	951	967	978	929	943	954	917
		F	1.2+84R	2.2+67R	3.6+56R	3.9+48R	4.1+42R	4.9+37R	5+33R	5+30R	5.6+28R
	VSC2 @ 12"	q	1093	1084	1078	1073	1070	1067	1064	1062	1061
		F	0.4+84R	1.5+67R	2.2+56R	2.7+48R	3.1+42R	3.4+37R	3.7+34R	3.9+30R	4.1+28R
	VSC2 @ 8"	q	1172	1178	1166	1171	1162	1167	1160	1164	1158
		F	-0.5+84R	0.4+67R	1.2+56R	1.6+48R	2.1+42R	2.3+37R	2.7+34R	2.8+31R	3+28R
	VSC2 @ 6"	q	1208	1206	1205	1204	1203	1203	1202	1202	1202
		F	-1+84R	0+67R	0.7+56R	1.2+48R	1.6+42R	1.9+37R	2.1+34R	2.3+31R	2.5+28R
	VSC2 @ 4"	q	1239	1238	1238	1237	1237	1237	1237	1237	1237
		F	-1.5+84R	-0.5+67R	0.2+56R	0.7+48R	1.1+42R	1.4+37R	1.6+34R	1.8+31R	1.9+28R
16	VSC2 @ 24"	q	1127	1176	1081	1128	1055	1098	1039	1077	1028
		F	3.6+47R	3.7+38R	4.9+31R	4.8+27R	5.6+24R	5.3+21R	6+19R	5.7+17R	6.3+16R
	VSC2 @ 18"	q	1277	1284	1205	1224	1237	1182	1199	1212	1170
		F	2.3+48R	2.8+38R	3.8+32R	3.9+27R	4+24R	4.6+21R	4.6+19R	4.6+17R	5+16R
	VSC2 @ 12"	q	1362	1353	1347	1343	1339	1336	1334	1332	1330
		F	1.6+48R	2.2+38R	2.7+32R	3+27R	3.2+24R	3.4+21R	3.5+19R	3.7+17R	3.8+16R
	VSC2 @ 8"	q	1447	1453	1441	1447	1437	1443	1435	1440	1434
		F	0.8+48R	1.3+38R	1.9+32R	2.1+27R	2.4+24R	2.5+21R	2.7+19R	2.7+17R	2.9+16R
	VSC2 @ 6"	q	1484	1483	1481	1480	1480	1479	1479	1478	1478
		F	0.4+48R	1+38R	1.4+32R	1.7+27R	1.9+24R	2.1+21R	2.2+19R	2.3+17R	2.4+16R
	VSC2 @ 4"	q	1515	1515	1514	1514	1514	1514	1514	1513	1513
		F	0+48R	0.6+38R	1+32R	1.3+27R	1.5+24R	1.7+21R	1.8+19R	1.9+17R	2+16R

See footnotes on page 28.

Type PLB™ -36

- 36/7/4 Pneutek Fastener Pattern at Supports
SDK61 at Supports 0.113 to 0.155" thick
- Sidelaps Connected with PunchLok II Tool

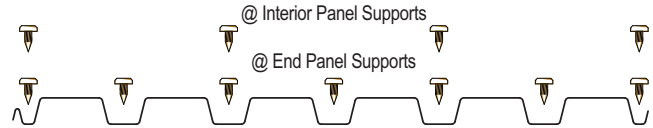

Allowable Diaphragm Shear Strength, q (plf) and Flexibility Factors, F ((in./lb)x10⁶)

DECK GAGE	SIDELAP ATTACHMENT	SPAN (ft.-in.)									
		4'-0"	5'-0"	6'-0"	7'-0"	8'-0"	9'-0"	10'-0"	11'-0"	12'-0"	
22	VSC2 @ 24"	q	618	640	550	578	515	541	494		
		F	13.8+26R	13.7+21R	16.2+16R	15.6+14R	17.5+11R	16.9+10R	18.5+8R		
	VSC2 @ 18"	q	760	753	655	666	673	613	625		
		F	11.1+28R	11.6+22R	13.6+17R	13.6+15R	13.6+13R	15+11R	14.8+10R		
	VSC2 @ 12"	q	876	849	830	816	806	797	791		
		F	9.4+29R	10.1+23R	10.7+19R	11+16R	11.3+14R	11.5+12R	11.7+11R		
	VSC2 @ 8"	q	1047	1057	1018	1030	1002	1013	992		
		F	7.4+29R	7.7+24R	8.4+19R	8.4+17R	8.8+15R	8.8+13R	9.1+12R		
	VSC2 @ 6"	q	1158	1147	1139	1133	1129	1125	1001		
		F	6.3+30R	6.8+24R	7.1+20R	7.3+17R	7.5+15R	7.6+13R	7.8+12R		
	VSC2 @ 4"	q	1281	1276	1272	1269	1267	1236	1001		
		F	5.1+30R	5.5+24R	5.8+20R	6+17R	6.1+15R	6.2+13R	6.3+12R		
20	VSC2 @ 24"	q	794	832	719	759	680	716	655	688	639
		F	11.2+16R	10.9+13R	12.8+10R	12.2+9R	13.6+7R	13+6R	14.2+5R	13.6+5R	14.6+4R
	VSC2 @ 18"	q	977	974	855	872	884	809	826	840	785
		F	9+17R	9.2+14R	10.7+11R	10.6+9R	10.5+8R	11.5+7R	11.3+6R	11.2+6R	12+5R
	VSC2 @ 12"	q	1120	1092	1073	1059	1048	1039	1032	1026	912
		F	7.6+18R	8.1+14R	8.4+12R	8.6+10R	8.8+9R	8.9+8R	9+7R	9.1+6R	9.2+6R
	VSC2 @ 8"	q	1318	1331	1289	1304	1274	1288	1265	1085	912
		F	6.1+19R	6.2+15R	6.6+12R	6.6+11R	6.9+9R	6.9+8R	7.1+7R	7.1+7R	7.2+6R
	VSC2 @ 6"	q	1437	1427	1420	1415	1411	1408	1313	1085	912
		F	5.2+19R	5.5+15R	5.7+13R	5.9+11R	6+9R	6+8R	6.1+8R	6.2+7R	6.2+6R
	VSC2 @ 4"	q	1561	1557	1554	1552	1550	1549	1313	1085	912
		F	4.3+19R	4.6+15R	4.7+13R	4.9+11R	5+10R	5+8R	5.1+8R	5.1+7R	5.2+6R
18	VSC2 @ 24"	q	1133	1195	1043	1105	996	1051	967	1015	947
		F	7.3+8R	6.8+7R	7.9+5R	7.4+5R	8.2+4R	7.8+3R	8.4+3R	8+3R	8.5+2R
	VSC2 @ 18"	q	1385	1390	1235	1262	1282	1182	1207	1228	1154
		F	5.8+9R	5.8+7R	6.6+6R	6.5+5R	6.4+4R	6.9+4R	6.8+3R	6.7+3R	7.1+3R
	VSC2 @ 12"	q	1573	1543	1523	1508	1496	1487	1480	1474	1394
		F	4.9+9R	5.1+7R	5.3+6R	5.4+5R	5.4+4R	5.5+4R	5.5+4R	5.6+3R	5.6+3R
	VSC2 @ 8"	q	1812	1831	1785	1804	1771	1788	1762	1659	1394
		F	4+9R	4.1+7R	4.3+6R	4.3+5R	4.4+5R	4.4+4R	4.5+4R	4.5+3R	4.5+3R
	VSC2 @ 6"	q	1946	1937	1931	1926	1923	1920	1917	1659	1394
		F	3.6+9R	3.7+7R	3.8+6R	3.8+5R	3.9+5R	3.9+4R	4+4R	4+3R	4+3R
	VSC2 @ 4"	q	2076	2072	2070	2068	2067	2066	2007	1659	1394
		F	3.1+9R	3.2+8R	3.3+6R	3.3+5R	3.4+5R	3.4+4R	3.4+4R	3.4+3R	3.5+3R
16	VSC2 @ 24"	q	1460	1546	1358	1440	1304	1376	1270	1334	1247
		F	6.2+4R	5.8+4R	6.6+3R	6.2+2R	6.9+2R	6.5+2R	7+1R	6.7+1R	7.1+1R
	VSC2 @ 18"	q	1776	1787	1600	1636	1663	1540	1574	1600	1510
		F	4.9+5R	4.9+4R	5.6+3R	5.4+3R	5.3+2R	5.8+2R	5.7+2R	5.6+2R	5.9+1R
	VSC2 @ 12"	q	2001	1970	1949	1933	1921	1911	1903	1897	1891
		F	4.2+5R	4.3+4R	4.4+3R	4.5+3R	4.5+2R	4.6+2R	4.6+2R	4.6+2R	4.6+2R
	VSC2 @ 8"	q	2276	2298	2249	2270	2234	2253	2225	2242	1941
		F	3.4+5R	3.4+4R	3.6+3R	3.6+3R	3.7+3R	3.6+2R	3.7+2R	3.7+2R	3.8+2R
	VSC2 @ 6"	q	2422	2413	2407	2403	2399	2397	2394	2310	1941
		F	3+5R	3.1+4R	3.2+4R	3.2+3R	3.2+3R	3.3+2R	3.3+2R	3.3+2R	3.3+2R
	VSC2 @ 4"	q	2559	2555	2553	2551	2550	2549	2548	2310	1941
		F	2.6+5R	2.7+4R	2.7+4R	2.8+3R	2.8+3R	2.8+2R	2.8+2R	2.8+2R	2.9+2R

See footnotes on page 28.

Type PLB™ -36

- 36/7 Pneutek Fastener Pattern at Supports
SDK61 at Supports 0.113 to 0.155" thick
- Sidelaps Connected with PunchLok II Tool



Allowable Diaphragm Shear Strength, q (plf) and Flexibility Factors, F ((in./lb)x10⁶)

DECK GAGE	SIDELAP ATTACHMENT	SPAN (ft-in.)									
		4'-0"	5'-0"	6'-0"	7'-0"	8'-0"	9'-0"	10'-0"	11'-0"	12'-0"	
22	VSC2 @ 24"	q	651	666	574	598	534	557	509		
		F	12.3+28R	12.6+22R	14.8+17R	14.5+15R	16.3+12R	15.9+11R	17.3+10R		
	VSC2 @ 18"	q	787	775	677	684	689	628	638		
		F	10.2+29R	10.8+23R	12.7+18R	12.8+16R	12.9+14R	14.2+12R	14.1+11R		
	VSC2 @ 12"	q	899	868	847	831	819	809	801		
		F	8.8+29R	9.6+23R	10.2+19R	10.6+16R	10.9+14R	11.1+13R	11.3+11R		
	VSC2 @ 8"	q	1062	1069	1028	1039	1010	1021	999		
		F	7.1+30R	7.4+24R	8.1+20R	8.2+17R	8.6+15R	8.6+13R	8.9+12R		
	VSC2 @ 6"	q	1168	1155	1146	1139	1134	1130	1001		
		F	6.1+30R	6.6+24R	6.9+20R	7.2+17R	7.4+15R	7.5+13R	7.7+12R		
	VSC2 @ 4"	q	1285	1279	1275	1272	1270	1236	1001		
		F	5+30R	5.4+24R	5.7+20R	5.9+17R	6.1+15R	6.2+13R	6.3+12R		
20	VSC2 @ 24"	q	831	860	746	781	701	734	672	703	653
		F	10.2+17R	10.2+14R	11.9+11R	11.5+9R	12.8+8R	12.4+7R	13.5+6R	13+6R	13.9+5R
	VSC2 @ 18"	q	1006	998	879	892	901	826	841	853	798
		F	8.4+18R	8.7+14R	10.1+11R	10.1+10R	10.1+9R	11.1+7R	10.9+7R	10.8+6R	11.6+5R
	VSC2 @ 12"	q	1143	1112	1090	1074	1061	1051	1043	1036	912
		F	7.2+18R	7.7+15R	8.1+12R	8.3+10R	8.5+9R	8.7+8R	8.8+7R	8.9+6R	9+6R
	VSC2 @ 8"	q	1331	1342	1300	1313	1282	1295	1271	1085	912
		F	5.9+19R	6+15R	6.5+12R	6.5+11R	6.8+9R	6.8+8R	7+7R	7+7R	7.1+6R
	VSC2 @ 6"	q	1446	1434	1426	1420	1416	1412	1313	1085	912
		F	5.1+19R	5.4+15R	5.6+13R	5.8+11R	5.9+9R	6+8R	6.1+8R	6.1+7R	6.2+6R
	VSC2 @ 4"	q	1565	1560	1556	1554	1552	1550	1313	1085	912
		F	4.2+19R	4.5+15R	4.7+13R	4.8+11R	4.9+10R	5+9R	5.1+8R	5.1+7R	5.1+6R
18	VSC2 @ 24"	q	1176	1228	1075	1131	1021	1072	987	1033	964
		F	6.8+8R	6.6+7R	7.5+5R	7.2+5R	7.9+4R	7.5+4R	8.2+3R	7.8+3R	8.3+3R
	VSC2 @ 18"	q	1418	1416	1261	1284	1301	1200	1224	1242	1168
		F	5.6+9R	5.6+7R	6.4+6R	6.3+5R	6.2+4R	6.8+4R	6.7+3R	6.6+3R	7+3R
	VSC2 @ 12"	q	1597	1564	1541	1524	1510	1500	1491	1484	1394
		F	4.8+9R	5+7R	5.2+6R	5.3+5R	5.3+4R	5.4+4R	5.4+4R	5.5+3R	5.5+3R
	VSC2 @ 8"	q	1826	1841	1795	1812	1778	1794	1768	1659	1394
		F	4+9R	4+7R	4.2+6R	4.2+5R	4.4+5R	4.3+4R	4.5+4R	4.4+3R	4.5+3R
	VSC2 @ 6"	q	1954	1944	1936	1931	1927	1924	1921	1659	1394
		F	3.5+9R	3.7+7R	3.8+6R	3.8+5R	3.9+5R	3.9+4R	3.9+4R	4+3R	4+3R
	VSC2 @ 4"	q	2079	2075	2072	2070	2068	2067	2007	1659	1394
		F	3+9R	3.2+8R	3.2+6R	3.3+5R	3.4+5R	3.4+4R	3.4+4R	3.4+3R	3.5+3R
16	VSC2 @ 24"	q	1510	1583	1394	1469	1332	1400	1294	1354	1267
		F	5.9+5R	5.6+4R	6.4+3R	6+3R	6.6+2R	6.3+2R	6.8+2R	6.5+2R	7+1R
	VSC2 @ 18"	q	1812	1815	1629	1661	1683	1561	1592	1616	1526
		F	4.7+5R	4.8+4R	5.4+3R	5.3+3R	5.2+2R	5.7+2R	5.6+2R	5.5+2R	5.8+2R
	VSC2 @ 12"	q	2026	1992	1967	1949	1935	1924	1915	1908	1902
		F	4.1+5R	4.2+4R	4.3+3R	4.4+3R	4.5+3R	4.5+2R	4.5+2R	4.6+2R	4.6+2R
	VSC2 @ 8"	q	2289	2308	2258	2278	2242	2260	2232	2248	1941
		F	3.4+5R	3.4+4R	3.6+3R	3.5+3R	3.6+3R	3.6+2R	3.7+2R	3.7+2R	3.7+2R
	VSC2 @ 6"	q	2429	2419	2413	2407	2403	2400	2398	2310	1941
		F	3+5R	3.1+4R	3.1+4R	3.2+3R	3.2+3R	3.2+2R	3.3+2R	3.3+2R	3.3+2R
	VSC2 @ 4"	q	2561	2558	2555	2553	2551	2550	2549	2310	1941
		F	2.6+5R	2.7+4R	2.7+4R	2.8+3R	2.8+3R	2.8+2R	2.8+2R	2.8+2R	2.9+2R

See footnotes on page 28.

Type PLB™ -36

- 36/9 Pneutek Fastener Pattern at Supports
SDK61 at Supports 0.113 to 0.155" thick
- Sidelaps Connected with PunchLok II Tool

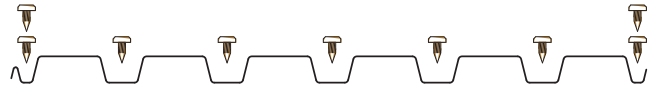

Allowable Diaphragm Shear Strength, q (plf) and Flexibility Factors, F ((in./lb)x10⁶)

DECK GAGE	SIDELAP ATTACHMENT	SPAN (ft.-in.)									
		4'-0"	5'-0"	6'-0"	7'-0"	8'-0"	9'-0"	10'-0"	11'-0"	12'-0"	
22	VSC2 @ 24"	q	827	815	700	710	632	647	589		
		F	10.4+28R	11+22R	13+17R	13.1+15R	14.6+12R	14.5+11R	15.8+9R		
	VSC2 @ 18"	q	968	930	807	801	796	722	726		
		F	9+29R	9.8+23R	11.4+18R	11.7+15R	11.9+13R	13.1+11R	13.2+10R		
	VSC2 @ 12"	q	1088	1033	993	964	941	923	908		
		F	8+29R	8.8+23R	9.4+19R	9.9+16R	10.3+14R	10.6+12R	10.8+11R		
	VSC2 @ 8"	q	1278	1272	1210	1215	1172	1180	1001		
		F	6.6+30R	7+24R	7.7+20R	7.9+17R	8.3+15R	8.4+13R	8.7+12R		
	VSC2 @ 6"	q	*1414	*1385	*1365	*1350	*1338	1236	1001		
		F	5.8+30R	6.3+24R	6.7+20R	7+17R	7.2+15R	7.4+13R	7.5+12R		
	VSC2 @ 4"	q	*1581	*1566	*1556	*1548	*1542	1236	1001		
		F	4.8+30R	5.3+24R	5.6+20R	5.8+17R	6+15R	6.1+13R	6.2+12R		
20	VSC2 @ 24"	q	1041	1040	898	918	820	845	771	797	738
		F	8.9+17R	9.2+14R	10.6+11R	10.5+9R	11.7+8R	11.5+7R	12.5+6R	12.2+5R	13+5R
	VSC2 @ 18"	q	1225	1189	1038	1038	1037	944	953	961	894
		F	7.6+18R	8+14R	9.3+11R	9.4+10R	9.5+8R	10.4+7R	10.4+6R	10.3+6R	11+5R
	VSC2 @ 12"	q	1378	1319	1277	1245	1221	1202	1186	1085	912
		F	6.7+18R	7.2+14R	7.6+12R	7.9+10R	8.2+9R	8.3+8R	8.5+7R	8.6+6R	8.7+6R
	VSC2 @ 8"	q	*1606	*1605	1538	1548	1501	1513	1313	1085	912
		F	5.6+19R	5.8+15R	6.3+12R	6.3+11R	6.6+9R	6.6+8R	6.9+7R	6.8+7R	7+6R
	VSC2 @ 6"	q	*1760	*1734	*1714	*1700	*1689	*1621	1313	1085	912
		F	4.9+19R	5.2+15R	5.5+13R	5.7+11R	5.8+9R	5.9+8R	6+8R	6+7R	6.1+6R
	VSC2 @ 4"	q	*1939	*1926	*1916	*1910	*1904	*1621	1313	1085	912
		F	4.1+19R	4.4+15R	4.6+13R	4.8+11R	4.9+10R	4.9+8R	5+8R	5.1+7R	5.1+6R
18	VSC2 @ 24"	q	1452	1470	1277	1317	1183	1226	1123	1165	1083
		F	6.3+8R	6.2+7R	7+5R	6.8+5R	7.5+4R	7.2+3R	7.8+3R	7.5+3R	8+2R
	VSC2 @ 18"	q	1714	1680	1481	1489	1495	1369	1387	1401	1310
		F	5.2+9R	5.4+7R	6.1+6R	6.1+5R	6+4R	6.5+4R	6.5+3R	6.4+3R	6.8+3R
	VSC2 @ 12"	q	1921	1856	1810	1775	1748	1726	1709	1659	1394
		F	4.6+9R	4.8+7R	5+6R	5.1+5R	5.2+4R	5.3+4R	5.3+4R	5.4+3R	5.4+3R
	VSC2 @ 8"	q	*2214	*2221	*2145	*2161	*2106	*2124	2007	1659	1394
		F	3.9+9R	3.9+7R	4.2+6R	4.2+5R	4.3+5R	4.3+4R	4.4+4R	4.4+3R	4.5+3R
	VSC2 @ 6"	q	*2398	*2372	*2354	*2340	*2330	*2321	2007	1659	1394
		F	3.5+9R	3.6+7R	3.7+6R	3.8+5R	3.8+5R	3.9+4R	3.9+4R	3.9+3R	4+3R
	VSC2 @ 4"	q	*2595	*2584	*2576	*2570	*2565	*2478	2007	1659	1394
		F	3+9R	3.1+8R	3.2+6R	3.3+5R	3.3+5R	3.4+4R	3.4+4R	3.4+3R	3.5+3R
16	VSC2 @ 24"	q	1850	1886	1647	1706	1537	1598	1468	1525	1420
		F	5.4+5R	5.2+4R	6+3R	5.7+2R	6.3+2R	6.1+2R	6.5+2R	6.3+1R	6.7+1R
	VSC2 @ 18"	q	2183	2152	1909	1926	1938	1782	1807	1828	1714
		F	4.5+5R	4.6+4R	5.2+3R	5.1+3R	5.1+2R	5.5+2R	5.4+2R	5.3+2R	5.7+1R
	VSC2 @ 12"	q	2440	2369	2318	2281	2251	2228	2209	2193	1941
		F	3.9+5R	4.1+4R	4.2+3R	4.3+3R	4.4+2R	4.4+2R	4.5+2R	4.5+2R	4.5+2R
	VSC2 @ 8"	q	*2788	*2800	*2716	*2737	*2676	*2698	*2651	2310	1941
		F	3.3+5R	3.3+4R	3.5+3R	3.5+3R	3.6+3R	3.6+2R	3.7+2R	3.6+2R	3.7+2R
	VSC2 @ 6"	q	*2995	*2970	*2952	*2938	*2928	*2920	*2795	2310	1941
		F	3+5R	3.1+4R	3.1+4R	3.2+3R	3.2+3R	3.2+2R	3.2+2R	3.3+2R	3.3+2R
	VSC2 @ 4"	q	*3211	*3200	*3192	*3186	*3182	*3179	*2795	2310	1941
		F	2.6+5R	2.7+4R	2.7+4R	2.7+3R	2.8+3R	2.8+2R	2.8+2R	2.8+2R	2.8+2R

- For diaphragm shear strengths in bold and marked with *, the fastening pattern shall be increased at the building perimeter, chords, collectors or other shear transfer elements to two fasteners per rib (i.e. 36/14 pattern) or shall be limited to 1300 plf, 1600 plf, 2100 plf, or 2600 plf for 22, 20, 18 or 16 gage steel deck, respectively. Bearing at supports shall allow for proper fastener spacing and end distance.
- See additional footnotes on page 28.

Type PLB™ -36

- 36/4 Pneutek Fastener Pattern at Supports
SDK63 at Supports 0.155 to 0.250" thick
- Sidelaps Connected with PunchLok II Tool



Allowable Diaphragm Shear Strength, q (plf) and Flexibility Factors, F ((in./lb)x10⁶)

DECK GAGE	SIDELAP ATTACHMENT	SPAN (ft-in.)									
		4'-0"	5'-0"	6'-0"	7'-0"	8'-0"	9'-0"	10'-0"	11'-0"	12'-0"	
22	VSC2 @ 24"	q	538	557	492	514	467	488	451		
		F	-0.6+269R	2.1+215R	6.6+178R	7.4+153R	10.4+133R	10.4+119R	12.7+106R		
	VSC2 @ 18"	q	634	631	568	576	582	541	550		
		F	-3.5+270R	-0.1+216R	3.9+179R	5.3+154R	6.3+135R	8.5+119R	8.9+107R		
	VSC2 @ 12"	q	702	688	678	671	665	661	657		
		F	-5.3+271R	-1.6+216R	0.9+180R	2.6+154R	4+135R	5+120R	5.8+108R		
	VSC2 @ 8"	q	786	791	773	779	767	772	762		
		F	-7.3+271R	-4.1+217R	-1.5+181R	0+155R	1.4+135R	2.2+120R	3.2+108R		
	VSC2 @ 6"	q	831	827	824	822	821	819	818		
		F	-8.5+271R	-5.1+217R	-2.8+181R	-1.1+155R	0.1+136R	1.1+121R	1.8+108R		
	VSC2 @ 4"	q	874	873	872	871	870	870	869		
		F	-9.8+272R	-6.4+217R	-4.1+181R	-2.5+155R	-1.3+136R	-0.3+121R	0.4+109R		
20	VSC2 @ 24"	q	668	695	622	651	597	624	581	605	570
		F	2.1+170R	3.6+136R	6.7+113R	6.9+97R	9.1+84R	8.9+75R	10.5+67R	10.2+61R	11.5+56R
	VSC2 @ 18"	q	779	780	712	723	732	686	697	706	672
		F	-0.3+171R	1.8+137R	4.6+114R	5.3+97R	5.9+85R	7.4+76R	7.6+68R	7.8+62R	8.9+57R
	VSC2 @ 12"	q	852	841	832	826	821	817	814	811	809
		F	-1.7+171R	0.6+137R	2.2+114R	3.3+98R	4.1+86R	4.8+76R	5.3+68R	5.7+62R	6.1+57R
	VSC2 @ 8"	q	936	942	926	932	921	927	918	923	912
		F	-3.3+172R	-1.3+137R	0.4+114R	1.3+98R	2.3+86R	2.7+76R	3.4+69R	3.7+62R	4.1+57R
	VSC2 @ 6"	q	978	975	973	971	970	969	969	968	912
		F	-4.2+172R	-2+137R	-0.5+115R	0.5+98R	1.3+86R	1.9+76R	2.4+69R	2.8+62R	3.1+57R
	VSC2 @ 4"	q	1016	1015	1014	1013	1013	1013	1012	1012	912
		F	-5.1+172R	-3+138R	-1.5+115R	-0.5+98R	0.3+86R	0.9+76R	1.3+69R	1.7+63R	2+57R
18	VSC2 @ 24"	q	898	938	853	892	829	864	813	845	802
		F	2.8+83R	3.2+67R	4.9+55R	4.8+48R	5.9+41R	5.7+37R	6.6+33R	6.4+30R	7+28R
	VSC2 @ 18"	q	1029	1034	961	977	988	938	952	963	925
		F	1.2+84R	2.2+67R	3.6+56R	3.9+48R	4.1+42R	4.9+37R	5+33R	5+30R	5.6+28R
	VSC2 @ 12"	q	1108	1098	1091	1086	1083	1079	1077	1075	1073
		F	0.4+84R	1.5+67R	2.2+56R	2.7+48R	3.1+42R	3.4+37R	3.7+34R	3.9+30R	4.1+28R
	VSC2 @ 8"	q	1189	1195	1182	1188	1178	1184	1176	1181	1174
		F	-0.5+84R	0.4+67R	1.2+56R	1.6+48R	2.1+42R	2.3+37R	2.7+34R	2.8+31R	3+28R
	VSC2 @ 6"	q	1227	1225	1223	1222	1221	1221	1220	1220	1219
		F	-1+84R	0+67R	0.7+56R	1.2+48R	1.6+42R	1.9+37R	2.1+34R	2.3+31R	2.5+28R
	VSC2 @ 4"	q	1259	1258	1257	1257	1257	1257	1256	1256	1256
		F	-1.5+84R	-0.5+67R	0.2+56R	0.7+48R	1.1+42R	1.4+37R	1.6+34R	1.8+31R	1.9+28R
16	VSC2 @ 24"	q	1106	1154	1063	1108	1039	1080	1023	1060	1013
		F	3.6+47R	3.7+38R	4.9+31R	4.8+27R	5.6+24R	5.3+21R	6+19R	5.7+17R	6.3+16R
	VSC2 @ 18"	q	1249	1257	1182	1200	1213	1160	1176	1189	1149
		F	2.3+48R	2.8+38R	3.8+32R	3.9+27R	4+24R	4.6+21R	4.6+19R	4.6+17R	5+16R
	VSC2 @ 12"	q	1330	1322	1316	1312	1309	1306	1304	1303	1301
		F	1.6+48R	2.2+38R	2.7+32R	3+27R	3.2+24R	3.4+21R	3.5+19R	3.7+17R	3.8+16R
	VSC2 @ 8"	q	1409	1416	1404	1410	1401	1406	1399	1404	1398
		F	0.8+48R	1.3+38R	1.9+32R	2.1+27R	2.4+24R	2.5+21R	2.7+19R	2.7+17R	2.9+16R
	VSC2 @ 6"	q	1444	1443	1442	1441	1440	1440	1440	1439	1439
		F	0.4+48R	1+38R	1.4+32R	1.7+27R	1.9+24R	2.1+21R	2.2+19R	2.3+17R	2.4+16R
	VSC2 @ 4"	q	1473	1473	1472	1472	1472	1472	1472	1471	1471
		F	0+48R	0.6+38R	1+32R	1.3+27R	1.5+24R	1.7+21R	1.8+19R	1.9+17R	2+16R

See footnotes on page 28.

Type PLB™ -36

- 36/7/4 Pneutek Fastener Pattern at Supports
SDK63 at Supports 0.155 to 0.250" thick
- Sidelaps Connected with PunchLok II Tool

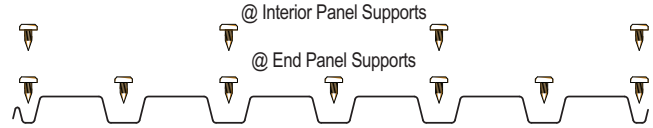

Allowable Diaphragm Shear Strength, q (plf) and Flexibility Factors, F ((in./lb)x10⁶)

DECK GAGE	SIDELAP ATTACHMENT	SPAN (ft.-in.)									
		4'-0"	5'-0"	6'-0"	7'-0"	8'-0"	9'-0"	10'-0"	11'-0"	12'-0"	
22	VSC2 @ 24"	q	653	672	576	601	535	560	510		
		F	13.8+26R	13.7+21R	16.2+16R	15.6+14R	17.5+11R	16.9+10R	18.5+8R		
	VSC2 @ 18"	q	802	791	685	693	700	635	646		
		F	11.1+28R	11.6+22R	13.6+17R	13.6+15R	13.6+13R	15+11R	14.8+10R		
	VSC2 @ 12"	q	928	895	872	855	842	832	823		
		F	9.4+29R	10.1+23R	10.7+19R	11+16R	11.3+14R	11.5+12R	11.7+11R		
	VSC2 @ 8"	q	1119	1128	1081	1094	1060	1073	1001		
		F	7.4+29R	7.7+24R	8.4+19R	8.4+17R	8.8+15R	8.8+13R	9.1+12R		
	VSC2 @ 6"	q	1249	1234	1223	1215	1209	1204	1001		
		F	6.3+30R	6.8+24R	7.1+20R	7.3+17R	7.5+15R	7.6+13R	7.8+12R		
	VSC2 @ 4"	q	1399	1392	1387	1383	1380	1236	1001		
		F	5.1+30R	5.5+24R	5.8+20R	6+17R	6.1+15R	6.2+13R	6.3+12R		
20	VSC2 @ 24"	q	825	859	741	780	697	734	670	703	652
		F	11.2+16R	10.9+13R	12.8+10R	12.2+9R	13.6+7R	13+6R	14.2+5R	13.6+5R	14.6+4R
	VSC2 @ 18"	q	1014	1009	882	898	910	830	847	861	803
		F	9+17R	9.2+14R	10.7+11R	10.6+9R	10.5+8R	11.5+7R	11.3+6R	11.2+6R	12+5R
	VSC2 @ 12"	q	1167	1135	1112	1096	1083	1073	1065	1058	912
		F	7.6+18R	8.1+14R	8.4+12R	8.6+10R	8.8+9R	8.9+8R	9+7R	9.1+6R	9.2+6R
	VSC2 @ 8"	q	1384	1398	1349	1365	1331	1346	1313	1085	912
		F	6.1+19R	6.2+15R	6.6+12R	6.6+11R	6.9+9R	6.9+8R	7.1+7R	7.1+7R	7.2+6R
	VSC2 @ 6"	q	1519	1506	1498	1491	1486	1482	1313	1085	912
		F	5.2+19R	5.5+15R	5.7+13R	5.9+11R	6+9R	6+8R	6.1+8R	6.2+7R	6.2+6R
	VSC2 @ 4"	q	1664	1658	1654	1651	1649	1621	1313	1085	912
		F	4.3+19R	4.6+15R	4.7+13R	4.9+11R	5+10R	5+8R	5.1+8R	5.1+7R	5.2+6R
18	VSC2 @ 24"	q	1142	1204	1050	1112	1002	1057	972	1021	951
		F	7.3+8R	6.8+7R	7.9+5R	7.4+5R	8.2+4R	7.8+3R	8.4+3R	8+3R	8.5+2R
	VSC2 @ 18"	q	1397	1401	1244	1271	1291	1189	1215	1235	1160
		F	5.8+9R	5.8+7R	6.6+6R	6.5+5R	6.4+4R	6.9+4R	6.8+3R	6.7+3R	7.1+3R
	VSC2 @ 12"	q	1588	1558	1536	1521	1509	1499	1492	1485	1394
		F	4.9+9R	5.1+7R	5.3+6R	5.4+5R	5.4+4R	5.5+4R	5.5+4R	5.6+3R	5.6+3R
	VSC2 @ 8"	q	1834	1853	1805	1824	1790	1807	1781	1659	1394
		F	4+9R	4.1+7R	4.3+6R	4.3+5R	4.4+5R	4.4+4R	4.5+4R	4.5+3R	4.5+3R
	VSC2 @ 6"	q	1972	1962	1956	1951	1947	1944	1941	1659	1394
		F	3.6+9R	3.7+7R	3.8+6R	3.8+5R	3.9+5R	3.9+4R	4+4R	4+3R	4+3R
	VSC2 @ 4"	q	2106	2103	2100	2098	2097	2095	2007	1659	1394
		F	3.1+9R	3.2+8R	3.3+6R	3.3+5R	3.4+5R	3.4+4R	3.4+4R	3.4+3R	3.5+3R
16	VSC2 @ 24"	q	1439	1525	1342	1423	1290	1362	1258	1321	1236
		F	6.2+4R	5.8+4R	6.6+3R	6.2+2R	6.9+2R	6.5+2R	7+1R	6.7+1R	7.1+1R
	VSC2 @ 18"	q	1747	1759	1578	1614	1641	1522	1555	1581	1493
		F	4.9+5R	4.9+4R	5.6+3R	5.4+3R	5.3+2R	5.8+2R	5.7+2R	5.6+2R	5.9+1R
	VSC2 @ 12"	q	1965	1936	1916	1901	1890	1881	1873	1867	1862
		F	4.2+5R	4.3+4R	4.4+3R	4.5+3R	4.5+2R	4.6+2R	4.6+2R	4.6+2R	4.6+2R
	VSC2 @ 8"	q	2227	2248	2202	2222	2189	2207	2180	2197	1941
		F	3.4+5R	3.4+4R	3.6+3R	3.6+3R	3.7+3R	3.6+2R	3.7+2R	3.7+2R	3.8+2R
	VSC2 @ 6"	q	2365	2357	2351	2347	2344	2341	2339	2310	1941
		F	3+5R	3.1+4R	3.2+4R	3.2+3R	3.2+3R	3.3+2R	3.3+2R	3.3+2R	3.3+2R
	VSC2 @ 4"	q	2492	2489	2487	2485	2484	2483	2482	2310	1941
		F	2.6+5R	2.7+4R	2.7+4R	2.8+3R	2.8+3R	2.8+2R	2.8+2R	2.8+2R	2.9+2R

See footnotes on page 28.

Type PLB™ -36

- 36/7 Pneutek Fastener Pattern at Supports
SDK63 at Supports 0.155 to 0.250" thick
- Sidelaps Connected with PunchLok II Tool



Allowable Diaphragm Shear Strength, q (plf) and Flexibility Factors, F ((in./lb)x10⁶)

DECK GAGE	SIDELAP ATTACHMENT	SPAN (ft-in.)									
		4'-0"	5'-0"	6'-0"	7'-0"	8'-0"	9'-0"	10'-0"	11'-0"	12'-0"	
22	VSC2 @ 24"	q	692	703	603	625	556	579	527		
		F	12.3+28R	12.6+22R	14.8+17R	14.5+15R	16.3+12R	15.9+11R	17.3+10R		
	VSC2 @ 18"	q	835	818	710	715	719	652	662		
		F	10.2+29R	10.8+23R	12.7+18R	12.8+16R	12.9+14R	14.2+12R	14.1+11R		
	VSC2 @ 12"	q	955	918	892	872	858	846	836		
		F	8.8+29R	9.6+23R	10.2+19R	10.6+16R	10.9+14R	11.1+13R	11.3+11R		
	VSC2 @ 8"	q	1138	1143	1094	1105	1071	1082	1001		
		F	7.1+30R	7.4+24R	8.1+20R	8.2+17R	8.6+15R	8.6+13R	8.9+12R		
	VSC2 @ 6"	q	1262	1244	1232	1223	1216	1211	1001		
		F	6.1+30R	6.6+24R	6.9+20R	7.2+17R	7.4+15R	7.5+13R	7.7+12R		
	VSC2 @ 4"	q	1406	1397	1391	1387	1384	1236	1001		
		F	5+30R	5.4+24R	5.7+20R	5.9+17R	6.1+15R	6.2+13R	6.3+12R		
20	VSC2 @ 24"	q	866	891	771	805	720	754	689	720	668
		F	10.2+17R	10.2+14R	11.9+11R	11.5+9R	12.8+8R	12.4+7R	13.5+6R	13+6R	13.9+5R
	VSC2 @ 18"	q	1048	1036	908	920	929	848	863	875	817
		F	8.4+18R	8.7+14R	10.1+11R	10.1+10R	10.1+9R	11.1+7R	10.9+7R	10.8+6R	11.6+5R
	VSC2 @ 12"	q	1194	1157	1132	1113	1098	1087	1078	1070	912
		F	7.2+18R	7.7+15R	8.1+12R	8.3+10R	8.5+9R	8.7+8R	8.8+7R	8.9+6R	9+6R
	VSC2 @ 8"	q	1400	1410	1362	1376	1341	1355	1313	1085	912
		F	5.9+19R	6+15R	6.5+12R	6.5+11R	6.8+9R	6.8+8R	7+7R	7+7R	7.1+6R
	VSC2 @ 6"	q	1530	1515	1505	1498	1492	1488	1313	1085	912
		F	5.1+19R	5.4+15R	5.6+13R	5.8+11R	5.9+9R	6+8R	6.1+8R	6.1+7R	6.2+6R
	VSC2 @ 4"	q	1668	1662	1657	1654	1652	1621	1313	1085	912
		F	4.2+19R	4.5+15R	4.7+13R	4.8+11R	4.9+10R	5+9R	5.1+8R	5.1+7R	5.1+6R
18	VSC2 @ 24"	q	1187	1238	1083	1138	1027	1079	993	1039	969
		F	6.8+8R	6.6+7R	7.5+5R	7.2+5R	7.9+4R	7.5+4R	8.2+3R	7.8+3R	8.3+3R
	VSC2 @ 18"	q	1431	1429	1271	1294	1310	1208	1232	1250	1175
		F	5.6+9R	5.6+7R	6.4+6R	6.3+5R	6.2+4R	6.8+4R	6.7+3R	6.6+3R	7+3R
	VSC2 @ 12"	q	1613	1579	1555	1537	1523	1512	1504	1496	1394
		F	4.8+9R	5+7R	5.2+6R	5.3+5R	5.3+4R	5.4+4R	5.4+4R	5.5+3R	5.5+3R
	VSC2 @ 8"	q	1847	1863	1815	1833	1798	1814	1787	1659	1394
		F	4+9R	4+7R	4.2+6R	4.2+5R	4.4+5R	4.3+4R	4.5+4R	4.4+3R	4.5+3R
	VSC2 @ 6"	q	1980	1969	1961	1956	1951	1948	1945	1659	1394
		F	3.5+9R	3.7+7R	3.8+6R	3.8+5R	3.9+5R	3.9+4R	3.9+4R	4+3R	4+3R
	VSC2 @ 4"	q	2110	2105	2102	2100	2098	2097	2007	1659	1394
		F	3+9R	3.2+8R	3.2+6R	3.3+5R	3.4+5R	3.4+4R	3.4+4R	3.4+3R	3.5+3R
16	VSC2 @ 24"	q	1487	1560	1377	1451	1317	1384	1280	1340	1255
		F	5.9+5R	5.6+4R	6.4+3R	6+3R	6.6+2R	6.3+2R	6.8+2R	6.5+2R	7+1R
	VSC2 @ 18"	q	1781	1786	1606	1638	1660	1542	1572	1596	1508
		F	4.7+5R	4.8+4R	5.4+3R	5.3+3R	5.2+2R	5.7+2R	5.6+2R	5.5+2R	5.8+2R
	VSC2 @ 12"	q	1988	1956	1933	1916	1904	1893	1885	1878	1872
		F	4.1+5R	4.2+4R	4.3+3R	4.4+3R	4.5+3R	4.5+2R	4.5+2R	4.6+2R	4.6+2R
	VSC2 @ 8"	q	2239	2257	2211	2229	2196	2213	2186	2201	1941
		F	3.4+5R	3.4+4R	3.6+3R	3.5+3R	3.6+3R	3.6+2R	3.7+2R	3.7+2R	3.7+2R
	VSC2 @ 6"	q	2371	2362	2356	2351	2348	2345	2342	2310	1941
		F	3+5R	3.1+4R	3.1+4R	3.2+3R	3.2+3R	3.2+2R	3.3+2R	3.3+2R	3.3+2R
	VSC2 @ 4"	q	2494	2491	2489	2487	2486	2484	2484	2310	1941
		F	2.6+5R	2.7+4R	2.7+4R	2.8+3R	2.8+3R	2.8+2R	2.8+2R	2.8+2R	2.9+2R

See footnotes on page 28.

Type PLB™ -36

- 36/9 Pneutek Fastener Pattern at Supports
- SDK63 at Supports 0.155 to 0.250" thick
- Sidelaps Connected with PunchLok II Tool

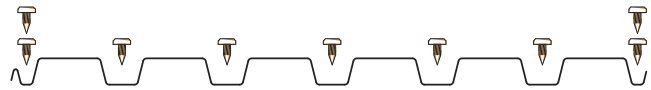

Allowable Diaphragm Shear Strength, q (plf) and Flexibility Factors, F ((in./lb)x10⁶)

DECK GAGE	SIDELAP ATTACHMENT	SPAN (ft.-in.)									
		4'-0"	5'-0"	6'-0"	7'-0"	8'-0"	9'-0"	10'-0"	11'-0"	12'-0"	
22	VSC2 @ 24"	q	889	867	743	748	665	678	616		
		F	10.4+28R	11+22R	13+17R	13.1+15R	14.6+12R	14.5+11R	15.8+9R		
	VSC2 @ 18"	q	1034	987	853	842	834	755	757		
		F	9+29R	9.8+23R	11.4+18R	11.7+15R	11.9+13R	13.1+11R	13.2+10R		
	VSC2 @ 12"	q	1162	1096	1049	1014	986	965	947		
		F	8+29R	8.8+23R	9.4+19R	9.9+16R	10.3+14R	10.6+12R	10.8+11R		
	VSC2 @ 8"	q	1369	1357	1284	1287	1237	1236	1001		
		F	6.6+30R	7+24R	7.7+20R	7.9+17R	8.3+15R	8.4+13R	8.7+12R		
	VSC2 @ 6"	q	*1523	*1486	*1460	*1440	*1425	1236	1001		
		F	5.8+30R	6.3+24R	6.7+20R	7+17R	7.2+15R	7.4+13R	7.5+12R		
	VSC2 @ 4"	q	*1721	*1700	*1686	*1675	*1564	1236	1001		
		F	4.8+30R	5.3+24R	5.6+20R	5.8+17R	6+15R	6.1+13R	6.2+12R		
20	VSC2 @ 24"	q	1092	1083	933	950	847	871	794	819	758
		F	8.9+17R	9.2+14R	10.6+11R	10.5+9R	11.7+8R	11.5+7R	12.5+6R	12.2+5R	13+5R
	VSC2 @ 18"	q	1281	1238	1077	1073	1070	972	980	987	912
		F	7.6+18R	8+14R	9.3+11R	9.4+10R	9.5+8R	10.4+7R	10.4+6R	10.3+6R	11+5R
	VSC2 @ 12"	q	1441	1374	1326	1290	1263	1241	1223	1085	912
		F	6.7+18R	7.2+14R	7.6+12R	7.9+10R	8.2+9R	8.3+8R	8.5+7R	8.6+6R	8.7+6R
	VSC2 @ 8"	q	1687	1683	1607	1615	1562	1575	1313	1085	912
		F	5.6+19R	5.8+15R	6.3+12R	6.3+11R	6.6+9R	6.6+8R	6.9+7R	6.8+7R	7+6R
	VSC2 @ 6"	q	*1857	*1825	*1801	*1784	*1771	1621	1313	1085	912
		F	4.9+19R	5.2+15R	5.5+13R	5.7+11R	5.8+9R	5.9+8R	6+8R	6+7R	6.1+6R
	VSC2 @ 4"	q	*2060	*2044	*2032	*2024	*2017	1621	1313	1085	912
		F	4.1+19R	4.4+15R	4.6+13R	4.8+11R	4.9+10R	4.9+8R	5+8R	5.1+7R	5.1+6R
18	VSC2 @ 24"	q	1467	1482	1288	1327	1191	1234	1130	1172	1089
		F	6.3+8R	6.2+7R	7+5R	6.8+5R	7.5+4R	7.2+3R	7.8+3R	7.5+3R	8+2R
	VSC2 @ 18"	q	1730	1695	1493	1500	1506	1378	1395	1410	1317
		F	5.2+9R	5.4+7R	6.1+6R	6.1+5R	6+4R	6.5+4R	6.5+3R	6.4+3R	6.8+3R
	VSC2 @ 12"	q	1941	1874	1825	1790	1762	1740	1721	1659	1394
		F	4.6+9R	4.8+7R	5+6R	5.1+5R	5.2+4R	5.3+4R	5.3+4R	5.4+3R	5.4+3R
	VSC2 @ 8"	q	*2239	*2246	2167	2183	2127	2145	2007	1659	1394
		F	3.9+9R	3.9+7R	4.2+6R	4.2+5R	4.3+5R	4.3+4R	4.4+4R	4.4+3R	4.5+3R
	VSC2 @ 6"	q	*2428	*2401	*2382	*2367	*2356	*2348	2007	1659	1394
		F	3.5+9R	3.6+7R	3.7+6R	3.8+5R	3.8+5R	3.9+4R	3.9+4R	3.9+3R	4+3R
	VSC2 @ 4"	q	*2632	*2620	*2611	*2605	*2600	*2478	2007	1659	1394
		F	3+9R	3.1+8R	3.2+6R	3.3+5R	3.3+5R	3.4+4R	3.4+4R	3.4+3R	3.5+3R
16	VSC2 @ 24"	q	1819	1857	1624	1684	1518	1579	1452	1510	1407
		F	5.4+5R	5.2+4R	6+3R	5.7+2R	6.3+2R	6.1+2R	6.5+2R	6.3+1R	6.7+1R
	VSC2 @ 18"	q	2146	2118	1882	1899	1912	1760	1786	1807	1696
		F	4.5+5R	4.6+4R	5.2+3R	5.1+3R	5.1+2R	5.5+2R	5.4+2R	5.3+2R	5.7+1R
	VSC2 @ 12"	q	2395	2329	2281	2245	2218	2195	2177	2162	1941
		F	3.9+5R	4.1+4R	4.2+3R	4.3+3R	4.4+2R	4.4+2R	4.5+2R	4.5+2R	4.5+2R
	VSC2 @ 8"	q	*2730	*2743	*2663	*2684	*2627	*2648	*2603	2310	1941
		F	3.3+5R	3.3+4R	3.5+3R	3.5+3R	3.6+3R	3.6+2R	3.7+2R	3.6+2R	3.7+2R
	VSC2 @ 6"	q	*2927	*2904	*2887	*2875	*2866	*2858	*2795	2310	1941
		F	3+5R	3.1+4R	3.1+4R	3.2+3R	3.2+3R	3.2+2R	3.2+2R	3.3+2R	3.3+2R
	VSC2 @ 4"	q	*3130	*3120	*3113	*3108	*3104	*3101	*2795	2310	1941
		F	2.6+5R	2.7+4R	2.7+4R	2.7+3R	2.8+3R	2.8+2R	2.8+2R	2.8+2R	2.8+2R

1. For diaphragm shear strengths in bold and marked with *, the fastening pattern shall be increased at the building perimeter, chords, collectors or other shear transfer elements to two fasteners per rib (i.e. 36/14 pattern) or shall be limited to 1400 plf, 1700 plf, 2200 plf, or 2500 plf for 22, 20, 18 or 16 gage steel deck, respectively. Bearing at supports shall allow for proper fastener spacing and end distance.
 2. See additional footnotes on page 28.

Type PLB™ -36

- 36/4 Pneutek Fastener Pattern at Supports
K64 at Supports 0.187 to 0.312" thick
- Sidelaps Connected with PunchLok II Tool



Allowable Diaphragm Shear Strength, q (plf) and Flexibility Factors, F ((in./lb)x10⁶)

DECK GAGE	SIDELAP ATTACHMENT	SPAN (ft-in.)									
		4'-0"	5'-0"	6'-0"	7'-0"	8'-0"	9'-0"	10'-0"	11'-0"	12'-0"	
22	VSC2 @ 24"	q	539	558	493	515	468	488	452		
		F	-0.6+269R	2.1+215R	6.6+178R	7.4+153R	10.4+133R	10.4+119R	12.7+106R		
	VSC2 @ 18"	q	635	633	569	578	583	542	551		
		F	-3.5+270R	-0.1+216R	3.9+179R	5.3+154R	6.3+135R	8.5+119R	8.9+107R		
	VSC2 @ 12"	q	704	690	680	672	667	662	658		
		F	-5.3+271R	-1.6+216R	0.9+180R	2.6+154R	4+135R	5+120R	5.8+108R		
	VSC2 @ 8"	q	788	793	775	781	769	774	764		
		F	-7.3+271R	-4.1+217R	-1.5+181R	0+155R	1.4+135R	2.2+120R	3.2+108R		
	VSC2 @ 6"	q	834	830	827	825	823	822	821		
		F	-8.5+271R	-5.1+217R	-2.8+181R	-1.1+155R	0.1+136R	1.1+121R	1.8+108R		
	VSC2 @ 4"	q	877	876	875	874	873	873	872		
		F	-9.8+272R	-6.4+217R	-4.1+181R	-2.5+155R	-1.3+136R	-0.3+121R	0.4+109R		
20	VSC2 @ 24"	q	714	741	658	688	628	656	608	634	595
		F	2.1+170R	3.6+136R	6.7+113R	6.9+97R	9.1+84R	8.9+75R	10.5+67R	10.2+61R	11.5+56R
	VSC2 @ 18"	q	838	837	758	769	778	725	737	747	708
		F	-0.3+171R	1.8+137R	4.6+114R	5.3+97R	5.9+85R	7.4+76R	7.6+68R	7.8+62R	8.9+57R
	VSC2 @ 12"	q	924	908	897	889	882	877	873	869	866
		F	-1.7+171R	0.6+137R	2.2+114R	3.3+98R	4.1+86R	4.8+76R	5.3+68R	5.7+62R	6.1+57R
	VSC2 @ 8"	q	1026	1032	1012	1020	1005	1012	1000	1007	912
		F	-3.3+172R	-1.3+137R	0.4+114R	1.3+98R	2.3+86R	2.7+76R	3.4+69R	3.7+62R	4.1+57R
	VSC2 @ 6"	q	1079	1075	1072	1070	1068	1067	1066	1065	912
		F	-4.2+172R	-2+137R	-0.5+115R	0.5+98R	1.3+86R	1.9+76R	2.4+69R	2.8+62R	3.1+57R
	VSC2 @ 4"	q	1129	1127	1126	1125	1125	1124	1124	1085	912
		F	-5.1+172R	-3+138R	-1.5+115R	-0.5+98R	0.3+86R	0.9+76R	1.3+69R	1.7+63R	2+57R
18	VSC2 @ 24"	q	1027	1069	958	1003	920	962	897	934	880
		F	2.8+83R	3.2+67R	4.9+55R	4.8+48R	5.9+41R	5.7+37R	6.6+33R	6.4+30R	7+28R
	VSC2 @ 18"	q	1195	1197	1095	1113	1126	1057	1074	1088	1036
		F	1.2+84R	2.2+67R	3.6+56R	3.9+48R	4.1+42R	4.9+37R	5+33R	5+30R	5.6+28R
	VSC2 @ 12"	q	1306	1289	1276	1267	1260	1255	1250	1246	1243
		F	0.4+84R	1.5+67R	2.2+56R	2.7+48R	3.1+42R	3.4+37R	3.7+34R	3.9+30R	4.1+28R
	VSC2 @ 8"	q	1431	1439	1417	1426	1409	1418	1405	1412	1394
		F	-0.5+84R	0.4+67R	1.2+56R	1.6+48R	2.1+42R	2.3+37R	2.7+34R	2.8+31R	3+28R
	VSC2 @ 6"	q	1493	1489	1486	1483	1482	1480	1479	1478	1394
		F	-1+84R	0+67R	0.7+56R	1.2+48R	1.6+42R	1.9+37R	2.1+34R	2.3+31R	2.5+28R
	VSC2 @ 4"	q	1548	1547	1546	1545	1544	1544	1543	1543	1394
		F	-1.5+84R	-0.5+67R	0.2+56R	0.7+48R	1.1+42R	1.4+37R	1.6+34R	1.8+31R	1.9+28R
16	VSC2 @ 24"	q	1312	1368	1235	1293	1193	1246	1167	1214	1148
		F	3.6+47R	3.7+38R	4.9+31R	4.8+27R	5.6+24R	5.3+21R	6+19R	5.7+17R	6.3+16R
	VSC2 @ 18"	q	1516	1521	1403	1426	1442	1361	1383	1400	1339
		F	2.3+48R	2.8+38R	3.8+32R	3.9+27R	4+24R	4.6+21R	4.6+19R	4.6+17R	5+16R
	VSC2 @ 12"	q	1645	1627	1614	1605	1598	1592	1587	1583	1580
		F	1.6+48R	2.2+38R	2.7+32R	3+27R	3.2+24R	3.4+21R	3.5+19R	3.7+17R	3.8+16R
	VSC2 @ 8"	q	1784	1794	1770	1780	1763	1772	1758	1767	1755
		F	0.8+48R	1.3+38R	1.9+32R	2.1+27R	2.4+24R	2.5+21R	2.7+19R	2.7+17R	2.9+16R
	VSC2 @ 6"	q	1851	1847	1844	1842	1840	1839	1838	1837	1836
		F	0.4+48R	1+38R	1.4+32R	1.7+27R	1.9+24R	2.1+21R	2.2+19R	2.3+17R	2.4+16R
	VSC2 @ 4"	q	1909	1907	1906	1906	1905	1905	1904	1904	1904
		F	0+48R	0.6+38R	1+32R	1.3+27R	1.5+24R	1.7+21R	1.8+19R	1.9+17R	2+16R

See footnotes on page 28.

Type PLB™ -36

- 36/7/4 Pneutek Fastener Pattern at Supports
K64 at Supports 0.187 to 0.312" thick
- Sidelaps Connected with PunchLok II Tool

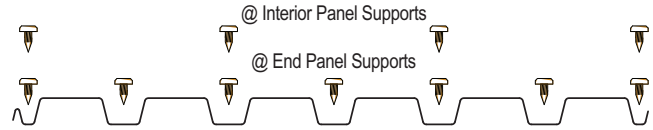

Allowable Diaphragm Shear Strength, q (plf) and Flexibility Factors, F ((in./lb)x10⁶)

DECK GAGE	SIDELAP ATTACHMENT	SPAN (ft.-in.)									
		4'-0"	5'-0"	6'-0"	7'-0"	8'-0"	9'-0"	10'-0"	11'-0"	12'-0"	
22	VSC2 @ 24"	q	654	673	576	602	536	561	511		
		F	13.8+26R	13.7+21R	16.2+16R	15.6+14R	17.5+11R	16.9+10R	18.5+8R		
	VSC2 @ 18"	q	803	792	686	694	701	636	647		
		F	11.1+28R	11.6+22R	13.6+17R	13.6+15R	13.6+13R	15+11R	14.8+10R		
	VSC2 @ 12"	q	929	896	873	856	843	833	824		
		F	9.4+29R	10.1+23R	10.7+19R	11+16R	11.3+14R	11.5+12R	11.7+11R		
	VSC2 @ 8"	q	1121	1131	1083	1096	1062	1075	1001		
		F	7.4+29R	7.7+24R	8.4+19R	8.4+17R	8.8+15R	8.8+13R	9.1+12R		
	VSC2 @ 6"	q	1252	1237	1226	1218	1212	1207	1001		
		F	6.3+30R	6.8+24R	7.1+20R	7.3+17R	7.5+15R	7.6+13R	7.8+12R		
	VSC2 @ 4"	q	1403	1396	1391	1387	1384	1236	1001		
		F	5.1+30R	5.5+24R	5.8+20R	6+17R	6.1+15R	6.2+13R	6.3+12R		
20	VSC2 @ 24"	q	873	903	775	813	725	760	693	726	672
		F	11.2+16R	10.9+13R	12.8+10R	12.2+9R	13.6+7R	13+6R	14.2+5R	13.6+5R	14.6+4R
	VSC2 @ 18"	q	1073	1062	923	937	947	861	878	891	829
		F	9+17R	9.2+14R	10.7+11R	10.6+9R	10.5+8R	11.5+7R	11.3+6R	11.2+6R	12+5R
	VSC2 @ 12"	q	1239	1199	1171	1151	1135	1123	1113	1085	912
		F	7.6+18R	8.1+14R	8.4+12R	8.6+10R	8.8+9R	8.9+8R	9+7R	9.1+6R	9.2+6R
	VSC2 @ 8"	q	1484	1498	1440	1457	1416	1433	1313	1085	912
		F	6.1+19R	6.2+15R	6.6+12R	6.6+11R	6.9+9R	6.9+8R	7.1+7R	7.1+7R	7.2+6R
	VSC2 @ 6"	q	1646	1628	1616	1607	1601	1595	1313	1085	912
		F	5.2+19R	5.5+15R	5.7+13R	5.9+11R	6+9R	6+8R	6.1+8R	6.2+7R	6.2+6R
	VSC2 @ 4"	q	1826	1818	1812	1808	1805	1621	1313	1085	912
		F	4.3+19R	4.6+15R	4.7+13R	4.9+11R	5+10R	5+8R	5.1+8R	5.1+7R	5.2+6R
18	VSC2 @ 24"	q	1271	1326	1145	1206	1079	1135	1038	1089	1010
		F	7.3+8R	6.8+7R	7.9+5R	7.4+5R	8.2+4R	7.8+3R	8.4+3R	8+3R	8.5+2R
	VSC2 @ 18"	q	1563	1556	1362	1387	1406	1284	1310	1332	1243
		F	5.8+9R	5.8+7R	6.6+6R	6.5+5R	6.4+4R	6.9+4R	6.8+3R	6.7+3R	7.1+3R
	VSC2 @ 12"	q	1796	1748	1715	1690	1671	1657	1644	1634	1394
		F	4.9+9R	5.1+7R	5.3+6R	5.4+5R	5.4+4R	5.5+4R	5.5+4R	5.6+3R	5.6+3R
	VSC2 @ 8"	q	2124	2146	2074	2099	2047	2070	2007	1659	1394
		F	4+9R	4.1+7R	4.3+6R	4.3+5R	4.4+5R	4.4+4R	4.5+4R	4.5+3R	4.5+3R
	VSC2 @ 6"	q	2328	2309	2296	2287	2280	2274	2007	1659	1394
		F	3.6+9R	3.7+7R	3.8+6R	3.8+5R	3.9+5R	3.9+4R	4+4R	4+3R	4+3R
	VSC2 @ 4"	q	2542	2534	2529	2525	2521	2478	2007	1659	1394
		F	3.1+9R	3.2+8R	3.3+6R	3.3+5R	3.4+5R	3.4+4R	3.4+4R	3.4+3R	3.5+3R
16	VSC2 @ 24"	q	1643	1724	1495	1580	1418	1494	1370	1438	1337
		F	6.2+4R	5.8+4R	6.6+3R	6.2+2R	6.9+2R	6.5+2R	7+1R	6.7+1R	7.1+1R
	VSC2 @ 18"	q	2017	2017	1776	1813	1839	1686	1722	1751	1639
		F	4.9+5R	4.9+4R	5.6+3R	5.4+3R	5.3+2R	5.8+2R	5.7+2R	5.6+2R	5.9+1R
	VSC2 @ 12"	q	2308	2255	2218	2191	2170	2154	2141	2130	1941
		F	4.2+5R	4.3+4R	4.4+3R	4.5+3R	4.5+2R	4.6+2R	4.6+2R	4.6+2R	4.6+2R
	VSC2 @ 8"	q	2699	2728	2647	2677	2619	2646	2602	2310	1941
		F	3.4+5R	3.4+4R	3.6+3R	3.6+3R	3.7+3R	3.6+2R	3.7+2R	3.7+2R	3.8+2R
	VSC2 @ 6"	q	2931	2912	2899	2890	2883	2877	2795	2310	1941
		F	3+5R	3.1+4R	3.2+4R	3.2+3R	3.2+3R	3.3+2R	3.3+2R	3.3+2R	3.3+2R
	VSC2 @ 4"	q	3165	3158	3152	3148	3145	3143	2795	2310	1941
		F	2.6+5R	2.7+4R	2.7+4R	2.8+3R	2.8+3R	2.8+2R	2.8+2R	2.8+2R	2.9+2R

See footnotes on page 28.

Type PLB™ -36

- 36/7 Pneutek Fastener Pattern at Supports
K64 at Supports 0.187 to 0.312" thick
- Sidelaps Connected with PunchLok II Tool



Allowable Diaphragm Shear Strength, q (plf) and Flexibility Factors, F ((in./lb)x10⁶)

DECK GAGE	SIDELAP ATTACHMENT	SPAN (ft-in.)									
		4'-0"	5'-0"	6'-0"	7'-0"	8'-0"	9'-0"	10'-0"	11'-0"	12'-0"	
22	VSC2 @ 24"	q	693	704	604	625	557	580	528		
		F	12.3+28R	12.6+22R	14.8+17R	14.5+15R	16.3+12R	15.9+11R	17.3+10R		
	VSC2 @ 18"	q	836	819	711	716	720	653	663		
		F	10.2+29R	10.8+23R	12.7+18R	12.8+16R	12.9+14R	14.2+12R	14.1+11R		
	VSC2 @ 12"	q	957	920	893	874	859	847	837		
		F	8.8+29R	9.6+23R	10.2+19R	10.6+16R	10.9+14R	11.1+13R	11.3+11R		
	VSC2 @ 8"	q	1140	1145	1097	1107	1073	1084	1001		
		F	7.1+30R	7.4+24R	8.1+20R	8.2+17R	8.6+15R	8.6+13R	8.9+12R		
	VSC2 @ 6"	q	1265	1247	1235	1226	1219	1214	1001		
		F	6.1+30R	6.6+24R	6.9+20R	7.2+17R	7.4+15R	7.5+13R	7.7+12R		
	VSC2 @ 4"	q	1410	1401	1395	1391	1387	1236	1001		
		F	5+30R	5.4+24R	5.7+20R	5.9+17R	6.1+15R	6.2+13R	6.3+12R		
20	VSC2 @ 24"	q	921	941	810	842	751	784	715	745	690
		F	10.2+17R	10.2+14R	11.9+11R	11.5+9R	12.8+8R	12.4+7R	13.5+6R	13+6R	13.9+5R
	VSC2 @ 18"	q	1113	1095	954	963	970	883	897	909	846
		F	8.4+18R	8.7+14R	10.1+11R	10.1+10R	10.1+9R	11.1+7R	10.9+7R	10.8+6R	11.6+5R
	VSC2 @ 12"	q	1272	1227	1195	1172	1154	1140	1129	1085	912
		F	7.2+18R	7.7+15R	8.1+12R	8.3+10R	8.5+9R	8.7+8R	8.8+7R	8.9+6R	9+6R
	VSC2 @ 8"	q	1506	1515	1456	1470	1429	1444	1313	1085	912
		F	5.9+19R	6+15R	6.5+12R	6.5+11R	6.8+9R	6.8+8R	7+7R	7+7R	7.1+6R
	VSC2 @ 6"	q	1660	1640	1627	1617	1609	1603	1313	1085	912
		F	5.1+19R	5.4+15R	5.6+13R	5.8+11R	5.9+9R	6+8R	6.1+8R	6.1+7R	6.2+6R
	VSC2 @ 4"	q	1832	1823	1817	1812	1809	1621	1313	1085	912
		F	4.2+19R	4.5+15R	4.7+13R	4.8+11R	4.9+10R	5+9R	5.1+8R	5.1+7R	5.1+6R
18	VSC2 @ 24"	q	1333	1374	1190	1243	1113	1165	1066	1114	1034
		F	6.8+8R	6.6+7R	7.5+5R	7.2+5R	7.9+4R	7.5+4R	8.2+3R	7.8+3R	8.3+3R
	VSC2 @ 18"	q	1613	1596	1401	1420	1435	1312	1335	1354	1265
		F	5.6+9R	5.6+7R	6.4+6R	6.3+5R	6.2+4R	6.8+4R	6.7+3R	6.6+3R	7+3R
	VSC2 @ 12"	q	1836	1782	1744	1716	1694	1677	1663	1652	1394
		F	4.8+9R	5+7R	5.2+6R	5.3+5R	5.3+4R	5.4+4R	5.4+4R	5.5+3R	5.5+3R
	VSC2 @ 8"	q	2149	2165	2092	2113	2062	2082	2007	1659	1394
		F	4+9R	4+7R	4.2+6R	4.2+5R	4.4+5R	4.3+4R	4.5+4R	4.4+3R	4.5+3R
	VSC2 @ 6"	q	2343	2322	2307	2297	2288	2282	2007	1659	1394
		F	3.5+9R	3.7+7R	3.8+6R	3.8+5R	3.9+5R	3.9+4R	3.9+4R	4+3R	4+3R
	VSC2 @ 4"	q	2549	2540	2533	2529	2525	2478	2007	1659	1394
		F	3+9R	3.2+8R	3.2+6R	3.3+5R	3.4+5R	3.4+4R	3.4+4R	3.4+3R	3.5+3R
16	VSC2 @ 24"	q	1716	1780	1548	1623	1458	1529	1403	1468	1365
		F	5.9+5R	5.6+4R	6.4+3R	6+3R	6.6+2R	6.3+2R	6.8+2R	6.5+2R	7+1R
	VSC2 @ 18"	q	2074	2062	1822	1851	1872	1718	1750	1776	1664
		F	4.7+5R	4.8+4R	5.4+3R	5.3+3R	5.2+2R	5.7+2R	5.6+2R	5.5+2R	5.8+2R
	VSC2 @ 12"	q	2351	2292	2250	2219	2196	2177	2161	2149	1941
		F	4.1+5R	4.2+4R	4.3+3R	4.4+3R	4.5+3R	4.5+2R	4.5+2R	4.6+2R	4.6+2R
	VSC2 @ 8"	q	2725	2747	2666	2692	2634	2659	2614	2310	1941
		F	3.4+5R	3.4+4R	3.6+3R	3.5+3R	3.6+3R	3.6+2R	3.7+2R	3.7+2R	3.7+2R
	VSC2 @ 6"	q	2946	2925	2910	2900	2891	2885	2795	2310	1941
		F	3+5R	3.1+4R	3.1+4R	3.2+3R	3.2+3R	3.2+2R	3.3+2R	3.3+2R	3.3+2R
	VSC2 @ 4"	q	3172	3163	3157	3152	3149	3146	2795	2310	1941
		F	2.6+5R	2.7+4R	2.7+4R	2.8+3R	2.8+3R	2.8+2R	2.8+2R	2.8+2R	2.9+2R

See footnotes on page 28.

Type PLB™ -36

- 36/9 Pneutek Fastener Pattern at Supports
K64 at Supports 0.187 to 0.312" thick
- Sidelaps Connected with PunchLok II Tool

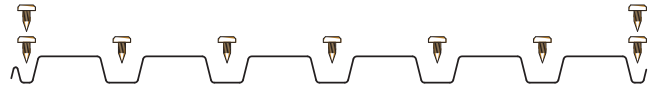

Allowable Diaphragm Shear Strength, q (plf) and Flexibility Factors, F ((in./lb)x10⁶)

DECK GAGE	SIDELAP ATTACHMENT	SPAN (ft.-in.)									
		4'-0"	5'-0"	6'-0"	7'-0"	8'-0"	9'-0"	10'-0"	11'-0"	12'-0"	
22	VSC2 @ 24"	q	891	869	744	749	666	679	617		
		F	10.4+28R	11+22R	13+17R	13.1+15R	14.6+12R	14.5+11R	15.8+9R		
	VSC2 @ 18"	q	1037	989	854	844	836	756	758		
		F	9+29R	9.8+23R	11.4+18R	11.7+15R	11.9+13R	13.1+11R	13.2+10R		
	VSC2 @ 12"	q	1165	1098	1050	1015	988	966	949		
		F	8+29R	8.8+23R	9.4+19R	9.9+16R	10.3+14R	10.6+12R	10.8+11R		
	VSC2 @ 8"	q	1372	1360	1286	1289	1239	1236	1001		
		F	6.6+30R	7+24R	7.7+20R	7.9+17R	8.3+15R	8.4+13R	8.7+12R		
	VSC2 @ 6"	q	*1526	*1489	*1463	*1443	*1428	1236	1001		
		F	5.8+30R	6.3+24R	6.7+20R	7+17R	7.2+15R	7.4+13R	7.5+12R		
	VSC2 @ 4"	q	*1725	*1705	*1690	*1679	*1564	1236	1001		
		F	4.8+30R	5.3+24R	5.6+20R	5.8+17R	6+15R	6.1+13R	6.2+12R		
20	VSC2 @ 24"	q	1173	1153	990	1002	891	912	830	853	788
		F	8.9+17R	9.2+14R	10.6+11R	10.5+9R	11.7+8R	11.5+7R	12.5+6R	12.2+5R	13+5R
	VSC2 @ 18"	q	1371	1315	1140	1130	1123	1017	1022	1027	912
		F	7.6+18R	8+14R	9.3+11R	9.4+10R	9.5+8R	10.4+7R	10.4+6R	10.3+6R	11+5R
	VSC2 @ 12"	q	1542	1460	1403	1360	1327	1300	1279	1085	912
		F	6.7+18R	7.2+14R	7.6+12R	7.9+10R	8.2+9R	8.3+8R	8.5+7R	8.6+6R	8.7+6R
	VSC2 @ 8"	q	1812	1802	1711	1718	1655	1621	1313	1085	912
		F	5.6+19R	5.8+15R	6.3+12R	6.3+11R	6.6+9R	6.6+8R	6.9+7R	6.8+7R	7+6R
	VSC2 @ 6"	q	*2008	*1965	*1935	*1912	1895	1621	1313	1085	912
		F	4.9+19R	5.2+15R	5.5+13R	5.7+11R	5.8+9R	5.9+8R	6+8R	6+7R	6.1+6R
	VSC2 @ 4"	q	*2251	*2229	*2213	*2201	*2052	1621	1313	1085	912
		F	4.1+19R	4.4+15R	4.6+13R	4.8+11R	4.9+10R	4.9+8R	5+8R	5+7R	5.1+6R
18	VSC2 @ 24"	q	1677	1667	1437	1465	1307	1345	1227	1266	1172
		F	6.3+8R	6.2+7R	7+5R	6.8+5R	7.5+4R	7.2+3R	7.8+3R	7.5+3R	8+2R
	VSC2 @ 18"	q	1969	1906	1660	1656	1652	1502	1515	1525	1394
		F	5.2+9R	5.4+7R	6.1+6R	6.1+5R	6+4R	6.5+4R	6.5+3R	6.4+3R	6.8+3R
	VSC2 @ 12"	q	2215	2114	2043	1990	1948	1915	1889	1659	1394
		F	4.6+9R	4.8+7R	5+6R	5.1+5R	5.2+4R	5.3+4R	5.3+4R	5.4+3R	5.4+3R
	VSC2 @ 8"	q	2590	2585	2471	2485	2406	2425	2007	1659	1394
		F	3.9+9R	3.9+7R	4.2+6R	4.2+5R	4.3+5R	4.3+4R	4.4+4R	4.4+3R	4.5+3R
	VSC2 @ 6"	q	*2847	*2799	*2765	*2740	*2720	2478	2007	1659	1394
		F	3.5+9R	3.6+7R	3.7+6R	3.8+5R	3.8+5R	3.9+4R	3.9+4R	3.9+3R	4+3R
	VSC2 @ 4"	q	*3151	*3127	*3110	*3098	*3088	2478	2007	1659	1394
		F	3+9R	3.1+8R	3.2+6R	3.3+5R	3.3+5R	3.4+4R	3.4+4R	3.4+3R	3.5+3R
16	VSC2 @ 24"	q	2139	2144	1855	1901	1701	1756	1605	1661	1540
		F	5.4+5R	5.2+4R	6+3R	5.7+2R	6.3+2R	6.1+2R	6.5+2R	6.3+1R	6.7+1R
	VSC2 @ 18"	q	2519	2453	2148	2150	2152	1962	1983	2001	1865
		F	4.5+5R	4.6+4R	5.2+3R	5.1+3R	5.1+2R	5.5+2R	5.4+2R	5.3+2R	5.7+1R
	VSC2 @ 12"	q	2831	2718	2637	2577	2530	2493	2462	2310	1941
		F	3.9+5R	4.1+4R	4.2+3R	4.3+3R	4.4+2R	4.4+2R	4.5+2R	4.5+2R	4.5+2R
	VSC2 @ 8"	q	*3291	*3294	3163	3185	3093	3118	2795	2310	1941
		F	3.3+5R	3.3+4R	3.5+3R	3.5+3R	3.6+3R	3.6+2R	3.7+2R	3.6+2R	3.7+2R
	VSC2 @ 6"	q	*3595	*3545	*3510	*3484	*3463	*3447	2795	2310	1941
		F	3+5R	3.1+4R	3.1+4R	3.2+3R	3.2+3R	3.2+2R	3.2+2R	3.3+2R	3.3+2R
	VSC2 @ 4"	q	*3938	*3915	*3898	*3886	*3877	*3451	2795	2310	1941
		F	2.6+5R	2.7+4R	2.7+4R	2.7+3R	2.8+3R	2.8+2R	2.8+2R	2.8+2R	2.8+2R

- For diaphragm shear strengths in bold and marked with *, the fastening pattern shall be increased at the building perimeter, chords, collectors or other shear transfer elements to two fasteners per rib (i.e. 36/14 pattern) or shall be limited to 1400 plf, 1900 plf, 2600 plf, or 3200 plf for 22, 20, 18 or 16 gage steel deck, respectively. Bearing at supports shall allow for proper fastener spacing and end distance.
- See footnotes on page 28.

Type PLB™ -36

- 36/4 Pneutek Fastener Pattern at Supports
K66 at Supports 0.281" and thicker
- Sidelaps Connected with PunchLok II Tool



Allowable Diaphragm Shear Strength, q (plf) and Flexibility Factors, F ((in./lb)x10⁶)

DECK GAGE	SIDELAP ATTACHMENT	SPAN (ft-in.)									
		4'-0"	5'-0"	6'-0"	7'-0"	8'-0"	9'-0"	10'-0"	11'-0"	12'-0"	
22	VSC2 @ 24"	q	559	576	507	529	479	500	462		
		F	-0.6+269R	2.1+215R	6.6+178R	7.4+153R	10.4+133R	10.4+119R	12.7+106R		
	VSC2 @ 18"	q	659	655	587	595	601	556	565		
		F	-3.5+270R	-0.1+216R	3.9+179R	5.3+154R	6.3+135R	8.5+119R	8.9+107R		
	VSC2 @ 12"	q	732	716	705	696	690	685	680		
		F	-5.3+271R	-1.6+216R	0.9+180R	2.6+154R	4+135R	5+120R	5.8+108R		
	VSC2 @ 8"	q	825	830	810	816	802	808	797		
		F	-7.3+271R	-4.1+217R	-1.5+181R	0+155R	1.4+135R	2.2+120R	3.2+108R		
	VSC2 @ 6"	q	876	871	868	865	863	861	860		
		F	-8.5+271R	-5.1+217R	-2.8+181R	-1.1+155R	0.1+136R	1.1+121R	1.8+108R		
	VSC2 @ 4"	q	926	924	922	921	921	920	920		
		F	-9.8+272R	-6.4+217R	-4.1+181R	-2.5+155R	-1.3+136R	-0.3+121R	0.4+109R		
20	VSC2 @ 24"	q	722	749	664	694	633	661	613	639	599
		F	2.1+170R	3.6+136R	6.7+113R	6.9+97R	9.1+84R	8.9+75R	10.5+67R	10.2+61R	11.5+56R
	VSC2 @ 18"	q	848	846	765	777	785	732	744	754	713
		F	-0.3+171R	1.8+137R	4.6+114R	5.3+97R	5.9+85R	7.4+76R	7.6+68R	7.8+62R	8.9+57R
	VSC2 @ 12"	q	936	919	908	899	892	887	882	879	876
		F	-1.7+171R	0.6+137R	2.2+114R	3.3+98R	4.1+86R	4.8+76R	5.3+68R	5.7+62R	6.1+57R
	VSC2 @ 8"	q	1041	1048	1027	1034	1019	1026	1014	1021	912
		F	-3.3+172R	-1.3+137R	0.4+114R	1.3+98R	2.3+86R	2.7+76R	3.4+69R	3.7+62R	4.1+57R
	VSC2 @ 6"	q	1097	1092	1089	1087	1085	1083	1082	1081	912
		F	-4.2+172R	-2+137R	-0.5+115R	0.5+98R	1.3+86R	1.9+76R	2.4+69R	2.8+62R	3.1+57R
	VSC2 @ 4"	q	1149	1147	1146	1145	1144	1144	1143	1085	912
		F	-5.1+172R	-3+138R	-1.5+115R	-0.5+98R	0.3+86R	0.9+76R	1.3+69R	1.7+63R	2+57R
18	VSC2 @ 24"	q	1051	1094	978	1023	937	979	912	950	894
		F	2.8+83R	3.2+67R	4.9+55R	4.8+48R	5.9+41R	5.7+37R	6.6+33R	6.4+30R	7+28R
	VSC2 @ 18"	q	1227	1228	1120	1138	1151	1078	1096	1110	1056
		F	1.2+84R	2.2+67R	3.6+56R	3.9+48R	4.1+42R	4.9+37R	5+33R	5+30R	5.6+28R
	VSC2 @ 12"	q	1344	1325	1311	1301	1293	1287	1282	1278	1274
		F	0.4+84R	1.5+67R	2.2+56R	2.7+48R	3.1+42R	3.4+37R	3.7+34R	3.9+30R	4.1+28R
	VSC2 @ 8"	q	1478	1487	1463	1472	1454	1463	1449	1457	1394
		F	-0.5+84R	0.4+67R	1.2+56R	1.6+48R	2.1+42R	2.3+37R	2.7+34R	2.8+31R	3+28R
	VSC2 @ 6"	q	1546	1541	1538	1535	1533	1532	1531	1530	1394
		F	-1+84R	0+67R	0.7+56R	1.2+48R	1.6+42R	1.9+37R	2.1+34R	2.3+31R	2.5+28R
	VSC2 @ 4"	q	1607	1605	1604	1603	1603	1602	1602	1601	1394
		F	-1.5+84R	-0.5+67R	0.2+56R	0.7+48R	1.1+42R	1.4+37R	1.6+34R	1.8+31R	1.9+28R
16	VSC2 @ 24"	q	1393	1451	1301	1362	1250	1306	1218	1269	1196
		F	3.6+47R	3.7+38R	4.9+31R	4.8+27R	5.6+24R	5.3+21R	6+19R	5.7+17R	6.3+16R
	VSC2 @ 18"	q	1622	1625	1487	1511	1528	1435	1459	1478	1407
		F	2.3+48R	2.8+38R	3.8+32R	3.9+27R	4+24R	4.6+21R	4.6+19R	4.6+17R	5+16R
	VSC2 @ 12"	q	1772	1748	1732	1720	1710	1702	1696	1691	1687
		F	1.6+48R	2.2+38R	2.7+32R	3+27R	3.2+24R	3.4+21R	3.5+19R	3.7+17R	3.8+16R
	VSC2 @ 8"	q	1940	1952	1921	1933	1911	1922	1905	1915	1901
		F	0.8+48R	1.3+38R	1.9+32R	2.1+27R	2.4+24R	2.5+21R	2.7+19R	2.7+17R	2.9+16R
	VSC2 @ 6"	q	2024	2018	2014	2011	2009	2007	2005	2004	1941
		F	0.4+48R	1+38R	1.4+32R	1.7+27R	1.9+24R	2.1+21R	2.2+19R	2.3+17R	2.4+16R
	VSC2 @ 4"	q	2098	2096	2095	2093	2093	2092	2092	2091	1941
		F	0+48R	0.6+38R	1+32R	1.3+27R	1.5+24R	1.7+21R	1.8+19R	1.9+17R	2+16R

See footnotes on page 28.

Type PLB™ -36

- 36/7/4 Pneutek Fastener Pattern at Supports
K66 at Supports 0.281" and thicker
- Sidelaps Connected with PunchLok II Tool

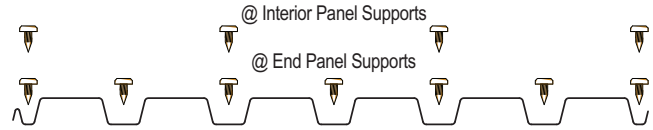

Allowable Diaphragm Shear Strength, q (plf) and Flexibility Factors, F ((in./lb)x10⁶)

DECK GAGE	SIDELAP ATTACHMENT	SPAN (ft.-in.)									
		4'-0"	5'-0"	6'-0"	7'-0"	8'-0"	9'-0"	10'-0"	11'-0"	12'-0"	
22	VSC2 @ 24"	q	675	691	591	615	547	571	520		
		F	13.8+26R	13.7+21R	16.2+16R	15.6+14R	17.5+11R	16.9+10R	18.5+8R		
	VSC2 @ 18"	q	827	813	702	710	715	648	659		
		F	11.1+28R	11.6+22R	13.6+17R	13.6+15R	13.6+13R	15+11R	14.8+10R		
	VSC2 @ 12"	q	958	921	895	876	862	851	841		
		F	9.4+29R	10.1+23R	10.7+19R	11+16R	11.3+14R	11.5+12R	11.7+11R		
	VSC2 @ 8"	q	1160	1169	1116	1129	1093	1106	1001		
		F	7.4+29R	7.7+24R	8.4+19R	8.4+17R	8.8+15R	8.8+13R	9.1+12R		
	VSC2 @ 6"	q	1301	1283	1271	1262	1255	1236	1001		
		F	6.3+30R	6.8+24R	7.1+20R	7.3+17R	7.5+15R	7.6+13R	7.8+12R		
	VSC2 @ 4"	q	1469	1460	1454	1449	1446	1236	1001		
		F	5.1+30R	5.5+24R	5.8+20R	6+17R	6.1+15R	6.2+13R	6.3+12R		
20	VSC2 @ 24"	q	881	910	781	818	729	765	697	730	675
		F	11.2+16R	10.9+13R	12.8+10R	12.2+9R	13.6+7R	13+6R	14.2+5R	13.6+5R	14.6+4R
	VSC2 @ 18"	q	1083	1071	930	944	954	867	883	896	834
		F	9+17R	9.2+14R	10.7+11R	10.6+9R	10.5+8R	11.5+7R	11.3+6R	11.2+6R	12+5R
	VSC2 @ 12"	q	1251	1210	1181	1160	1144	1131	1121	1085	912
		F	7.6+18R	8.1+14R	8.4+12R	8.6+10R	8.8+9R	8.9+8R	9+7R	9.1+6R	9.2+6R
	VSC2 @ 8"	q	1501	1515	1455	1472	1430	1447	1313	1085	912
		F	6.1+19R	6.2+15R	6.6+12R	6.6+11R	6.9+9R	6.9+8R	7.1+7R	7.1+7R	7.2+6R
	VSC2 @ 6"	q	1667	1649	1636	1627	1620	1614	1313	1085	912
		F	5.2+19R	5.5+15R	5.7+13R	5.9+11R	6+9R	6+8R	6.1+8R	6.2+7R	6.2+6R
	VSC2 @ 4"	q	1853	1845	1839	1835	1831	1621	1313	1085	912
		F	4.3+19R	4.6+15R	4.7+13R	4.9+11R	5+10R	5+8R	5.1+8R	5.1+7R	5.2+6R
18	VSC2 @ 24"	q	1296	1349	1163	1223	1093	1150	1050	1101	1021
		F	7.3+8R	6.8+7R	7.9+5R	7.4+5R	8.2+4R	7.8+3R	8.4+3R	8+3R	8.5+2R
	VSC2 @ 18"	q	1594	1585	1384	1409	1427	1301	1327	1349	1258
		F	5.8+9R	5.8+7R	6.6+6R	6.5+5R	6.4+4R	6.9+4R	6.8+3R	6.7+3R	7.1+3R
	VSC2 @ 12"	q	1835	1783	1747	1721	1700	1684	1671	1659	1394
		F	4.9+9R	5.1+7R	5.3+6R	5.4+5R	5.4+4R	5.5+4R	5.5+4R	5.6+3R	5.6+3R
	VSC2 @ 8"	q	2179	2201	2124	2149	2094	2118	2007	1659	1394
		F	4+9R	4.1+7R	4.3+6R	4.3+5R	4.4+5R	4.4+4R	4.5+4R	4.5+3R	4.5+3R
	VSC2 @ 6"	q	2396	2375	2361	2350	2342	2335	2007	1659	1394
		F	3.6+9R	3.7+7R	3.8+6R	3.8+5R	3.9+5R	3.9+4R	4+4R	4+3R	4+3R
	VSC2 @ 4"	q	2628	2619	2613	2608	2604	2478	2007	1659	1394
		F	3.1+9R	3.2+8R	3.3+6R	3.3+5R	3.4+5R	3.4+4R	3.4+4R	3.4+3R	3.5+3R
16	VSC2 @ 24"	q	1726	1802	1556	1639	1466	1543	1411	1480	1374
		F	6.2+4R	5.8+4R	6.6+3R	6.2+2R	6.9+2R	6.5+2R	7+1R	6.7+1R	7.1+1R
	VSC2 @ 18"	q	2122	2114	1851	1885	1911	1745	1781	1810	1690
		F	4.9+5R	4.9+4R	5.6+3R	5.4+3R	5.3+2R	5.8+2R	5.7+2R	5.6+2R	5.9+1R
	VSC2 @ 12"	q	2439	2374	2329	2296	2271	2251	2234	2221	1941
		F	4.2+5R	4.3+4R	4.4+3R	4.5+3R	4.5+2R	4.6+2R	4.6+2R	4.6+2R	4.6+2R
	VSC2 @ 8"	q	2883	2913	2816	2849	2780	2811	2757	2310	1941
		F	3.4+5R	3.4+4R	3.6+3R	3.6+3R	3.7+3R	3.6+2R	3.7+2R	3.7+2R	3.8+2R
	VSC2 @ 6"	q	3157	3133	3115	3103	3093	3085	2795	2310	1941
		F	3+5R	3.1+4R	3.2+4R	3.2+3R	3.2+3R	3.3+2R	3.3+2R	3.3+2R	3.3+2R
	VSC2 @ 4"	q	3447	3436	3428	3423	3419	3416	2795	2310	1941
		F	2.6+5R	2.7+4R	2.7+4R	2.8+3R	2.8+3R	2.8+2R	2.8+2R	2.8+2R	2.9+2R

See footnotes on page 28.

Type PLB™ -36

- 36/7 Pneutek Fastener Pattern at Supports
K66 at Supports 0.281" and thicker
- Sidelaps Connected with PunchLok II Tool



Allowable Diaphragm Shear Strength, q (plf) and Flexibility Factors, F ((in./lb)x10⁶)

DECK GAGE	SIDELAP ATTACHMENT	SPAN (ft-in.)									
		4'-0"	5'-0"	6'-0"	7'-0"	8'-0"	9'-0"	10'-0"	11'-0"	12'-0"	
22	VSC2 @ 24"	q	716	724	620	641	570	592	539		
		F	12.3+28R	12.6+22R	14.8+17R	14.5+15R	16.3+12R	15.9+11R	17.3+10R		
	VSC2 @ 18"	q	863	842	729	733	736	667	676		
		F	10.2+29R	10.8+23R	12.7+18R	12.8+16R	12.9+14R	14.2+12R	14.1+11R		
	VSC2 @ 12"	q	988	947	918	896	880	866	856		
		F	8.8+29R	9.6+23R	10.2+19R	10.6+16R	10.9+14R	11.1+13R	11.3+11R		
	VSC2 @ 8"	q	1182	1186	1132	1143	1105	1117	1001		
		F	7.1+30R	7.4+24R	8.1+20R	8.2+17R	8.6+15R	8.6+13R	8.9+12R		
	VSC2 @ 6"	q	1316	1296	1282	1271	1263	1236	1001		
		F	6.1+30R	6.6+24R	6.9+20R	7.2+17R	7.4+15R	7.5+13R	7.7+12R		
	VSC2 @ 4"	q	1477	1467	1459	1454	1450	1236	1001		
		F	5+30R	5.4+24R	5.7+20R	5.9+17R	6.1+15R	6.2+13R	6.3+12R		
20	VSC2 @ 24"	q	930	949	817	848	757	789	719	750	694
		F	10.2+17R	10.2+14R	11.9+11R	11.5+9R	12.8+8R	12.4+7R	13.5+6R	13+6R	13.9+5R
	VSC2 @ 18"	q	1124	1105	962	971	977	889	903	914	851
		F	8.4+18R	8.7+14R	10.1+11R	10.1+10R	10.1+9R	11.1+7R	10.9+7R	10.8+6R	11.6+5R
	VSC2 @ 12"	q	1285	1239	1206	1182	1163	1149	1137	1085	912
		F	7.2+18R	7.7+15R	8.1+12R	8.3+10R	8.5+9R	8.7+8R	8.8+7R	8.9+6R	9+6R
	VSC2 @ 8"	q	1524	1532	1471	1486	1443	1458	1313	1085	912
		F	5.9+19R	6+15R	6.5+12R	6.5+11R	6.8+9R	6.8+8R	7+7R	7+7R	7.1+6R
	VSC2 @ 6"	q	1682	1661	1647	1636	1628	1621	1313	1085	912
		F	5.1+19R	5.4+15R	5.6+13R	5.8+11R	5.9+9R	6+8R	6.1+8R	6.1+7R	6.2+6R
	VSC2 @ 4"	q	1860	1851	1844	1839	1835	1621	1313	1085	912
		F	4.2+19R	4.5+15R	4.7+13R	4.8+11R	4.9+10R	5+9R	5.1+8R	5.1+7R	5.1+6R
18	VSC2 @ 24"	q	1361	1400	1210	1263	1130	1181	1080	1128	1046
		F	6.8+8R	6.6+7R	7.5+5R	7.2+5R	7.9+4R	7.5+4R	8.2+3R	7.8+3R	8.3+3R
	VSC2 @ 18"	q	1647	1628	1426	1444	1457	1330	1353	1372	1281
		F	5.6+9R	5.6+7R	6.4+6R	6.3+5R	6.2+4R	6.8+4R	6.7+3R	6.6+3R	7+3R
	VSC2 @ 12"	q	1878	1819	1779	1748	1725	1707	1692	1659	1394
		F	4.8+9R	5+7R	5.2+6R	5.3+5R	5.3+4R	5.4+4R	5.4+4R	5.5+3R	5.5+3R
	VSC2 @ 8"	q	2206	2222	2144	2165	2110	2131	2007	1659	1394
		F	4+9R	4+7R	4.2+6R	4.2+5R	4.4+5R	4.3+4R	4.5+4R	4.4+3R	4.5+3R
	VSC2 @ 6"	q	2413	2389	2373	2361	2352	2344	2007	1659	1394
		F	3.5+9R	3.7+7R	3.8+6R	3.8+5R	3.9+5R	3.9+4R	3.9+4R	4+3R	4+3R
	VSC2 @ 4"	q	2636	2625	2618	2613	2609	2478	2007	1659	1394
		F	3+9R	3.2+8R	3.2+6R	3.3+5R	3.4+5R	3.4+4R	3.4+4R	3.4+3R	3.5+3R
16	VSC2 @ 24"	q	1809	1867	1616	1689	1513	1584	1449	1514	1406
		F	5.9+5R	5.6+4R	6.4+3R	6+3R	6.6+2R	6.3+2R	6.8+2R	6.5+2R	7+1R
	VSC2 @ 18"	q	2190	2168	1904	1930	1949	1783	1814	1840	1719
		F	4.7+5R	4.8+4R	5.4+3R	5.3+3R	5.2+2R	5.7+2R	5.6+2R	5.5+2R	5.8+2R
	VSC2 @ 12"	q	2492	2420	2369	2331	2302	2279	2260	2244	1941
		F	4.1+5R	4.2+4R	4.3+3R	4.4+3R	4.5+3R	4.5+2R	4.5+2R	4.6+2R	4.6+2R
	VSC2 @ 8"	q	2916	2938	2840	2869	2799	2827	2773	2310	1941
		F	3.4+5R	3.4+4R	3.6+3R	3.5+3R	3.6+3R	3.6+2R	3.7+2R	3.7+2R	3.7+2R
	VSC2 @ 6"	q	3178	3150	3130	3116	3105	3096	2795	2310	1941
		F	3+5R	3.1+4R	3.1+4R	3.2+3R	3.2+3R	3.2+2R	3.3+2R	3.3+2R	3.3+2R
	VSC2 @ 4"	q	3456	3443	3435	3429	3424	3420	2795	2310	1941
		F	2.6+5R	2.7+4R	2.7+4R	2.8+3R	2.8+3R	2.8+2R	2.8+2R	2.8+2R	2.9+2R

See footnotes on page 28.

Type PLB™ -36

- 36/9 Pneutek Fastener Pattern at Supports
K66 at Supports 0.281" and thicker
- Sidelaps Connected with PunchLok II Tool

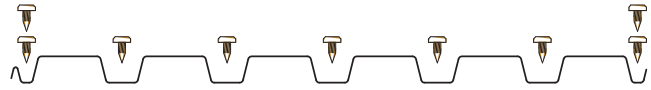

Allowable Diaphragm Shear Strength, q (plf) and Flexibility Factors, F ((in./lb)x10⁶)

DECK GAGE	SIDELAP ATTACHMENT	SPAN (ft.-in.)									
		4'-0"	5'-0"	6'-0"	7'-0"	8'-0"	9'-0"	10'-0"	11'-0"	12'-0"	
22	VSC2 @ 24"	q	926	899	769	771	685	696	630		
		F	10.4+28R	11+22R	13+17R	13.1+15R	14.6+12R	14.5+11R	15.8+9R		
	VSC2 @ 18"	q	1075	1021	880	867	857	774	775		
		F	9+29R	9.8+23R	11.4+18R	11.7+15R	11.9+13R	13.1+11R	13.2+10R		
	VSC2 @ 12"	q	1206	1133	1081	1043	1013	989	970		
		F	8+29R	8.8+23R	9.4+19R	9.9+16R	10.3+14R	10.6+12R	10.8+11R		
	VSC2 @ 8"	q	1423	1406	1327	1328	1274	1236	1001		
		F	6.6+30R	7+24R	7.7+20R	7.9+17R	8.3+15R	8.4+13R	8.7+12R		
	VSC2 @ 6"	q	*1587	*1544	*1514	1492	1474	1236	1001		
		F	5.8+30R	6.3+24R	6.7+20R	7+17R	7.2+15R	7.4+13R	7.5+12R		
	VSC2 @ 4"	q	*1803	*1779	*1762	*1749	*1564	1236	1001		
		F	4.8+30R	5.3+24R	5.6+20R	5.8+17R	6+15R	6.1+13R	6.2+12R		
20	VSC2 @ 24"	q	1187	1165	1000	1010	899	919	836	859	794
		F	8.9+17R	9.2+14R	10.6+11R	10.5+9R	11.7+8R	11.5+7R	12.5+6R	12.2+5R	13+5R
	VSC2 @ 18"	q	1386	1329	1150	1140	1131	1025	1030	1034	912
		F	7.6+18R	8+14R	9.3+11R	9.4+10R	9.5+8R	10.4+7R	10.4+6R	10.3+6R	11+5R
	VSC2 @ 12"	q	1559	1475	1416	1371	1337	1310	1288	1085	912
		F	6.7+18R	7.2+14R	7.6+12R	7.9+10R	8.2+9R	8.3+8R	8.5+7R	8.6+6R	8.7+6R
	VSC2 @ 8"	q	1834	1821	1729	1735	1671	1621	1313	1085	912
		F	5.6+19R	5.8+15R	6.3+12R	6.3+11R	6.6+9R	6.6+8R	6.9+7R	6.8+7R	7+6R
	VSC2 @ 6"	q	*2033	*1989	*1957	*1933	*1915	1621	1313	1085	912
		F	4.9+19R	5.2+15R	5.5+13R	5.7+11R	5.8+9R	5.9+8R	6+8R	6+7R	6.1+6R
	VSC2 @ 4"	q	*2284	*2260	*2243	*2231	*2052	1621	1313	1085	912
		F	4.1+19R	4.4+15R	4.6+13R	4.8+11R	4.9+10R	4.9+8R	5+8R	5.1+7R	5.1+6R
18	VSC2 @ 24"	q	1719	1704	1466	1492	1330	1367	1246	1284	1188
		F	6.3+8R	6.2+7R	7+5R	6.8+5R	7.5+4R	7.2+3R	7.8+3R	7.5+3R	8+2R
	VSC2 @ 18"	q	2016	1947	1693	1686	1680	1526	1537	1547	1394
		F	5.2+9R	5.4+7R	6.1+6R	6.1+5R	6+4R	6.5+4R	6.5+3R	6.4+3R	6.8+3R
	VSC2 @ 12"	q	2268	2161	2084	2027	1983	1948	1919	1659	1394
		F	4.6+9R	4.8+7R	5+6R	5.1+5R	5.2+4R	5.3+4R	5.3+4R	5.4+3R	5.4+3R
	VSC2 @ 8"	q	2657	2649	2528	2541	2456	2476	2007	1659	1394
		F	3.9+9R	3.9+7R	4.2+6R	4.2+5R	4.3+5R	4.3+4R	4.4+4R	4.4+3R	4.5+3R
	VSC2 @ 6"	q	*2927	*2875	*2838	*2810	*2788	2478	2007	1659	1394
		F	3.5+9R	3.6+7R	3.7+6R	3.8+5R	3.8+5R	3.9+4R	3.9+4R	3.9+3R	4+3R
	VSC2 @ 4"	q	*3252	*3226	*3207	*3193	*3136	2478	2007	1659	1394
		F	3+9R	3.1+8R	3.2+6R	3.3+5R	3.3+5R	3.4+4R	3.4+4R	3.4+3R	3.5+3R
16	VSC2 @ 24"	q	2276	2263	1951	1990	1776	1828	1667	1720	1593
		F	5.4+5R	5.2+4R	6+3R	5.7+2R	6.3+2R	6.1+2R	6.5+2R	6.3+1R	6.7+1R
	VSC2 @ 18"	q	2673	2588	2255	2249	2245	2041	2059	2073	1928
		F	4.5+5R	4.6+4R	5.2+3R	5.1+3R	5.1+2R	5.5+2R	5.4+2R	5.3+2R	5.7+1R
	VSC2 @ 12"	q	3007	2871	2775	2703	2647	2603	2566	2310	1941
		F	3.9+5R	4.1+4R	4.2+3R	4.3+3R	4.4+2R	4.4+2R	4.5+2R	4.5+2R	4.5+2R
	VSC2 @ 8"	q	*3515	*3509	3355	3374	3267	3293	2795	2310	1941
		F	3.3+5R	3.3+4R	3.5+3R	3.5+3R	3.6+3R	3.6+2R	3.7+2R	3.6+2R	3.7+2R
	VSC2 @ 6"	q	*3862	*3798	*3753	*3719	*3692	3451	2795	2310	1941
		F	3+5R	3.1+4R	3.1+4R	3.2+3R	3.2+3R	3.2+2R	3.2+2R	3.3+2R	3.3+2R
	VSC2 @ 4"	q	*4273	*4241	*4218	*4202	*4189	3451	2795	2310	1941
		F	2.6+5R	2.7+4R	2.7+4R	2.7+3R	2.8+3R	2.8+2R	2.8+2R	2.8+2R	2.8+2R

- For diaphragm shear strengths in bold and marked with *, the fastening pattern shall be increased at the building perimeter, chords, collectors or other shear transfer elements to two fasteners per rib (i.e. 36/14 pattern) or shall be limited to 1500 plf, 1900 plf, 2700 plf, or 3500 plf for 22, 20, 18 or 16 gage steel deck, respectively. Bearing at supports shall allow for proper end distance and fastener spacing.
- See footnotes on page 28.

Type PLB™ -36

- 36/4 Screw Pattern at Supports
#12 or #14 SDI Recognized Screws
to Supports 0.0385" and thicker
- Sidelaps Connected with PunchLok II Tool



Allowable Diaphragm Shear Strength, q (plf) and Flexibility Factors, F ((in./lb)x10⁶)

DECK GAGE	SIDELAP ATTACHMENT	SPAN (ft-in.)									
		2'-0"	3'-0"	4'-0"	5'-0"	6'-0"	7'-0"	8'-0"	9'-0"	10'-0"	
22	VSC2 @ 24"	q	535	548	476	495	444	464	426	445	415
		F	-24.1+542R	-12.1+360R	-4.5+269R	-0.9+215R	3+178R	4.5+153R	7.1+133R	7.8+118R	9.8+106R
	VSC2 @ 18"	q	632	548	555	555	508	516	522	489	498
		F	-25.2+542R	-12.1+360R	-5.9+270R	-2.2+216R	1.5+179R	3.2+153R	4.5+134R	6.5+119R	7.2+107R
	VSC2 @ 12"	q	632	616	606	598	592	588	585	582	580
		F	-25.2+542R	-13.2+361R	-6.9+270R	-3.1+216R	-0.5+180R	1.4+154R	2.8+135R	4+120R	4.9+108R
	VSC2 @ 8"	q	678	681	665	669	658	663	655	659	653
		F	-26+543R	-14.5+361R	-8.2+271R	-4.8+217R	-2.2+180R	-0.6+155R	0.9+135R	1.8+120R	2.7+108R
	VSC2 @ 6"	q	701	697	694	692	691	690	689	688	688
		F	-26.5+543R	-14.9+362R	-9.1+271R	-5.5+217R	-3.2+181R	-1.5+155R	-0.2+135R	0.8+120R	1.6+108R
	VSC2 @ 4"	q	723	722	721	720	719	719	719	719	718
		F	-27.1+543R	-15.7+362R	-10+271R	-6.6+217R	-4.3+181R	-2.7+155R	-1.4+136R	-0.5+121R	0.3+109R
20	VSC2 @ 24"	q	668	689	606	632	572	599	554	578	542
		F	-13.4+342R	-5.7+228R	-0.6+170R	1.6+136R	4.3+113R	5.1+96R	7+84R	7.3+75R	8.7+67R
	VSC2 @ 18"	q	781	689	699	702	648	659	667	630	640
		F	-14.4+343R	-5.7+228R	-1.9+171R	0.5+136R	3+113R	4+97R	4.8+85R	6.2+75R	6.6+68R
	VSC2 @ 12"	q	781	765	757	749	743	739	736	734	732
		F	-14.4+343R	-6.7+228R	-2.7+171R	-0.3+137R	1.4+114R	2.5+97R	3.4+85R	4.2+76R	4.7+68R
	VSC2 @ 8"	q	829	833	818	823	812	817	809	813	807
		F	-15.1+343R	-7.8+229R	-3.8+171R	-1.7+137R	0+114R	1+98R	1.9+86R	2.5+76R	3.1+68R
	VSC2 @ 6"	q	853	850	848	846	845	844	843	842	842
		F	-15.5+344R	-8.2+229R	-4.5+172R	-2.3+137R	-0.8+114R	0.3+98R	1.1+86R	1.7+76R	2.2+69R
	VSC2 @ 4"	q	875	874	873	872	872	871	871	871	871
		F	-16.1+344R	-8.9+229R	-5.3+172R	-3.1+137R	-1.6+115R	-0.6+98R	0.2+86R	0.8+76R	1.3+69R
18	VSC2 @ 24"	q	926	960	856	894	818	854	797	830	784
		F	-4.7+167R	-1.2+111R	1.6+83R	2.5+66R	4+55R	4.2+47R	5.2+41R	5.2+37R	5.9+33R
	VSC2 @ 18"	q	1068	960	974	980	916	930	941	897	910
		F	-5.7+168R	-1.2+111R	0.6+83R	1.7+67R	3+55R	3.4+47R	3.7+42R	4.5+37R	4.6+33R
	VSC2 @ 12"	q	1068	1052	1043	1036	1030	1026	1023	1021	1019
		F	-5.7+168R	-1.9+112R	0+84R	1.2+67R	1.9+56R	2.5+48R	2.9+42R	3.2+37R	3.5+33R
	VSC2 @ 8"	q	1123	1129	1113	1118	1107	1112	1104	1109	1103
		F	-6.2+168R	-2.7+112R	-0.7+84R	0.3+67R	1.1+56R	1.5+48R	2+42R	2.3+37R	2.6+34R
	VSC2 @ 6"	q	1149	1146	1144	1143	1141	1141	1140	1140	1139
		F	-6.5+168R	-2.9+112R	-1.1+84R	-0.1+67R	0.6+56R	1.2+48R	1.5+42R	1.8+37R	2.1+34R
	VSC2 @ 4"	q	1172	1171	1170	1170	1169	1169	1169	1169	1169
		F	-6.8+168R	-3.3+112R	-1.6+84R	-0.5+67R	0.2+56R	0.7+48R	1+42R	1.3+37R	1.6+34R
16	VSC2 @ 24"	q	1182	1227	1104	1152	1061	1106	1037	1078	1022
		F	-1.2+95R	0.8+63R	2.7+47R	3.1+38R	4.2+31R	4.2+27R	5+23R	4.9+21R	5.5+19R
	VSC2 @ 18"	q	1352	1227	1246	1254	1179	1197	1210	1158	1174
		F	-2+96R	0.8+63R	1.8+47R	2.4+38R	3.4+31R	3.6+27R	3.7+24R	4.3+21R	4.3+19R
	VSC2 @ 12"	q	1352	1336	1327	1319	1313	1309	1306	1303	1301
		F	-2+96R	0.2+64R	1.3+48R	2+38R	2.5+32R	2.8+27R	3+24R	3.2+21R	3.4+19R
	VSC2 @ 8"	q	1416	1423	1405	1412	1400	1406	1397	1402	1395
		F	-2.5+96R	-0.5+64R	0.7+48R	1.2+38R	1.7+32R	2+27R	2.3+24R	2.4+21R	2.6+19R
	VSC2 @ 6"	q	1445	1442	1440	1438	1437	1437	1436	1436	1435
		F	-2.8+96R	-0.7+64R	0.3+48R	1+38R	1.4+32R	1.7+27R	1.9+24R	2.1+21R	2.2+19R
	VSC2 @ 4"	q	1470	1469	1469	1468	1468	1467	1467	1467	1467
		F	-3.1+96R	-1.1+64R	0+48R	0.6+38R	1+32R	1.2+27R	1.5+24R	1.6+21R	1.8+19R

See footnotes on page 28.

Type PLB™ -36

- 36/7/4 Screw Pattern at Supports
#12 or #14 SDI Recognized Screws
to Supports 0.0385" and thicker
- Sidelaps Connected with PunchLok II Tool

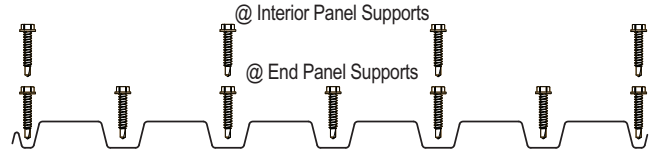

Allowable Diaphragm Shear Strength, q (plf) and Flexibility Factors, F ((in./lb)x10⁶)

DECK GAGE	SIDELAP ATTACHMENT	SPAN (ft.-in.)									
		2'-0"	3'-0"	4'-0"	5'-0"	6'-0"	7'-0"	8'-0"	9'-0"	10'-0"	
22	VSC2 @ 24"	q	687	712	588	614	529	558	499	525	479
		F	5.1+59R	7.3+38R	9.8+27R	10.5+21R	12.4+16R	12.6+14R	14.1+11R	14+10R	15.3+8R
	VSC2 @ 18"	q	895	712	724	720	630	642	650	593	606
		F	4.1+59R	7.3+38R	8.6+28R	9.4+22R	11+17R	11.4+14R	11.6+12R	12.8+10R	12.9+9R
	VSC2 @ 12"	q	895	854	832	810	794	782	773	766	761
		F	4.1+59R	6.4+39R	7.7+28R	8.6+22R	9.2+18R	9.7+15R	10.1+13R	10.4+12R	10.7+10R
	VSC2 @ 8"	q	1024	1034	985	995	962	973	949	960	941
		F	3.5+60R	5.2+39R	6.5+29R	6.9+23R	7.6+19R	7.8+16R	8.2+14R	8.3+12R	8.6+11R
	VSC2 @ 6"	q	1105	1089	1081	1072	1066	1061	1058	1055	1001
		F	3.1+60R	4.8+40R	5.7+29R	6.3+23R	6.7+19R	6.9+17R	7.2+14R	7.3+13R	7.5+12R
	VSC2 @ 4"	q	1193	1186	1182	1178	1175	1173	1172	1171	1001
		F	2.5+60R	4+40R	4.8+30R	5.2+24R	5.6+20R	5.8+17R	6+15R	6.1+13R	6.2+12R
20	VSC2 @ 24"	q	873	915	762	801	696	735	661	697	639
		F	5.1+37R	6.5+24R	8.5+16R	8.8+13R	10.2+10R	10.2+8R	11.4+6R	11.2+6R	12.2+5R
	VSC2 @ 18"	q	1132	915	935	936	826	843	856	785	802
		F	4.2+37R	6.5+24R	7.3+17R	7.8+13R	9.1+10R	9.2+9R	9.3+8R	10.2+6R	10.2+6R
	VSC2 @ 12"	q	1132	1091	1068	1045	1028	1016	1007	1000	994
		F	4.2+37R	5.6+24R	6.5+18R	7.1+14R	7.5+11R	7.8+10R	8.1+8R	8.3+7R	8.4+6R
	VSC2 @ 8"	q	1282	1296	1245	1258	1222	1236	1210	1222	1202
		F	3.6+38R	4.6+25R	5.5+18R	5.7+15R	6.2+12R	6.3+10R	6.6+9R	6.6+8R	6.8+7R
	VSC2 @ 6"	q	1370	1356	1348	1340	1334	1330	1327	1325	1313
		F	3.2+38R	4.3+25R	4.8+19R	5.2+15R	5.4+12R	5.6+11R	5.8+9R	5.9+8R	5.9+7R
	VSC2 @ 4"	q	1461	1454	1451	1448	1446	1444	1443	1442	1313
		F	2.7+38R	3.6+25R	4.1+19R	4.4+15R	4.6+13R	4.7+11R	4.9+9R	4.9+8R	5+8R
18	VSC2 @ 24"	q	1235	1308	1100	1163	1019	1079	975	1030	949
		F	4.3+18R	4.8+11R	6.1+8R	6+6R	6.9+5R	6.7+4R	7.4+3R	7.1+3R	7.7+2R
	VSC2 @ 18"	q	1588	1308	1342	1349	1203	1230	1250	1155	1180
		F	3.4+18R	4.8+11R	5.1+8R	5.3+7R	6+5R	6+4R	6+4R	6.5+3R	6.4+3R
	VSC2 @ 12"	q	1588	1542	1517	1492	1474	1461	1451	1443	1436
		F	3.4+18R	4.1+12R	4.5+9R	4.8+7R	5+6R	5.1+5R	5.2+4R	5.3+4R	5.3+3R
	VSC2 @ 8"	q	1775	1795	1737	1754	1714	1731	1701	1717	1694
		F	3+18R	3.4+12R	3.8+9R	3.9+7R	4.1+6R	4.2+5R	4.3+4R	4.3+4R	4.4+4R
	VSC2 @ 6"	q	1878	1864	1856	1848	1843	1839	1836	1834	1832
		F	2.7+19R	3.2+12R	3.4+9R	3.6+7R	3.7+6R	3.8+5R	3.8+5R	3.9+4R	3.9+4R
	VSC2 @ 4"	q	1978	1972	1969	1966	1964	1963	1962	1961	1960
		F	2.3+19R	2.8+12R	3+9R	3.1+7R	3.2+6R	3.3+5R	3.3+5R	3.4+4R	3.4+4R
16	VSC2 @ 24"	q	1597	1698	1437	1522	1340	1421	1288	1360	1257
		F	3.9+10R	4.2+6R	5.2+4R	5.1+3R	5.9+2R	5.7+2R	6.2+1R	6+1R	6.5+1R
	VSC2 @ 18"	q	2040	1698	1744	1756	1576	1612	1638	1520	1553
		F	3.1+10R	4.2+6R	4.4+5R	4.5+4R	5.1+3R	5+2R	5+2R	5.4+2R	5.4+1R
	VSC2 @ 12"	q	2040	1988	1961	1932	1912	1897	1886	1877	1870
		F	3.1+10R	3.6+7R	3.9+5R	4.1+4R	4.2+3R	4.3+3R	4.3+2R	4.4+2R	4.4+2R
	VSC2 @ 8"	q	2262	2288	2221	2243	2197	2217	2183	2202	2175
		F	2.7+10R	3+7R	3.3+5R	3.3+4R	3.5+3R	3.5+3R	3.6+2R	3.6+2R	3.7+2R
	VSC2 @ 6"	q	2381	2366	2358	2350	2345	2341	2338	2335	2333
		F	2.5+10R	2.8+7R	2.9+5R	3+4R	3.1+3R	3.2+3R	3.2+3R	3.2+2R	3.2+2R
	VSC2 @ 4"	q	2493	2487	2484	2481	2479	2478	2477	2476	2475
		F	2.2+11R	2.4+7R	2.6+5R	2.7+4R	2.7+4R	2.7+3R	2.8+3R	2.8+2R	2.8+2R

See footnotes on page 28.

Type PLB™-36

- 36/7 Screw Pattern at Supports
#12 or #14 SDI Recognized Screws
to Supports 0.0385" and thicker
- Sidelaps Connected with PunchLok II Tool

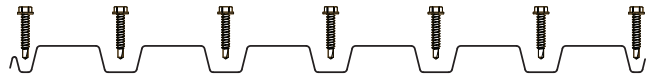

Allowable Diaphragm Shear Strength, q (plf) and Flexibility Factors, F ((in./lb)x10⁶)

DECK GAGE	SIDELAP ATTACHMENT	SPAN (ft-in.)									
		2'-0"	3'-0"	4'-0"	5'-0"	6'-0"	7'-0"	8'-0"	9'-0"	10'-0"	
22	VSC2 @ 24"	q	747	747	617	636	550	575	515	539	493
		F	4.1+60R	6.3+39R	8.5+28R	9.3+22R	10.9+18R	11.3+15R	12.6+12R	12.7+11R	13.8+9R
	VSC2 @ 18"	q	933	747	747	739	648	657	664	606	617
		F	3.5+60R	6.3+39R	7.6+29R	8.5+23R	9.9+18R	10.4+15R	10.7+13R	11.8+11R	11.9+10R
	VSC2 @ 12"	q	933	880	851	825	808	794	784	776	770
		F	3.5+60R	5.6+39R	6.9+29R	7.8+23R	8.5+19R	9+16R	9.4+14R	9.8+12R	10.1+11R
	VSC2 @ 8"	q	1048	1048	997	1004	970	980	956	965	947
		F	3+60R	4.7+40R	6+30R	6.5+24R	7.2+19R	7.4+17R	7.9+14R	8+13R	8.3+11R
	VSC2 @ 6"	q	1120	1100	1088	1078	1071	1066	1062	1059	1001
		F	2.7+60R	4.4+40R	5.4+30R	6+24R	6.4+20R	6.7+17R	6.9+15R	7.1+13R	7.3+12R
	VSC2 @ 4"	q	1200	1190	1185	1181	1178	1175	1174	1172	1001
		F	2.2+61R	3.8+40R	4.6+30R	5.1+24R	5.4+20R	5.7+17R	5.8+15R	6+13R	6.1+12R
20	VSC2 @ 24"	q	940	954	795	826	719	755	679	712	654
		F	4.3+37R	5.8+24R	7.5+17R	7.9+14R	9.2+11R	9.3+9R	10.4+8R	10.3+7R	11.2+6R
	VSC2 @ 18"	q	1171	954	960	956	846	860	870	800	815
		F	3.7+38R	5.8+24R	6.6+18R	7.2+14R	8.3+11R	8.5+10R	8.7+8R	9.5+7R	9.6+6R
	VSC2 @ 12"	q	1171	1117	1087	1061	1043	1029	1018	1010	1003
		F	3.7+38R	5.1+25R	6+18R	6.6+14R	7+12R	7.4+10R	7.6+9R	7.9+8R	8+7R
	VSC2 @ 8"	q	1305	1309	1256	1266	1230	1242	1216	1228	1208
		F	3.2+38R	4.3+25R	5.2+19R	5.5+15R	5.9+12R	6.1+11R	6.4+9R	6.4+8R	6.6+7R
	VSC2 @ 6"	q	1384	1365	1354	1345	1339	1335	1331	1328	1313
		F	2.9+38R	4+25R	4.6+19R	5+15R	5.3+12R	5.5+11R	5.6+9R	5.7+8R	5.8+7R
	VSC2 @ 4"	q	1467	1458	1454	1450	1448	1446	1444	1443	1313
		F	2.5+38R	3.5+25R	4+19R	4.3+15R	4.5+13R	4.7+11R	4.8+9R	4.9+8R	4.9+8R
18	VSC2 @ 24"	q	1317	1354	1140	1193	1048	1103	998	1049	967
		F	3.8+18R	4.5+12R	5.5+8R	5.6+7R	6.4+5R	6.3+5R	6.9+4R	6.8+3R	7.3+3R
	VSC2 @ 18"	q	1632	1354	1371	1372	1227	1250	1267	1172	1195
		F	3.2+18R	4.5+12R	4.8+9R	5+7R	5.7+6R	5.7+5R	5.7+4R	6.2+4R	6.2+3R
	VSC2 @ 12"	q	1632	1572	1539	1510	1490	1475	1463	1454	1446
		F	3.2+18R	3.9+12R	4.3+9R	4.6+7R	4.8+6R	4.9+5R	5+4R	5.1+4R	5.2+3R
	VSC2 @ 8"	q	1798	1808	1748	1763	1722	1737	1708	1722	1699
		F	2.8+19R	3.3+12R	3.7+9R	3.8+7R	4+6R	4.1+5R	4.2+5R	4.2+4R	4.3+4R
	VSC2 @ 6"	q	1891	1873	1862	1854	1848	1843	1840	1837	1835
		F	2.6+19R	3.1+12R	3.4+9R	3.5+7R	3.6+6R	3.7+5R	3.8+5R	3.8+4R	3.9+4R
	VSC2 @ 4"	q	1983	1976	1972	1968	1966	1964	1963	1962	1961
		F	2.3+19R	2.7+12R	3+9R	3.1+7R	3.2+6R	3.3+5R	3.3+5R	3.4+4R	3.4+4R
16	VSC2 @ 24"	q	1694	1751	1484	1558	1375	1449	1316	1383	1279
		F	3.5+10R	3.9+7R	4.8+5R	4.8+4R	5.4+3R	5.3+2R	5.9+2R	5.7+2R	6.1+1R
	VSC2 @ 18"	q	2088	1751	1778	1783	1603	1635	1658	1540	1570
		F	2.9+10R	3.9+7R	4.1+5R	4.3+4R	4.8+3R	4.8+3R	4.8+2R	5.2+2R	5.2+2R
	VSC2 @ 12"	q	2088	2021	1984	1952	1929	1913	1900	1890	1881
		F	2.9+10R	3.4+7R	3.7+5R	3.9+4R	4+3R	4.1+3R	4.2+2R	4.3+2R	4.3+2R
	VSC2 @ 8"	q	2287	2301	2233	2252	2205	2224	2190	2207	2181
		F	2.6+11R	2.9+7R	3.2+5R	3.2+4R	3.4+3R	3.4+3R	3.5+3R	3.5+2R	3.6+2R
	VSC2 @ 6"	q	2395	2375	2365	2356	2349	2345	2341	2339	2336
		F	2.4+11R	2.7+7R	2.9+5R	3+4R	3.1+3R	3.1+3R	3.2+3R	3.2+2R	3.2+2R
	VSC2 @ 4"	q	2499	2491	2487	2484	2481	2479	2478	2477	2476
		F	2.1+11R	2.4+7R	2.5+5R	2.6+4R	2.7+4R	2.7+3R	2.8+3R	2.8+2R	2.8+2R

See footnotes on page 28.

Type PLB™ -36

- 36/9 Screw Pattern at Supports
#12 or #14 SDI Recognized Screws
to Supports 0.0385" and thicker
- Sidelaps Connected with PunchLok II Tool

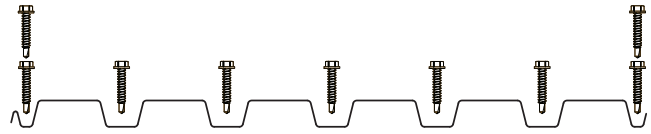

Allowable Diaphragm Shear Strength, q (plf) and Flexibility Factors, F ((in./lb)x10⁶)

DECK GAGE	SIDELAP ATTACHMENT	SPAN (ft.-in.)									
		2'-0"	3'-0"	4'-0"	5'-0"	6'-0"	7'-0"	8'-0"	9'-0"	10'-0"	
22	VSC2 @ 24"	q	987	939	778	772	665	678	605	622	567
		F	3+60R	5.1+39R	6.9+29R	7.8+22R	9.1+18R	9.6+15R	10.7+13R	11+11R	11.9+9R
	VSC2 @ 18"	q	1174	939	913	883	769	766	764	695	701
		F	2.7+60R	5.1+39R	6.4+29R	7.3+23R	8.5+18R	9+15R	9.5+13R	10.4+11R	10.6+10R
	VSC2 @ 12"	q	1174	1081	1027	980	946	921	902	886	874
		F	2.7+60R	4.7+40R	6+29R	6.9+23R	7.6+19R	8.1+16R	8.6+14R	8.9+12R	9.3+11R
	VSC2 @ 8"	q	*1303	*1279	*1201	1199	1145	1152	1114	1123	1001
		F	2.4+60R	4.2+40R	5.4+30R	6+24R	6.6+19R	6.9+17R	7.4+14R	7.5+13R	7.8+11R
	VSC2 @ 6"	q	*1392	*1347	*1321	*1299	*1283	*1271	*1262	1236	1001
		F	2.2+60R	4+40R	4.9+30R	5.6+24R	6+20R	6.3+17R	6.6+15R	6.8+13R	7+12R
	VSC2 @ 4"	q	*1500	*1477	*1464	*1453	*1445	*1439	*1434	1236	1001
		F	1.9+61R	3.5+40R	4.3+30R	4.8+24R	5.2+20R	5.5+17R	5.7+15R	5.8+13R	6+12R
20	VSC2 @ 24"	q	1227	1186	988	993	860	883	791	817	747
		F	3.4+38R	4.8+25R	6.2+18R	6.8+14R	7.9+11R	8.2+9R	9+8R	9.1+7R	9.9+6R
	VSC2 @ 18"	q	1465	1186	1165	1136	996	999	1000	913	923
		F	3+38R	4.8+25R	5.7+18R	6.3+14R	7.3+11R	7.6+10R	7.9+8R	8.6+7R	8.7+6R
	VSC2 @ 12"	q	1465	1366	1309	1258	1222	1195	1174	1158	1144
		F	3+38R	4.5+25R	5.3+18R	5.9+14R	6.4+12R	6.8+10R	7.1+9R	7.3+8R	7.5+7R
	VSC2 @ 8"	q	*1620	*1603	*1518	*1520	1462	1472	1431	1443	1313
		F	2.8+38R	3.9+25R	4.7+19R	5.1+15R	5.6+12R	5.7+10R	6+9R	6.1+8R	6.3+7R
	VSC2 @ 6"	q	*1722	*1679	*1655	*1633	*1618	*1607	*1598	*1591	1313
		F	2.6+38R	3.7+25R	4.3+19R	4.8+15R	5+12R	5.2+11R	5.4+9R	5.5+8R	5.7+7R
	VSC2 @ 4"	q	*1840	*1819	*1808	*1798	*1791	*1785	*1781	*1621	1313
		F	2.3+38R	3.3+25R	3.8+19R	4.2+15R	4.4+13R	4.6+11R	4.7+9R	4.8+8R	4.9+8R
18	VSC2 @ 24"	q	1698	1669	1402	1424	1241	1283	1154	1198	1099
		F	3.2+18R	3.9+12R	4.9+8R	5.1+7R	5.7+5R	5.8+4R	6.3+4R	6.3+3R	6.7+3R
	VSC2 @ 18"	q	*2032	1669	1654	1627	1439	1449	1457	1337	1355
		F	2.8+18R	3.9+12R	4.4+9R	4.6+7R	5.2+5R	5.3+5R	5.4+4R	5.8+3R	5.8+3R
	VSC2 @ 12"	q	*2032	1918	1852	1794	1752	1721	1697	1678	1663
		F	2.8+18R	3.6+12R	4+9R	4.3+7R	4.5+6R	4.7+5R	4.8+4R	4.9+4R	5+3R
	VSC2 @ 8"	q	*2234	*2223	*2124	*2133	*2064	*2080	*2031	*2048	*2007
		F	2.6+19R	3.1+12R	3.5+9R	3.7+7R	3.9+6R	4+5R	4.1+4R	4.1+4R	4.2+4R
	VSC2 @ 6"	q	*2360	*2316	*2291	*2269	*2254	*2242	*2234	*2227	*2007
		F	2.4+19R	3+12R	3.2+9R	3.4+7R	3.6+6R	3.6+5R	3.7+5R	3.8+4R	3.8+4R
	VSC2 @ 4"	q	*2498	*2478	*2467	*2457	*2451	*2446	*2442	*2439	*2007
		F	2.2+19R	2.7+12R	2.9+9R	3.1+7R	3.2+6R	3.2+5R	3.3+5R	3.3+4R	3.4+4R
16	VSC2 @ 24"	q	2171	2151	1815	1854	1622	1681	1516	1577	1450
		F	3+10R	3.5+7R	4.2+5R	4.3+4R	4.9+3R	4.9+2R	5.4+2R	5.3+2R	5.7+1R
	VSC2 @ 18"	q	*2596	2151	2141	2114	1879	1896	1909	1758	1784
		F	2.6+10R	3.5+7R	3.8+5R	4+4R	4.4+3R	4.5+2R	4.5+2R	4.9+2R	4.9+2R
	VSC2 @ 12"	q	*2596	2466	2390	2324	2277	2241	2214	2192	2174
		F	2.6+10R	3.1+7R	3.5+5R	3.7+4R	3.8+3R	3.9+3R	4+2R	4.1+2R	4.2+2R
	VSC2 @ 8"	q	*2844	*2837	*2723	*2736	*2657	*2678	*2621	*2642	*2598
		F	2.4+11R	2.7+7R	3+5R	3.1+4R	3.3+3R	3.3+3R	3.4+2R	3.4+2R	3.5+2R
	VSC2 @ 6"	q	*2994	*2947	*2920	*2897	*2880	*2868	*2859	*2851	*2795
		F	2.3+11R	2.6+7R	2.8+5R	2.9+4R	3+3R	3.1+3R	3.1+3R	3.1+2R	3.2+2R
	VSC2 @ 4"	q	*3153	*3132	*3121	*3111	*3104	*3099	*3095	*3092	*2795
		F	2+11R	2.3+7R	2.5+5R	2.6+4R	2.7+4R	2.7+3R	2.7+3R	2.8+2R	2.8+2R

1. For diaphragm shear strengths in bold and marked with *, the fastening pattern shall be increased at the building perimeter, chords, collectors to other shear transfer elements to two fasteners per rib (i.e. 36/14 pattern) or shall be limited to 1200 plf, 1500 plf, 2000 plf or 2500 plf for 22, 20, 18 or 16 gage steel deck, respectively. Bearing at supports shall allow for proper end distance and fastener spacing.

2. See additional footnotes on page 28.

ShearTranz® II-42 with PLB™ -36 Deck

- 36/7 Weld Pattern at Supports
- Sidelaps Connected with PunchLok II Tool



Allowable Diaphragm Shear Strength, q (plf) and Flexibility Factors, F ((in./lb)x10⁶)

DECK GAGE	SIDELAP ATTACHMENT	SPAN (ft-in.)									
		4'-0"	5'-0"	6'-0"	7'-0"	8'-0"	9'-0"	10'-0"	11'-0"	12'-0"	
22	VSC2 @ 24"	q	700	693	581	594	516	535	482		
		F	9.9-2R	10.4-2R	11.6-3R	11.8-3R	12.9-3R	13-3R	14-3R		
	VSC2 @ 18"	q	842	808	688	685	682	613	618		
		F	9.1-2R	9.6-2R	10.7-2R	11-2R	11.3-2R	12.2-2R	12.3-2R		
	VSC2 @ 12"	q	971	914	875	847	825	808	794		
		F	8.5-1R	9.1-1R	9.5-2R	9.8-1R	10.1-1R	10.4-1R	10.6-1R		
	VSC2 @ 8"	q	1193	1188	1116	1123	1074	1085	1001		
		F	7.7-1R	7.9-1R	8.3-1R	8.4-1R	8.7-1R	8.7-1R	8.9-1R		
	VSC2 @ 6"	q	1370	1334	1309	1290	1276	1236	1001		
		F	7.1-1R	7.3-1R	7.5-1R	7.7-1R	7.8-1R	7.9-1R	7.9-1R		
	VSC2 @ 4"	q	1617	1595	1579	1568	1559	1236	1001		
		F	6.4+0R	6.5+0R	6.6+0R	6.7+0R	6.7+0R	6.8+0R	6.8+0R		
20	VSC2 @ 24"	q	970	960	815	830	727	751	676	703	644
		F	8.3-2R	8.6-2R	9.6-2R	9.7-2R	10.5-2R	10.5-2R	11.3-2R	11.2-2R	11.9-2R
	VSC2 @ 18"	q	1162	1116	953	949	945	850	857	863	797
		F	7.5-1R	7.9-1R	8.8-2R	8.9-1R	9.1-1R	9.8-2R	9.8-1R	9.8-1R	10.4-2R
	VSC2 @ 12"	q	1337	1261	1208	1170	1140	1117	1098	1082	912
		F	7-1R	7.4-1R	7.6-1R	7.9-1R	8.1-1R	8.2-1R	8.4-1R	8.5-1R	8.6-1R
	VSC2 @ 8"	q	1634	1627	1531	1541	1476	1491	1313	1085	912
		F	6.2-1R	6.3-1R	6.6-1R	6.6-1R	6.9-1R	6.9-1R	7-1R	7+0R	7.1+0R
	VSC2 @ 6"	q	1866	1819	1786	1762	1743	1621	1313	1085	912
		F	5.7-1R	5.9+0R	6+0R	6.1+0R	6.2+0R	6.2+0R	6.3+0R	6.3+0R	6.3+0R
	VSC2 @ 4"	q	2184	2156	2137	2122	2052	1621	1313	1085	912
		F	5.1+0R	5.2+0R	5.3+0R	5.3+0R	5.4+0R	5.4+0R	5.4+0R	5.4+0R	5.4+0R
18	VSC2 @ 24"	q	1575	1548	1315	1333	1179	1208	1092	1127	1035
		F	5.9-1R	5.9-1R	6.6-1R	6.5-1R	7-1R	6.9-1R	7.4-1R	7.2-1R	7.6-1R
	VSC2 @ 18"	q	1872	1789	1530	1517	1507	1356	1364	1371	1266
		F	5.2-1R	5.4-1R	5.9-1R	5.9-1R	5.9-1R	6.3-1R	6.3-1R	6.3-1R	6.6-1R
	VSC2 @ 12"	q	2141	2013	1924	1859	1809	1770	1738	1659	1394
		F	4.8-1R	5-1R	5.1+0R	5.2+0R	5.3+0R	5.3+0R	5.4+0R	5.4+0R	5.4+0R
	VSC2 @ 8"	q	2596	2579	2424	2436	2331	2352	2007	1659	1394
		F	4.2+0R	4.2+0R	4.4+0R	4.4+0R	4.5+0R	4.5+0R	4.5+0R	4.5+0R	4.6+0R
	VSC2 @ 6"	q	2954	2875	2820	2778	2747	2478	2007	1659	1394
		F	3.9+0R	4+0R	4+0R	4+0R	4.1+0R	4.1+0R	4.1+0R	4.1+0R	4.1+0R
	VSC2 @ 4"	q	3446	3398	3365	3340	3136	2478	2007	1659	1394
		F	3.5+0R	3.6+0R	3.6+0R	3.6+0R	3.6+0R	3.6+0R	3.6+0R	3.6+0R	3.6+0R
16	VSC2 @ 24"	q	2037	2018	1717	1749	1548	1593	1445	1492	1376
		F	4.9-1R	4.9-1R	5.5-1R	5.4-1R	5.9-1R	5.7-1R	6.1-1R	6-1R	6.3-1R
	VSC2 @ 18"	q	2434	2340	2005	1996	1989	1792	1807	1819	1682
		F	4.4-1R	4.4-1R	4.9-1R	4.9-1R	4.9-1R	5.3-1R	5.2-1R	5.2+0R	5.5-1R
	VSC2 @ 12"	q	2789	2635	2529	2450	2390	2342	2304	2272	1941
		F	4+0R	4.1+0R	4.2+0R	4.3+0R	4.3+0R	4.4+0R	4.4+0R	4.4+0R	4.5+0R
	VSC2 @ 8"	q	3381	3369	3178	3199	3069	3098	2795	2310	1941
		F	3.5+0R	3.5+0R	3.6+0R	3.6+0R	3.7+0R	3.6+0R	3.7+0R	3.7+0R	3.7+0R
	VSC2 @ 6"	q	3833	3743	3679	3632	3596	3451	2795	2310	1941
		F	3.2+0R	3.2+0R	3.3+0R	3.3+0R	3.3+0R	3.3+0R	3.3+0R	3.3+0R	3.3+0R
	VSC2 @ 4"	q	4436	4384	4347	4320	4300	3451	2795	2310	1941
		F	2.9+0R	2.9+0R	2.9+0R	2.9+0R	2.9+0R	2.9+0R	2.9+0R	2.9+0R	2.9+0R

1. See page 66 for ShearTranz II-42 element installation details.
 2. See footnotes on page 28.

ShearTranz® II-42 Element Installation Instructions

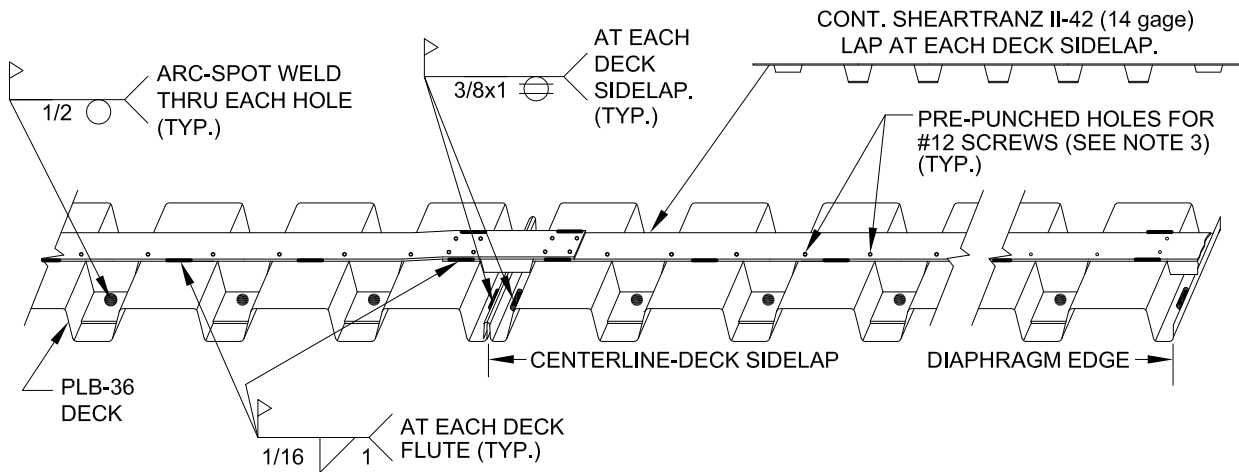

NOTE: CONTINUOUS RIB IN TOP FLANGE OF SHEARTRANZ II-42 NOT SHOWN FOR CLARITY.

NOTES:

- 1) WELD BOTH SIDES ADJACENT TO DECK SIDELAP.
 - 2) WELD BOTH SIDES AT EDGE OF DIAPHRAGM.
- ALTERNATE ATTACHMENT:**
- 3) #12 SCREWS THRU PRE-PUNCHED HOLES AT LOCATIONS SHOWN ARE PERMITTED TO REPLACE WELDS

SECTION 1: SHEARTRANZ II-42 FOR PLB-36 DECK with THE PUNCHLOK II SYSTEM with VSC2 SIDELAP CONNECTIONS MADE WITH THE PUNCHLOK II TOOL

ShearTranz® II-42 Details

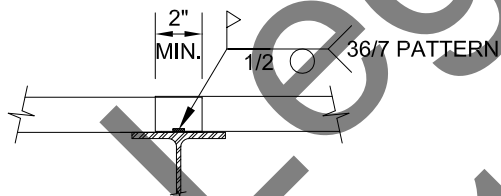

NOTE: LAP DECK MIN. 2" AT END LAPS.
TYPICAL INTERIOR SUPPORT

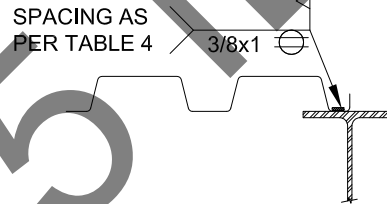

ATTACHMENT AT PARALLEL SUPPORTS

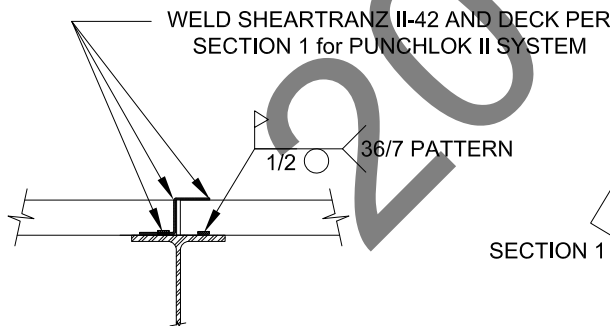

TYPICAL BUTT JOINT

SHEARTRANZ II-42 CONTINUOUS AT BUTT JOINTS. WELD TOP FLANGE OF SHEARTRANZ II-42 TO BOTH PIECES OF DECK AT BUTT JOINTS.

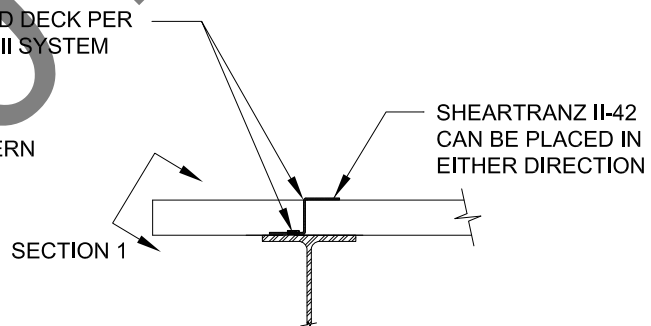

DETAIL AT DIAPHRAGM PERIMETER

DECK MAY BE CANTILEVERED OR STOP AT BEAM.

Type HSB®-36

- 36/4 Weld Pattern at Supports
- Sidelaps connected with Button Punch or 1½" Top Seam Weld



Allowable Diaphragm Shear Strength, q (plf) and Flexibility Factors, F ((in./lb)x10⁶)

DECK GAGE	SIDELAP ATTACHMENT	SPAN (ft-in.)									
		4'-0"	5'-0"	6'-0"	7'-0"	8'-0"	9'-0"	10'-0"	11'-0"	12'-0"	
22	BP @ 24"	q	282	234	190	169	144	135	121		
		F	-1.3+267R	4.2+212R	9.1+174R	12.6+148R	16.3+127R	18.9+112R	22.1+98R		
	BP @ 12"	q	318	262	226	199	180	167	157		
		F	-2.3+267R	3.1+212R	7.2+175R	10.5+149R	13.3+129R	15.7+114R	17.9+101R		
	TSW @ 24"	q	628	649	562	588	526	552	505		
		F	-9.4+271R	-6.3+217R	-3.5+181R	-2.2+155R	-0.5+135R	0.1+120R	1.2+108R		
	TSW @ 18"	q	763	756	663	673	681	622	633		
		F	-10.2+271R	-6.9+217R	-4.2+181R	-2.8+155R	-1.7+136R	-0.4+121R	0.2+108R		
	TSW @ 12"	q	871	846	828	815	805	798	791		
		F	-10.7+272R	-7.3+217R	-5.1+181R	-3.5+155R	-2.3+136R	-1.3+121R	-0.6+109R		
	TSW @ 6"	q	1117	1107	1101	1096	1092	1089	1001		
		F	-11.6+272R	-8.2+217R	-6+181R	-4.4+155R	-3.2+136R	-2.3+121R	-1.5+109R		
20	BP @ 24"	q	403	336	275	246	211	195	175	169	155
		F	3.1+167R	7.2+132R	11.1+108R	13.8+91R	16.9+78R	19+68R	21.7+59R	23.4+53R	25.8+47R
	BP @ 12"	q	454	378	326	290	262	241	227	216	206
		F	2.2+168R	6.2+133R	9.3+109R	11.9+93R	14.2+80R	16.1+70R	17.8+62R	19.4+55R	20.8+50R
	TSW @ 24"	q	824	846	733	764	685	715	654	683	634
		F	-4.2+171R	-2.3+137R	-0.4+114R	0.3+98R	1.5+86R	1.9+76R	2.7+68R	2.8+62R	3.4+57R
	TSW @ 18"	q	993	981	861	872	879	804	818	829	774
		F	-5+172R	-2.9+137R	-1.1+114R	-0.2+98R	0.5+86R	1.4+76R	1.8+69R	2.1+62R	2.6+57R
	TSW @ 12"	q	1127	1093	1069	1051	1037	1026	1018	1010	912
		F	-5.5+172R	-3.3+137R	-1.9+115R	-0.8+98R	0+86R	0.6+76R	1+69R	1.4+62R	1.8+57R
	TSW @ 6"	q	1435	1422	1412	1406	1400	1396	1313	1085	912
		F	-6.2+172R	-4.1+138R	-2.7+115R	-1.7+98R	-0.9+86R	-0.3+76R	0.1+69R	0.5+63R	0.8+57R
18	BP @ 24"	q	704	592	487	438	379	353	314	300	275
		F	6.3+80R	9.1+63R	11.9+51R	13.9+42R	16.3+35R	17.8+30R	20+26R	21.3+22R	23.3+19R
	BP @ 12"	q	794	666	579	517	470	434	405	383	366
		F	5.5+81R	8.2+63R	10.4+52R	12.2+43R	13.9+37R	15.3+32R	16.7+28R	17.9+24R	19+22R
	TSW @ 24"	q	1272	1293	1121	1160	1040	1081	989	1028	955
		F	0+84R	0.8+67R	1.9+56R	2.2+48R	2.9+42R	3+37R	3.5+33R	3.5+30R	3.9+28R
	TSW @ 18"	q	1513	1486	1306	1316	1323	1210	1227	1241	1160
		F	-0.7+84R	0.3+67R	1.3+56R	1.7+48R	2+42R	2.6+37R	2.7+33R	2.9+30R	3.2+28R
	TSW @ 12"	q	1705	1648	1607	1577	1554	1535	1520	1508	1394
		F	-1.1+84R	-0.1+67R	0.7+56R	1.2+48R	1.6+42R	1.9+37R	2.1+34R	2.3+30R	2.5+28R
	TSW @ 6"	q	2150	2127	2111	2099	2090	2083	2007	1659	1394
		F	-1.8+84R	-0.8+67R	-0.1+56R	0.4+48R	0.8+42R	1.1+37R	1.3+34R	1.5+31R	1.7+28R
16	BP @ 24"	q	912	778	641	584	506	477	425	408	371
		F	7.1+44R	9.2+34R	11.5+27R	13.1+22R	15.1+18R	16.4+15R	18.3+12R	19.4+10R	21.2+8R
	BP @ 12"	q	1041	893	784	707	649	604	568	538	514
		F	6.4+45R	8.4+35R	10.1+28R	11.6+23R	13+19R	14.2+16R	15.3+14R	16.3+12R	17.3+10R
	TSW @ 24"	q	1643	1679	1460	1515	1361	1417	1299	1352	1257
		F	1.4+48R	1.8+38R	2.6+32R	2.7+27R	3.2+24R	3.2+21R	3.6+19R	3.5+17R	3.8+16R
	TSW @ 18"	q	1957	1929	1702	1718	1731	1586	1610	1630	1525
		F	0.8+48R	1.3+38R	2.1+32R	2.3+27R	2.4+24R	2.8+21R	2.9+19R	2.9+17R	3.2+16R
	TSW @ 12"	q	2203	2136	2088	2053	2026	2004	1986	1971	1941
		F	0.4+48R	1+38R	1.5+32R	1.8+27R	2+24R	2.2+21R	2.3+19R	2.4+17R	2.5+16R
	TSW @ 6"	q	2753	2727	2710	2696	2686	2678	2671	2310	1941
		F	-0.2+48R	0.4+38R	0.8+32R	1.1+27R	1.3+24R	1.5+21R	1.6+19R	1.7+17R	1.8+16R

See footnotes on page 28.

Type HSB®-36

- 36/5 Weld Pattern at Supports
- Sidelaps connected with Button Punch or 1½" Top Seam Weld



Allowable Diaphragm Shear Strength, q (plf) and Flexibility Factors, F ((in./lb)x10⁶)

DECK GAGE	SIDELAP ATTACHMENT	SPAN (ft.-in.)									
		4'-0"	5'-0"	6'-0"	7'-0"	8'-0"	9'-0"	10'-0"	11'-0"	12'-0"	
22	BP @ 24"	q	369	303	248	218	187	174	156		
		F	1.5+187R	5.7+148R	9.5+122R	12.3+103R	15.2+88R	17.3+77R	19.9+68R		
	BP @ 12"	q	405	332	284	249	223	205	192		
		F	0.8+188R	5+149R	8.2+123R	10.8+104R	13.1+90R	15.1+79R	16.9+70R		
	TSW @ 24"	q	714	724	623	644	575	598	545		
		F	-4.6+191R	-2.5+153R	-0.4+127R	0.5+109R	1.8+95R	2.2+85R	3.1+76R		
	TSW @ 18"	q	857	839	731	736	739	672	682		
		F	-5.4+191R	-3.1+153R	-1.1+127R	0+109R	0.8+95R	1.7+85R	2.2+76R		
	TSW @ 12"	q	977	939	913	894	879	867	857		
		F	-5.9+191R	-3.5+153R	-1.8+127R	-0.7+109R	0.2+96R	0.9+85R	1.4+76R		
	TSW @ 6"	q	1275	1258	1246	1237	1231	1225	1001		
		F	-6.7+191R	-4.3+153R	-2.7+128R	-1.6+109R	-0.8+96R	-0.1+85R	0.4+77R		
20	BP @ 24"	q	524	433	356	315	271	249	224	213	195
		F	4.3+117R	7.5+92R	10.5+75R	12.7+63R	15.2+54R	17+47R	19.2+40R	20.6+36R	22.7+31R
	BP @ 12"	q	576	475	407	359	323	295	275	260	247
		F	3.7+118R	6.8+93R	9.3+76R	11.4+64R	13.3+55R	14.9+48R	16.4+42R	17.8+38R	19+34R
	TSW @ 24"	q	944	951	819	843	752	779	711	737	683
		F	-1.2+121R	0+96R	1.5+80R	2+69R	3+60R	3.2+53R	3.8+48R	3.9+44R	4.4+40R
	TSW @ 18"	q	1125	1097	956	959	962	874	885	894	832
		F	-2+121R	-0.5+97R	0.9+80R	1.5+69R	2+60R	2.7+54R	3+48R	3.2+44R	3.6+40R
	TSW @ 12"	q	1276	1224	1188	1160	1139	1123	1109	1085	912
		F	-2.4+121R	-0.8+97R	0.2+81R	0.9+69R	1.5+60R	1.9+54R	2.3+48R	2.5+44R	2.8+40R
	TSW @ 6"	q	1655	1631	1615	1602	1593	1585	1313	1085	912
		F	-3.1+121R	-1.6+97R	-0.6+81R	0.1+69R	0.6+61R	1+54R	1.4+48R	1.7+44R	1.9+40R
18	BP @ 24"	q	909	757	624	556	482	444	396	375	343
		F	6.2+56R	8.4+44R	10.6+35R	12.2+29R	14.2+24R	15.6+20R	17.3+17R	18.5+14R	20.2+12R
	BP @ 12"	q	989	830	716	634	573	525	487	458	435
		F	5.6+56R	7.8+44R	9.6+36R	11.1+29R	12.5+25R	13.8+21R	15+18R	16+16R	17+14R
	TSW @ 24"	q	1479	1472	1269	1295	1155	1190	1085	1120	1037
		F	1.3+59R	1.9+47R	2.8+39R	3+33R	3.6+29R	3.6+26R	4+23R	4+21R	4.4+19R
	TSW @ 18"	q	1739	1685	1468	1465	1462	1329	1341	1351	1257
		F	0.7+59R	1.4+47R	2.3+39R	2.5+34R	2.7+29R	3.2+26R	3.3+23R	3.4+21R	3.7+20R
	TSW @ 12"	q	1958	1871	1808	1762	1725	1697	1673	1654	1394
		F	0.3+59R	1.1+47R	1.6+39R	2+34R	2.3+29R	2.5+26R	2.7+24R	2.8+21R	3+20R
	TSW @ 6"	q	2520	2479	2449	2427	2410	2397	2007	1659	1394
		F	-0.3+59R	0.4+47R	0.9+39R	1.3+34R	1.6+30R	1.8+26R	1.9+24R	2.1+22R	2.2+20R
16	BP @ 24"	q	1161	984	812	731	634	591	527	501	457
		F	6.4+31R	8.2+24R	10+18R	11.4+15R	13+12R	14.2+9R	15.7+7R	16.7+6R	18.2+4R
	BP @ 12"	q	1285	1098	955	854	777	718	670	631	600
		F	6+31R	7.6+24R	9.1+19R	10.4+15R	11.5+13R	12.6+11R	13.6+9R	14.5+7R	15.4+6R
	TSW @ 24"	q	1904	1907	1647	1687	1508	1557	1422	1471	1363
		F	2.1+33R	2.4+27R	3.1+22R	3.1+19R	3.5+17R	3.5+15R	3.8+13R	3.8+12R	4+11R
	TSW @ 18"	q	2246	2185	1909	1910	1911	1741	1759	1774	1652
		F	1.6+34R	2+27R	2.6+22R	2.7+19R	2.8+17R	3.1+15R	3.2+13R	3.2+12R	3.4+11R
	TSW @ 12"	q	2529	2424	2350	2295	2252	2218	2190	2167	1941
		F	1.2+34R	1.7+27R	2+22R	2.2+19R	2.4+17R	2.5+15R	2.6+13R	2.7+12R	2.8+11R
	TSW @ 6"	q	3232	3185	3152	3127	3108	3093	2795	2310	1941
		F	0.7+34R	1.1+27R	1.4+23R	1.6+19R	1.7+17R	1.9+15R	2+14R	2+12R	2.1+11R

See footnotes on page 28.

Type HSB®-36

- 36/7/4 Weld Pattern at Supports
- Sidelaps connected with Button Punch or 1½" Top Seam Weld

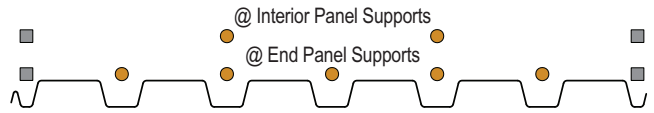

Allowable Diaphragm Shear Strength, q (plf) and Flexibility Factors, F ((in./lb)x10⁶)

DECK GAGE	SIDELAP ATTACHMENT	SPAN (ft-in.)									
		4'-0"	5'-0"	6'-0"	7'-0"	8'-0"	9'-0"	10'-0"	11'-0"	12'-0"	
22	BP @ 24"	q	340	280	229	202	173	161	145		
		F	12.3+24R	14.7+17R	17.3+12R	19.3+8R	21.8+4R	23.4+2R	25.7-1R		
	BP @ 12"	q	376	309	264	233	209	192	180		
		F	11.5+25R	13.8+18R	15.8+13R	17.6+9R	19.3+6R	20.8+4R	22.3+2R		
	TSW @ 24"	q	722	739	627	654	572	604	543		
		F	5.4+30R	5.5+24R	6.3+19R	6.2+17R	6.8+15R	6.7+13R	7.1+12R		
	TSW @ 18"	q	894	876	750	758	764	688	700		
		F	4.6+30R	4.9+24R	5.6+20R	5.7+17R	5.7+15R	6.2+13R	6.2+12R		
	TSW @ 12"	q	1047	1002	971	948	931	918	907		
		F	4.1+30R	4.5+24R	4.8+20R	5+17R	5.2+15R	5.3+13R	5.4+12R		
	TSW @ 6"	q	1484	1458	1441	1428	1418	1236	1001		
		F	3.2+30R	3.6+24R	3.9+20R	4.1+17R	4.2+15R	4.3+14R	4.4+12R		
20	BP @ 24"	q	484	401	329	292	251	231	208	198	182
		F	11.4+14R	13.5+9R	15.8+5R	17.6+2R	19.8+0R	21.3-2R	23.4-4R	24.7-5R	26.7-7R
	BP @ 12"	q	535	442	380	336	303	277	259	245	233
		F	10.7+14R	12.7+10R	14.5+6R	16.1+4R	17.5+2R	18.9+0R	20.2-1R	21.4-3R	22.5-4R
	TSW @ 24"	q	958	973	826	856	754	789	710	746	684
		F	5.1+18R	5.1+15R	5.8+12R	5.7+10R	6.2+9R	6+8R	6.4+7R	6.2+7R	6.6+6R
	TSW @ 18"	q	1177	1149	983	989	995	896	910	921	852
		F	4.4+19R	4.6+15R	5.1+12R	5.2+11R	5.2+9R	5.5+8R	5.5+7R	5.5+7R	5.7+6R
	TSW @ 12"	q	1373	1310	1266	1234	1210	1191	1176	1085	912
		F	3.9+19R	4.2+15R	4.4+13R	4.5+11R	4.6+9R	4.7+8R	4.8+8R	4.8+7R	4.9+6R
	TSW @ 6"	q	1940	1904	1879	1861	1847	1621	1313	1085	912
		F	3.1+19R	3.4+15R	3.6+13R	3.7+11R	3.8+10R	3.8+9R	3.9+8R	3.9+7R	4+6R
18	BP @ 24"	q	842	702	579	517	447	414	368	350	321
		F	9.9+5R	11.7+2R	13.6-1R	15.1-2R	17-4R	18.2-5R	20-6R	21.1-7R	22.9-8R
	BP @ 12"	q	933	775	670	595	539	495	460	433	412
		F	9.3+5R	11+2R	12.4+1R	13.8-1R	15-2R	16.2-3R	17.3-4R	18.3-5R	19.3-6R
	TSW @ 24"	q	1504	1508	1280	1315	1163	1204	1088	1132	1040
		F	4.5+9R	4.4+7R	4.9+6R	4.8+5R	5.2+4R	5+4R	5.3+3R	5.2+3R	5.4+3R
	TSW @ 18"	q	1826	1768	1510	1512	1514	1362	1378	1392	1286
		F	3.8+9R	3.9+7R	4.4+6R	4.3+5R	4.3+4R	4.6+4R	4.6+3R	4.5+3R	4.7+3R
	TSW @ 12"	q	2117	2008	1932	1877	1835	1802	1775	1659	1394
		F	3.4+9R	3.6+7R	3.7+6R	3.8+5R	3.8+5R	3.9+4R	3.9+4R	4+3R	4+3R
	TSW @ 6"	q	2981	2916	2870	2837	2811	2478	2007	1659	1394
		F	2.8+9R	2.9+7R	3+6R	3+5R	3.1+5R	3.1+4R	3.2+4R	3.2+3R	3.2+3R
16	BP @ 24"	q	1083	915	755	682	591	553	493	470	428
		F	8.8+1R	10.3-1R	12.1-2R	13.4-4R	15-5R	16.2-6R	17.8-7R	18.7-8R	20.3-9R
	BP @ 12"	q	1227	1030	898	805	734	680	636	600	571
		F	8.3+2R	9.7+0R	11-2R	12.2-3R	13.3-4R	14.3-4R	15.3-5R	16.2-5R	17.1-6R
	TSW @ 24"	q	1945	1963	1668	1721	1524	1583	1435	1492	1376
		F	4+5R	3.8+4R	4.3+3R	4.1+3R	4.5+2R	4.3+2R	4.6+2R	4.4+2R	4.7+1R
	TSW @ 18"	q	2372	2306	1974	1983	1989	1792	1817	1837	1699
		F	3.4+5R	3.4+4R	3.8+3R	3.7+3R	3.7+2R	4+2R	3.9+2R	3.9+2R	4.1+2R
	TSW @ 12"	q	2753	2621	2529	2462	2411	2371	2339	2310	1941
		F	3+5R	3.1+4R	3.2+3R	3.3+3R	3.3+3R	3.3+2R	3.3+2R	3.4+2R	3.4+2R
	TSW @ 6"	q	3855	3780	3727	3689	3659	3451	2795	2310	1941
		F	2.4+5R	2.5+4R	2.6+4R	2.6+3R	2.6+3R	2.6+2R	2.7+2R	2.7+2R	2.7+2R

See footnotes on page 28.

Type HSB®-36

- 36/7 Weld Pattern at Supports
- Sidelaps connected with Button Punch or 1½" Top Seam Weld



Allowable Diaphragm Shear Strength, q (plf) and Flexibility Factors, F ((in./lb)x10⁶)

DECK GAGE	SIDELAP ATTACHMENT	SPAN (ft.-in.)									
		4'-0"	5'-0"	6'-0"	7'-0"	8'-0"	9'-0"	10'-0"	11'-0"	12'-0"	
22	BP @ 24"	q	398	327	267	235	202	186	168		
		F	9.9+27R	11.9+20R	14+15R	15.7+12R	17.6+9R	19.1+7R	20.9+5R		
	BP @ 12"	q	434	355	303	266	238	218	204		
		F	9.5+27R	11.4+21R	13.1+16R	14.6+13R	16.1+10R	17.4+8R	18.7+6R		
	TSW @ 24"	q	770	777	661	682	601	627	566		
		F	5.1+30R	5.3+24R	6.1+20R	6.1+17R	6.6+15R	6.5+13R	7+12R		
	TSW @ 18"	q	937	911	781	785	787	710	720		
		F	4.4+30R	4.8+24R	5.4+20R	5.5+17R	5.6+15R	6+13R	6.1+12R		
	TSW @ 12"	q	1084	1033	998	972	952	936	924		
		F	4+30R	4.4+24R	4.7+20R	4.9+17R	5.1+15R	5.2+13R	5.3+12R		
	TSW @ 6"	q	1504	1476	1456	1442	1430	1236	1001		
		F	3.2+30R	3.6+24R	3.8+20R	4+17R	4.2+15R	4.3+14R	4.4+12R		
20	BP @ 24"	q	564	466	383	338	292	267	240	228	209
		F	9.3+16R	11+12R	12.8+8R	14.3+6R	16+4R	17.3+2R	19+1R	20.1+0R	21.7-1R
	BP @ 12"	q	616	507	434	382	343	313	292	274	260
		F	8.8+16R	10.5+12R	12+9R	13.3+7R	14.6+5R	15.8+3R	16.9+2R	18+1R	19+0R
	TSW @ 24"	q	1024	1026	873	896	793	821	742	772	711
		F	4.8+19R	4.9+15R	5.6+12R	5.5+11R	6+9R	5.8+8R	6.2+7R	6.1+7R	6.4+6R
	TSW @ 18"	q	1236	1197	1026	1027	1028	926	937	946	875
		F	4.2+19R	4.4+15R	5+13R	5+11R	5.1+9R	5.4+8R	5.4+7R	5.4+7R	5.7+6R
	TSW @ 12"	q	1425	1354	1304	1267	1239	1217	1200	1085	912
		F	3.8+19R	4.1+15R	4.3+13R	4.5+11R	4.6+10R	4.7+8R	4.7+8R	4.8+7R	4.8+6R
	TSW @ 6"	q	1970	1930	1901	1880	1864	1621	1313	1085	912
		F	3.1+19R	3.4+15R	3.5+13R	3.7+11R	3.7+10R	3.8+9R	3.9+8R	3.9+7R	4+6R
18	BP @ 24"	q	979	812	670	595	516	475	423	400	366
		F	8.1+7R	9.5+4R	11+2R	12.2+1R	13.7+0R	14.8-1R	16.2-2R	17.2-3R	18.6-4R
	BP @ 12"	q	1070	885	761	673	607	556	515	483	458
		F	7.7+7R	9+5R	10.3+3R	11.4+2R	12.5+1R	13.5+0R	14.4-1R	15.3-2R	16.2-2R
	TSW @ 24"	q	1617	1598	1359	1383	1224	1258	1141	1177	1085
		F	4.3+9R	4.2+7R	4.7+6R	4.6+5R	5+4R	4.9+4R	5.2+3R	5+3R	5.3+3R
	TSW @ 18"	q	1928	1851	1586	1577	1570	1414	1425	1434	1326
		F	3.7+9R	3.8+7R	4.2+6R	4.2+5R	4.2+4R	4.5+4R	4.5+4R	4.4+3R	4.7+3R
	TSW @ 12"	q	2208	2084	1998	1935	1886	1848	1817	1659	1394
		F	3.4+9R	3.5+7R	3.6+6R	3.7+5R	3.8+5R	3.8+4R	3.9+4R	3.9+3R	3.9+3R
	TSW @ 6"	q	3036	2962	2910	2872	2842	2478	2007	1659	1394
		F	2.7+9R	2.9+8R	3+6R	3+5R	3.1+5R	3.1+4R	3.1+4R	3.2+3R	3.2+3R
16	BP @ 24"	q	1255	1052	869	780	677	629	561	532	485
		F	7.2+3R	8.4+1R	9.7+0R	10.8-1R	12.1-2R	13.1-2R	14.3-3R	15.2-4R	16.4-4R
	BP @ 12"	q	1395	1167	1013	902	820	756	704	662	628
		F	6.8+3R	8+2R	9.1+1R	10.1+0R	11-1R	11.9-2R	12.7-2R	13.5-3R	14.3-3R
	TSW @ 24"	q	2083	2073	1766	1805	1599	1649	1497	1548	1428
		F	3.7+5R	3.7+4R	4.1+3R	4+3R	4.3+2R	4.2+2R	4.5+2R	4.3+2R	4.6+1R
	TSW @ 18"	q	2496	2408	2067	2062	2058	1856	1874	1889	1748
		F	3.2+5R	3.3+4R	3.7+3R	3.6+3R	3.6+2R	3.9+2R	3.8+2R	3.8+2R	4+2R
	TSW @ 12"	q	2862	2713	2609	2532	2473	2427	2389	2310	1941
		F	2.9+5R	3.1+4R	3.1+3R	3.2+3R	3.2+3R	3.3+2R	3.3+2R	3.3+2R	3.4+2R
	TSW @ 6"	q	3918	3833	3773	3729	3695	3451	2795	2310	1941
		F	2.4+5R	2.5+4R	2.5+4R	2.6+3R	2.6+3R	2.6+2R	2.6+2R	2.7+2R	2.7+2R

See footnotes on page 28.

Type HSB®-36-SS

- 36/4 Screw Pattern at Supports
#12 or #14 SDI Recognized Screws
at Supports 0.0385" and thicker
- Sidelaps Connected with #10 Screws



Allowable Diaphragm Shear Strength, q (plf) and Flexibility Factors, F ((in./lb)x10⁶)

DECK GAGE	SIDELAP ATTACHMENT	SPAN (ft-in.)									
		2'-0"	3'-0"	4'-0"	5'-0"	6'-0"	7'-0"	8'-0"	9'-0"	10'-0"	
22	#10 @ 24"	q	394	355	290	277	235	233	203	206	185
		F	-24.9+542R	-13.3+361R	-6.2+270R	-2.9+216R	0.5+179R	1.8+154R	4.1+134R	4.6+119R	6.2+107R
	#10 @ 18"	q	458	355	334	314	269	263	258	232	231
		F	-26.1+543R	-13.3+361R	-7.5+271R	-4.1+216R	-0.8+180R	0.7+154R	1.9+135R	3.6+120R	4.2+108R
	#10 @ 12"	q	458	405	374	348	329	315	305	296	289
		F	-26.1+543R	-14.4+361R	-8.4+271R	-4.9+217R	-2.4+180R	-0.7+155R	0.6+135R	1.6+120R	2.4+108R
	#10 @ 8"	q	510	485	443	434	406	405	386	387	373
		F	-26.8+543R	-15.5+362R	-9.5+271R	-6.2+217R	-3.7+181R	-2.2+155R	-0.8+136R	0+120R	0.9+108R
	#10 @ 6"	q	551	517	498	481	468	459	452	447	442
		F	-27.2+543R	-15.9+362R	-10.2+271R	-6.8+217R	-4.5+181R	-2.8+155R	-1.6+136R	-0.7+121R	0.1+109R
	#10 @ 4"	q	609	588	575	565	557	552	547	544	541
		F	-27.8+543R	-16.5+362R	-10.9+272R	-7.5+217R	-5.3+181R	-3.6+155R	-2.4+136R	-1.5+121R	-0.7+109R
20	#10 @ 24"	q	481	438	359	346	295	295	258	262	236
		F	-13.7+343R	-6.3+228R	-1.3+170R	0.7+136R	3.3+113R	4+97R	5.7+84R	6+75R	7.2+67R
	#10 @ 18"	q	563	438	415	393	337	331	326	294	294
		F	-14.8+343R	-6.3+228R	-2.5+171R	-0.3+137R	2.1+114R	3+97R	3.7+85R	5+75R	5.4+68R
	#10 @ 12"	q	563	502	466	436	414	398	386	376	368
		F	-14.8+343R	-7.2+229R	-3.4+171R	-1+137R	0.6+114R	1.7+98R	2.6+85R	3.2+76R	3.8+68R
	#10 @ 8"	q	628	602	552	544	511	511	488	491	474
		F	-15.4+344R	-8.3+229R	-4.4+172R	-2.3+137R	-0.6+114R	0.3+98R	1.2+86R	1.8+76R	2.4+69R
	#10 @ 6"	q	677	640	619	600	587	577	569	563	558
		F	-15.8+344R	-8.6+229R	-4.9+172R	-2.8+137R	-1.3+114R	-0.2+98R	0.5+86R	1.1+76R	1.6+69R
	#10 @ 4"	q	746	724	711	699	691	685	681	677	674
		F	-16.3+344R	-9.2+229R	-5.6+172R	-3.4+138R	-2+115R	-1+98R	-0.2+86R	0.4+76R	0.9+69R
18	#10 @ 24"	q	659	611	502	490	419	422	375	383	346
		F	-4.3+167R	-0.5+111R	2.5+83R	3.4+66R	5.1+55R	5.4+47R	6.5+41R	6.5+36R	7.5+32R
	#10 @ 18"	q	779	611	585	559	482	476	472	427	428
		F	-5.2+167R	-0.5+111R	1.4+83R	2.5+66R	4+55R	4.5+47R	4.8+41R	5.7+36R	5.8+33R
	#10 @ 12"	q	779	703	659	621	594	574	559	547	537
		F	-5.2+167R	-1.3+111R	0.7+83R	1.9+67R	2.8+55R	3.4+48R	3.8+42R	4.2+37R	4.5+33R
	#10 @ 8"	q	868	842	779	772	730	732	703	708	686
		F	-5.8+168R	-2.2+112R	-0.2+84R	0.8+67R	1.7+56R	2.2+48R	2.7+42R	2.9+37R	3.3+33R
	#10 @ 6"	q	935	893	869	847	832	821	812	805	799
		F	-6.1+168R	-2.5+112R	-0.7+84R	0.4+67R	1.1+56R	1.7+48R	2.1+42R	2.4+37R	2.6+34R
	#10 @ 4"	q	1023	999	985	973	965	958	953	949	946
		F	-6.6+168R	-3+112R	-1.3+84R	-0.2+67R	0.5+56R	1+48R	1.4+42R	1.7+37R	1.9+34R
16	#10 @ 24"	q	844	793	654	644	553	561	499	511	466
		F	-0.7+95R	1.5+63R	3.6+47R	4.2+37R	5.4+31R	5.5+26R	6.4+23R	6.3+20R	7.1+18R
	#10 @ 18"	q	1004	793	766	737	638	634	630	571	575
		F	-1.6+95R	1.5+63R	2.7+47R	3.4+38R	4.5+31R	4.7+27R	4.9+23R	5.6+21R	5.7+19R
	#10 @ 12"	q	1004	915	864	819	788	764	746	732	720
		F	-1.6+95R	0.8+63R	2+47R	2.8+38R	3.3+31R	3.7+27R	4+24R	4.2+21R	4.4+19R
	#10 @ 8"	q	1119	1092	1018	1013	963	967	933	940	913
		F	-2.1+96R	0+64R	1.3+48R	1.8+38R	2.4+32R	2.6+27R	3+24R	3.1+21R	3.3+19R
	#10 @ 6"	q	1201	1156	1129	1106	1090	1077	1068	1060	1054
		F	-2.4+96R	-0.3+64R	0.8+48R	1.5+38R	1.9+32R	2.2+27R	2.4+24R	2.6+21R	2.8+19R
	#10 @ 4"	q	1306	1281	1267	1255	1246	1240	1235	1231	1227
		F	-2.8+96R	-0.7+64R	0.3+48R	0.9+38R	1.3+32R	1.6+27R	1.9+24R	2+21R	2.2+19R

See footnotes on page 28.

Type HSB®-36-SS

- 36/7/4 Screw Pattern at Supports
#12 or #14 SDI Recognized Screws
at Supports 0.0385" and thicker
- Sidelaps Connected with #10 Screws

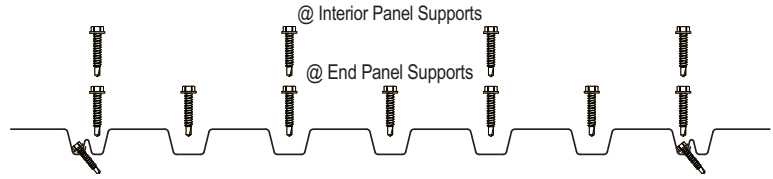

Allowable Diaphragm Shear Strength, q (plf) and Flexibility Factors, F ((in./lb)x10⁶)

DECK GAGE	SIDELAP ATTACHMENT	SPAN (ft.-in.)									
		2'-0"	3'-0"	4'-0"	5'-0"	6'-0"	7'-0"	8'-0"	9'-0"	10'-0"	
22	#10 @ 24"	q	471	421	343	318	263	257	223	224	202
		F	4.5+59R	6.2+39R	8.4+28R	8.7+22R	10.2+18R	10.1+15R	11.3+13R	11+11R	12+10R
	#10 @ 18"	q	562	421	396	364	302	291	282	250	249
		F	3.4+60R	6.2+39R	7.1+29R	7.7+23R	8.9+18R	9.1+16R	9.2+14R	10+12R	10+11R
	#10 @ 12"	q	562	486	445	405	377	357	341	328	319
		F	3.4+60R	5.3+39R	6.3+29R	6.9+23R	7.4+19R	7.7+16R	8+14R	8.2+13R	8.3+11R
	#10 @ 8"	q	643	603	539	520	476	471	444	443	424
		F	2.8+60R	4.2+40R	5.2+30R	5.6+24R	6.1+20R	6.2+17R	6.6+15R	6.6+13R	6.8+12R
	#10 @ 6"	q	717	656	623	590	567	550	537	527	519
		F	2.4+60R	3.9+40R	4.6+30R	5.1+24R	5.4+20R	5.6+17R	5.8+15R	5.9+13R	6+12R
	#10 @ 4"	q	838	791	765	739	721	707	697	689	682
		F	1.8+61R	3.2+40R	3.9+30R	4.3+24R	4.6+20R	4.8+17R	5+15R	5.1+13R	5.2+12R
20	#10 @ 24"	q	576	521	425	400	331	326	283	284	256
		F	4.8+37R	6+24R	7.8+17R	8+13R	9.3+10R	9.2+9R	10.2+7R	10+6R	10.8+5R
	#10 @ 18"	q	694	521	492	456	382	370	360	319	317
		F	3.8+37R	6+24R	6.7+18R	7.1+14R	8.2+11R	8.3+9R	8.3+8R	9.1+7R	9+6R
	#10 @ 12"	q	694	605	557	509	477	453	435	420	409
		F	3.8+37R	5.2+25R	5.9+18R	6.4+14R	6.7+12R	7+10R	7.2+9R	7.3+8R	7.5+7R
	#10 @ 8"	q	799	755	677	657	604	600	566	567	542
		F	3.3+38R	4.2+25R	5+19R	5.2+15R	5.6+12R	5.7+10R	5.9+9R	5.9+8R	6.1+7R
	#10 @ 6"	q	891	821	784	746	719	700	685	673	664
		F	2.9+38R	3.9+25R	4.4+19R	4.7+15R	4.9+12R	5.1+11R	5.2+9R	5.3+8R	5.4+7R
	#10 @ 4"	q	1041	989	960	931	911	896	884	875	868
		F	2.4+38R	3.3+25R	3.8+19R	4.1+15R	4.2+13R	4.4+11R	4.5+10R	4.5+8R	4.6+8R
18	#10 @ 24"	q	792	729	594	568	475	472	411	416	373
		F	4.7+17R	5.4+11R	6.8+7R	6.9+6R	8+4R	7.8+3R	8.7+3R	8.5+2R	9.2+2R
	#10 @ 18"	q	969	729	696	651	551	538	529	469	468
		F	3.8+18R	5.4+11R	5.8+8R	6.1+6R	7+5R	7+4R	7+3R	7.7+3R	7.6+2R
	#10 @ 12"	q	969	854	793	731	688	658	634	616	601
		F	3.8+18R	4.7+11R	5.2+8R	5.5+7R	5.8+5R	5.9+4R	6.1+4R	6.2+3R	6.3+3R
	#10 @ 8"	q	1122	1074	969	949	877	875	829	833	799
		F	3.3+18R	3.8+12R	4.4+9R	4.5+7R	4.8+6R	4.8+5R	5+4R	4.9+4R	5.1+3R
	#10 @ 6"	q	1254	1169	1123	1076	1043	1019	1001	986	975
		F	3+18R	3.6+12R	3.9+9R	4.1+7R	4.2+6R	4.3+5R	4.4+4R	4.4+4R	4.5+4R
	#10 @ 4"	q	1461	1400	1367	1333	1309	1291	1278	1267	1259
		F	2.6+19R	3.1+12R	3.3+9R	3.5+7R	3.6+6R	3.6+5R	3.7+5R	3.7+4R	3.8+4R
16	#10 @ 24"	q	1019	950	774	748	631	633	552	562	504
		F	4.3+9R	4.9+6R	6.1+3R	6.1+3R	7+2R	6.9+1R	7.6+1R	7.4+1R	8+0R
	#10 @ 18"	q	1260	950	914	862	731	719	709	635	636
		F	3.6+10R	4.9+6R	5.2+4R	5.4+3R	6.1+2R	6.1+2R	6.1+2R	6.7+1R	6.6+1R
	#10 @ 12"	q	1260	1121	1046	971	920	882	853	831	813
		F	3.6+10R	4.2+6R	4.6+4R	4.8+3R	5+3R	5.2+2R	5.3+2R	5.4+2R	5.4+1R
	#10 @ 8"	q	1466	1416	1284	1265	1175	1176	1117	1124	1081
		F	3.1+10R	3.4+7R	3.8+5R	3.9+4R	4.1+3R	4.1+3R	4.3+2R	4.3+2R	4.4+2R
	#10 @ 6"	q	1639	1540	1486	1431	1393	1366	1344	1327	1314
		F	2.8+10R	3.2+7R	3.4+5R	3.5+4R	3.6+3R	3.7+3R	3.7+2R	3.8+2R	3.8+2R
	#10 @ 4"	q	1901	1833	1796	1758	1732	1712	1697	1686	1676
		F	2.5+11R	2.8+7R	2.9+5R	3+4R	3.1+3R	3.1+3R	3.2+3R	3.2+2R	3.2+2R

See footnotes on page 28.

Type HSB®-36-SS

- 36/7 Screw Pattern at Supports
#12 or #14 SDI Recognized Screws
at Supports 0.0385" and thicker
- Sidelaps Connected with #10 Screws

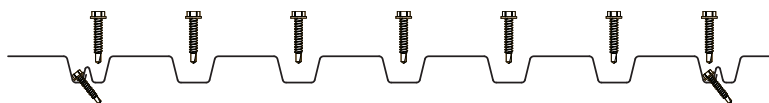

Allowable Diaphragm Shear Strength, q (plf) and Flexibility Factors, F ((in./lb)x10⁶)

DECK GAGE	SIDELAP ATTACHMENT	SPAN (ft-in.)									
		2'-0"	3'-0"	4'-0"	5'-0"	6'-0"	7'-0"	8'-0"	9'-0"	10'-0"	
22	#10 @ 24"	q	551	473	381	352	291	281	244	243	218
		F	3.7+60R	5.5+39R	7.4+29R	7.9+23R	9.3+19R	9.4+16R	10.4+13R	10.3+12R	11.2+10R
	#10 @ 18"	q	634	473	431	393	330	314	303	269	265
		F	3+60R	5.5+39R	6.5+29R	7.1+23R	8.3+19R	8.5+16R	8.7+14R	9.5+12R	9.5+11R
	#10 @ 12"	q	634	534	479	433	401	378	360	347	335
		F	3+60R	4.8+40R	5.8+30R	6.5+24R	7+20R	7.3+17R	7.6+14R	7.8+13R	8+12R
	#10 @ 8"	q	709	645	569	545	498	491	461	459	438
		F	2.5+61R	3.9+40R	5+30R	5.4+24R	5.9+20R	6.1+17R	6.4+15R	6.5+13R	6.7+12R
	#10 @ 6"	q	774	695	651	613	587	567	553	541	531
		F	2.2+61R	3.7+40R	4.5+30R	4.9+24R	5.3+20R	5.5+17R	5.7+15R	5.8+13R	5.9+12R
	#10 @ 4"	q	882	821	787	757	737	721	709	700	693
		F	1.7+61R	3.1+40R	3.8+30R	4.3+24R	4.6+20R	4.8+17R	4.9+15R	5+13R	5.1+12R
20	#10 @ 24"	q	672	582	469	437	364	354	308	306	276
		F	4.1+38R	5.4+25R	7+18R	7.3+14R	8.5+11R	8.5+10R	9.4+8R	9.3+7R	10.1+6R
	#10 @ 18"	q	780	582	534	491	415	398	385	341	337
		F	3.4+38R	5.4+25R	6.1+18R	6.6+14R	7.6+12R	7.7+10R	7.9+9R	8.6+7R	8.6+7R
	#10 @ 12"	q	780	662	597	543	505	478	457	440	427
		F	3.4+38R	4.8+25R	5.5+18R	6+15R	6.4+12R	6.7+10R	6.9+9R	7.1+8R	7.2+7R
	#10 @ 8"	q	874	804	713	687	630	622	586	585	559
		F	3+38R	4+25R	4.7+19R	5+15R	5.4+12R	5.5+11R	5.8+9R	5.8+8R	6+7R
	#10 @ 6"	q	957	866	816	772	742	720	703	689	679
		F	2.7+38R	3.7+25R	4.3+19R	4.6+15R	4.8+13R	5+11R	5.1+9R	5.2+8R	5.3+8R
	#10 @ 4"	q	1091	1023	984	951	928	911	898	888	879
		F	2.3+38R	3.2+26R	3.7+19R	4+15R	4.2+13R	4.3+11R	4.4+10R	4.5+8R	4.6+8R
18	#10 @ 24"	q	918	809	651	615	519	510	444	446	400
		F	4.1+18R	4.9+12R	6.1+8R	6.3+6R	7.2+5R	7.2+4R	8+3R	7.9+3R	8.5+2R
	#10 @ 18"	q	1079	809	751	696	590	572	559	499	494
		F	3.5+18R	4.9+12R	5.4+8R	5.7+7R	6.5+5R	6.6+4R	6.6+4R	7.2+3R	7.2+3R
	#10 @ 12"	q	1079	928	844	774	725	690	663	641	624
		F	3.5+18R	4.3+12R	4.8+9R	5.2+7R	5.5+6R	5.7+5R	5.8+4R	5.9+4R	6+3R
	#10 @ 8"	q	1217	1135	1014	986	910	903	854	855	820
		F	3.1+18R	3.6+12R	4.2+9R	4.3+7R	4.6+6R	4.6+5R	4.8+4R	4.8+4R	5+3R
	#10 @ 6"	q	1335	1224	1162	1109	1072	1044	1023	1006	993
		F	2.8+19R	3.4+12R	3.7+9R	4+7R	4.1+6R	4.2+5R	4.3+5R	4.3+4R	4.4+4R
	#10 @ 4"	q	1518	1439	1395	1356	1329	1310	1294	1282	1272
		F	2.5+19R	3+12R	3.3+9R	3.4+7R	3.5+6R	3.6+5R	3.7+5R	3.7+4R	3.7+4R
16	#10 @ 24"	q	1174	1048	845	806	682	676	593	599	537
		F	3.8+10R	4.4+6R	5.4+4R	5.6+3R	6.4+2R	6.3+2R	7+1R	6.9+1R	7.5+1R
	#10 @ 18"	q	1393	1048	982	918	779	760	746	669	666
		F	3.2+10R	4.4+6R	4.7+5R	5+4R	5.7+3R	5.7+2R	5.8+2R	6.3+1R	6.3+1R
	#10 @ 12"	q	1393	1210	1109	1024	965	921	888	862	841
		F	3.2+10R	3.9+7R	4.3+5R	4.6+4R	4.8+3R	4.9+3R	5+2R	5.1+2R	5.2+2R
	#10 @ 8"	q	1578	1487	1338	1308	1214	1209	1147	1151	1106
		F	2.9+10R	3.3+7R	3.7+5R	3.8+4R	4+3R	4+3R	4.2+2R	4.2+2R	4.3+2R
	#10 @ 6"	q	1731	1603	1531	1470	1427	1395	1370	1351	1335
		F	2.7+10R	3.1+7R	3.3+5R	3.4+4R	3.5+3R	3.6+3R	3.7+3R	3.7+2R	3.7+2R
	#10 @ 4"	q	1964	1877	1827	1785	1755	1733	1716	1702	1691
		F	2.4+11R	2.7+7R	2.9+5R	3+4R	3+3R	3.1+3R	3.1+3R	3.2+2R	3.2+2R

See footnotes on page 28.

Type HSB®-36-SS

- 36/9 Screw Pattern at Supports
#12 or #14 SDI Recognized Screws
at Supports 0.0385" and thicker
- Sidelaps Connected with #10 Screws

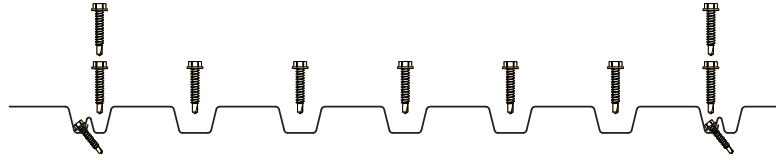

Allowable Diaphragm Shear Strength, q (plf) and Flexibility Factors, F ((in./lb)x10⁶)

DECK GAGE	SIDELAP ATTACHMENT	SPAN (ft.-in.)									
		2'-0"	3'-0"	4'-0"	5'-0"	6'-0"	7'-0"	8'-0"	9'-0"	10'-0"	
22	#10 @ 24"	q	805	668	544	480	395	368	319	309	278
		F	2.8+60R	4.7+40R	6.3+29R	7+23R	8.1+19R	8.3+16R	9.2+13R	9.3+12R	10.1+10R
	#10 @ 18"	q	881	668	593	526	434	402	378	335	325
		F	2.4+60R	4.7+40R	5.7+29R	6.4+23R	7.4+19R	7.7+16R	8+14R	8.7+12R	8.8+11R
	#10 @ 12"	q	881	727	640	565	512	469	436	413	395
		F	2.4+60R	4.2+40R	5.3+30R	6+24R	6.5+19R	6.9+17R	7.2+14R	7.4+13R	7.6+11R
	#10 @ 8"	q	950	835	729	678	612	590	549	538	510
		F	2.1+61R	3.6+40R	4.6+30R	5.1+24R	5.6+20R	5.8+17R	6.1+15R	6.2+13R	6.5+12R
	#10 @ 6"	q	1013	885	812	748	703	670	645	625	608
		F	1.9+61R	3.4+40R	4.2+30R	4.7+24R	5.1+20R	5.3+17R	5.5+15R	5.7+13R	5.8+12R
	#10 @ 4"	q	1121	1016	956	903	865	837	816	799	785
		F	1.6+61R	3+40R	3.7+30R	4.2+24R	4.5+20R	4.7+17R	4.8+15R	5+13R	5.1+12R
20	#10 @ 24"	q	976	816	664	595	491	460	399	386	347
		F	3.3+38R	4.6+25R	6+18R	6.4+14R	7.4+11R	7.6+10R	8.4+8R	8.4+7R	9.1+6R
	#10 @ 18"	q	1075	816	728	650	542	505	476	420	409
		F	2.9+38R	4.6+25R	5.4+18R	5.9+14R	6.8+12R	7+10R	7.2+9R	7.8+7R	7.9+7R
	#10 @ 12"	q	1075	892	789	701	640	593	554	523	501
		F	2.9+38R	4.2+25R	5+19R	5.5+15R	5.9+12R	6.2+10R	6.5+9R	6.7+8R	6.8+7R
	#10 @ 8"	q	1164	1032	905	847	767	743	693	682	647
		F	2.6+38R	3.7+25R	4.4+19R	4.7+15R	5.1+12R	5.3+11R	5.5+9R	5.6+8R	5.8+7R
	#10 @ 6"	q	1243	1095	1010	936	884	846	816	792	773
		F	2.4+38R	3.5+25R	4.1+19R	4.4+15R	4.7+13R	4.8+11R	5+9R	5.1+8R	5.2+7R
	#10 @ 4"	q	1379	1260	1191	1131	1089	1057	1032	1013	997
		F	2.1+38R	3.1+26R	3.6+19R	3.9+15R	4.1+13R	4.2+11R	4.4+10R	4.4+8R	4.5+8R
18	#10 @ 24"	q	1321	1118	911	827	690	655	568	554	495
		F	3.4+18R	4.2+12R	5.2+8R	5.6+6R	6.3+5R	6.4+4R	7.1+3R	7.1+3R	7.7+2R
	#10 @ 18"	q	1469	1118	1007	908	769	722	687	607	590
		F	3+18R	4.2+12R	4.7+9R	5.1+7R	5.8+5R	6+4R	6.1+4R	6.6+3R	6.7+3R
	#10 @ 12"	q	1469	1233	1100	985	905	847	802	765	733
		F	3+18R	3.9+12R	4.4+9R	4.8+7R	5+6R	5.3+5R	5.4+4R	5.6+4R	5.7+3R
	#10 @ 8"	q	1600	1439	1271	1202	1095	1068	1000	988	941
		F	2.8+18R	3.4+12R	3.9+9R	4.1+7R	4.4+6R	4.4+5R	4.6+4R	4.7+4R	4.8+3R
	#10 @ 6"	q	1715	1531	1425	1332	1267	1218	1181	1151	1127
		F	2.6+19R	3.2+12R	3.6+9R	3.8+7R	3.9+6R	4.1+5R	4.1+4R	4.2+4R	4.3+4R
	#10 @ 4"	q	1906	1764	1681	1609	1557	1519	1489	1466	1446
		F	2.4+19R	2.9+12R	3.2+9R	3.3+7R	3.5+6R	3.5+5R	3.6+5R	3.7+4R	3.7+4R
16	#10 @ 24"	q	1675	1434	1169	1071	903	864	751	737	659
		F	3.1+10R	3.8+6R	4.6+4R	4.9+3R	5.5+2R	5.6+2R	6.2+1R	6.2+1R	6.7+1R
	#10 @ 18"	q	1878	1434	1302	1182	1004	956	917	811	792
		F	2.8+10R	3.8+6R	4.2+5R	4.5+4R	5.1+3R	5.2+2R	5.3+2R	5.7+1R	5.8+1R
	#10 @ 12"	q	1878	1592	1429	1289	1191	1119	1064	1020	985
		F	2.8+10R	3.5+7R	3.9+5R	4.2+4R	4.4+3R	4.6+2R	4.7+2R	4.8+2R	4.9+2R
	#10 @ 8"	q	2055	1870	1661	1583	1449	1419	1334	1323	1262
		F	2.6+10R	3+7R	3.4+5R	3.6+4R	3.8+3R	3.8+3R	4+2R	4+2R	4.1+2R
	#10 @ 6"	q	2208	1991	1866	1756	1679	1621	1577	1541	1513
		F	2.5+10R	2.9+7R	3.1+5R	3.3+4R	3.4+3R	3.5+3R	3.6+2R	3.6+2R	3.7+2R
	#10 @ 4"	q	2455	2293	2199	2117	2058	2014	1980	1953	1931
		F	2.2+11R	2.6+7R	2.8+5R	2.9+4R	3+3R	3+3R	3.1+3R	3.1+2R	3.1+2R

See footnotes on page 28.

Type HSB®-36-SS

- 36/4 Weld Pattern at Supports
- Sidelaps Connected with #10 Screws



Allowable Diaphragm Shear Strength, q (plf) and Flexibility Factors, F ((in./lb)x10⁶)

DECK GAGE	SIDELAP ATTACHMENT	SPAN (ft.-in.)									
		4'-0"	5'-0"	6'-0"	7'-0"	8'-0"	9'-0"	10'-0"	11'-0"	12'-0"	
22	#10 @ 24"	q	344	308	252	240	206	204	183		
		F	-6.5+270R	-3.2+216R	0.2+179R	1.6+154R	3.8+134R	4.4+119R	6+107R		
	#10 @ 18"	q	393	347	285	268	255	226	223		
		F	-7.8+271R	-4.3+216R	-1+180R	0.5+154R	1.7+135R	3.4+120R	4+108R		
	#10 @ 12"	q	442	386	350	323	304	291	281		
		F	-8.6+271R	-5+217R	-2.6+180R	-0.8+155R	0.5+135R	1.5+120R	2.3+108R		
	#10 @ 8"	q	524	496	448	435	402	399	379		
		F	-9.6+271R	-6.3+217R	-3.8+181R	-2.3+155R	-0.9+136R	0+120R	0.9+108R		
	#10 @ 6"	q	597	557	529	508	492	480	470		
		F	-10.2+271R	-6.8+217R	-4.5+181R	-2.9+155R	-1.6+136R	-0.7+121R	0.1+109R		
	#10 @ 4"	q	726	692	668	651	638	627	619		
		F	-10.9+272R	-7.5+217R	-5.3+181R	-3.7+155R	-2.5+136R	-1.5+121R	-0.8+109R		
20	#10 @ 24"	q	480	429	352	334	288	281	252	253	232
		F	-1.6+170R	0.5+136R	3+113R	3.8+97R	5.4+84R	5.7+75R	7+67R	7+61R	8+56R
	#10 @ 18"	q	544	480	395	371	352	309	304	300	275
		F	-2.8+171R	-0.5+137R	1.8+113R	2.8+97R	3.6+85R	4.8+75R	5.2+68R	5.5+62R	6.4+56R
	#10 @ 12"	q	601	532	481	444	417	395	381	370	361
		F	-3.5+171R	-1.1+137R	0.4+114R	1.6+98R	2.5+85R	3.1+76R	3.7+68R	4.1+62R	4.5+57R
	#10 @ 8"	q	703	663	602	587	545	538	510	510	489
		F	-4.4+172R	-2.3+137R	-0.7+114R	0.3+98R	1.2+86R	1.7+76R	2.3+69R	2.7+62R	3.1+57R
	#10 @ 6"	q	797	742	703	675	654	637	623	612	602
		F	-5+172R	-2.8+137R	-1.3+114R	-0.3+98R	0.5+86R	1.1+76R	1.6+69R	2+62R	2.4+57R
	#10 @ 4"	q	960	914	883	859	841	827	815	806	798
		F	-5.6+172R	-3.5+137R	-2+115R	-1+98R	-0.2+86R	0.4+76R	0.8+69R	1.2+62R	1.6+57R
18	#10 @ 24"	q	807	720	594	560	485	471	420	416	381
		F	2.2+83R	3.2+66R	4.8+55R	5.1+47R	6.3+41R	6.3+36R	7.3+32R	7.2+29R	7.9+27R
	#10 @ 18"	q	890	797	660	616	584	515	499	488	447
		F	1.2+83R	2.4+66R	3.9+55R	4.3+47R	4.7+41R	5.6+36R	5.7+33R	5.8+30R	6.5+27R
	#10 @ 12"	q	970	864	790	729	683	647	618	596	579
		F	0.6+83R	1.8+67R	2.7+55R	3.3+47R	3.7+42R	4.1+37R	4.4+33R	4.6+30R	4.8+28R
	#10 @ 8"	q	1121	1053	954	927	866	854	810	806	773
		F	-0.2+84R	0.8+67R	1.7+56R	2.1+48R	2.6+42R	2.9+37R	3.2+33R	3.4+30R	3.6+28R
	#10 @ 6"	q	1259	1169	1107	1060	1025	996	974	955	939
		F	-0.7+84R	0.4+67R	1.1+56R	1.6+48R	2+42R	2.4+37R	2.6+33R	2.8+30R	3+28R
	#10 @ 4"	q	1497	1424	1372	1334	1304	1281	1262	1246	1233
		F	-1.3+84R	-0.2+67R	0.5+56R	1+48R	1.4+42R	1.7+37R	1.9+34R	2.1+31R	2.3+28R
16	#10 @ 24"	q	1033	939	775	737	639	625	558	554	505
		F	3.4+47R	4+37R	5.2+31R	5.3+26R	6.2+23R	6.2+20R	6.9+18R	6.8+16R	7.4+15R
	#10 @ 18"	q	1149	1036	867	816	778	687	669	654	597
		F	2.5+47R	3.2+38R	4.3+31R	4.6+27R	4.8+23R	5.5+21R	5.5+18R	5.6+17R	6.1+15R
	#10 @ 12"	q	1259	1129	1038	971	916	871	835	805	782
		F	1.9+47R	2.7+38R	3.2+31R	3.6+27R	3.9+24R	4.2+21R	4.3+19R	4.5+17R	4.6+16R
	#10 @ 8"	q	1466	1388	1264	1234	1156	1144	1088	1085	1043
		F	1.2+48R	1.8+38R	2.4+32R	2.6+27R	3+24R	3.1+21R	3.3+19R	3.4+17R	3.6+16R
	#10 @ 6"	q	1653	1545	1470	1414	1372	1338	1310	1287	1268
		F	0.8+48R	1.4+38R	1.9+32R	2.2+27R	2.4+24R	2.6+21R	2.8+19R	2.9+17R	3+16R
	#10 @ 4"	q	1968	1883	1823	1778	1744	1716	1694	1675	1660
		F	0.3+48R	0.9+38R	1.3+32R	1.6+27R	1.8+24R	2+21R	2.2+19R	2.3+17R	2.4+16R

See footnotes on page 28.

Type HSB[®]-36-SS

- 36/5 Weld Pattern at Supports
- Sidelaps Connected with #10 Screws



Allowable Diaphragm Shear Strength, q (plf) and Flexibility Factors, F ((in./lb)x10⁶)

DECK GAGE	SIDELAP ATTACHMENT	SPAN (ft.-in.)									
		4'-0"	5'-0"	6'-0"	7'-0"	8'-0"	9'-0"	10'-0"	11'-0"	12'-0"	
22	#10 @ 24"	q	431	378	310	289	249	242	218		
		F	-2.3+190R	0.2+152R	2.9+126R	3.9+108R	5.6+94R	6.1+83R	7.4+75R		
	#10 @ 18"	q	480	417	343	317	298	264	257		
		F	-3.3+190R	-0.7+152R	1.8+126R	3+108R	3.8+95R	5.2+84R	5.7+75R		
	#10 @ 12"	q	527	456	408	373	347	329	316		
		F	-4+190R	-1.3+152R	0.5+127R	1.8+109R	2.8+95R	3.5+84R	4.1+76R		
	#10 @ 8"	q	607	565	506	485	445	438	414		
		F	-4.8+191R	-2.5+153R	-0.6+127R	0.4+109R	1.5+95R	2.1+85R	2.8+76R		
	#10 @ 6"	q	682	627	589	561	539	522	509		
		F	-5.4+191R	-2.9+153R	-1.3+127R	-0.1+109R	0.8+95R	1.5+85R	2+76R		
	#10 @ 4"	q	817	769	736	712	693	678	666		
		F	-6+191R	-3.6+153R	-2+127R	-0.9+109R	0+96R	0.7+85R	1.2+76R		
20	#10 @ 24"	q	601	526	433	403	349	335	301	297	272
		F	0.9+120R	2.5+95R	4.5+79R	5.1+68R	6.5+59R	6.7+52R	7.7+47R	7.8+43R	8.6+39R
	#10 @ 18"	q	662	577	476	440	413	363	352	344	315
		F	0+120R	1.7+96R	3.5+79R	4.3+68R	4.8+60R	5.9+53R	6.2+47R	6.4+43R	7.1+39R
	#10 @ 12"	q	716	629	561	513	477	449	430	414	401
		F	-0.6+120R	1.1+96R	2.3+80R	3.2+68R	3.8+60R	4.3+53R	4.8+48R	5.1+43R	5.4+40R
	#10 @ 8"	q	820	760	683	658	606	592	558	554	530
		F	-1.5+121R	0+96R	1.3+80R	2+69R	2.7+60R	3+54R	3.5+48R	3.7+44R	4.1+40R
	#10 @ 6"	q	916	841	788	750	720	697	678	662	649
		F	-2+121R	-0.4+97R	0.7+80R	1.4+69R	2+60R	2.5+54R	2.8+48R	3.1+44R	3.4+40R
	#10 @ 4"	q	1089	1024	979	945	920	899	883	869	857
		F	-2.5+121R	-1+97R	0+81R	0.8+69R	1.3+60R	1.7+54R	2.1+48R	2.4+44R	2.6+40R
18	#10 @ 24"	q	1002	885	731	677	588	562	502	491	450
		F	3.2+58R	4+46R	5.4+38R	5.6+33R	6.6+28R	6.6+25R	7.4+22R	7.4+20R	8+18R
	#10 @ 18"	q	1085	956	797	734	687	606	581	563	516
		F	2.4+58R	3.3+46R	4.5+38R	4.9+33R	5.2+29R	6+25R	6.1+23R	6.2+21R	6.7+19R
	#10 @ 12"	q	1166	1024	925	847	786	738	700	670	647
		F	1.9+58R	2.8+47R	3.5+39R	4+33R	4.3+29R	4.6+26R	4.9+23R	5.1+21R	5.2+19R
	#10 @ 8"	q	1321	1219	1094	1049	973	951	898	886	845
		F	1.1+59R	1.9+47R	2.6+39R	2.9+34R	3.3+29R	3.5+26R	3.8+23R	3.9+21R	4.1+19R
	#10 @ 6"	q	1465	1340	1253	1189	1139	1100	1068	1042	1020
		F	0.7+59R	1.5+47R	2.1+39R	2.5+34R	2.8+29R	3+26R	3.2+24R	3.3+21R	3.4+20R
	#10 @ 4"	q	1721	1615	1540	1484	1441	1407	1379	1356	1337
		F	0.2+59R	1+47R	1.5+39R	1.9+34R	2.1+30R	2.4+26R	2.5+24R	2.7+21R	2.8+20R
16	#10 @ 24"	q	1277	1139	946	884	768	739	661	647	590
		F	3.8+33R	4.3+26R	5.3+21R	5.4+18R	6.2+16R	6.2+14R	6.9+12R	6.8+11R	7.3+10R
	#10 @ 18"	q	1393	1235	1038	963	906	801	771	748	683
		F	3.1+33R	3.7+26R	4.6+22R	4.8+18R	5+16R	5.6+14R	5.7+13R	5.7+12R	6.2+10R
	#10 @ 12"	q	1505	1330	1208	1118	1044	985	937	899	867
		F	2.6+33R	3.2+26R	3.6+22R	4+19R	4.2+16R	4.4+15R	4.6+13R	4.7+12R	4.8+11R
	#10 @ 8"	q	1717	1597	1440	1389	1292	1268	1200	1188	1138
		F	2+33R	2.4+27R	2.9+22R	3+19R	3.3+17R	3.4+15R	3.6+13R	3.6+12R	3.8+11R
	#10 @ 6"	q	1914	1763	1658	1580	1520	1472	1433	1402	1375
		F	1.6+34R	2.1+27R	2.4+22R	2.6+19R	2.8+17R	2.9+15R	3.1+13R	3.2+12R	3.2+11R
	#10 @ 4"	q	2258	2132	2043	1977	1926	1886	1853	1825	1802
		F	1.1+34R	1.6+27R	1.9+22R	2.1+19R	2.3+17R	2.4+15R	2.5+13R	2.6+12R	2.6+11R

See footnotes on page 28.

Type HSB®-36-SS

- 36/7/4 Weld Pattern at Supports
- Sidelaps Connected with #10 Screws

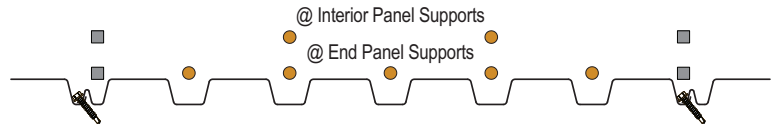

Allowable Diaphragm Shear Strength, q (plf) and Flexibility Factors, F ((in./lb)x10⁶)

DECK GAGE	SIDELAP ATTACHMENT	SPAN (ft.-in.)									
		4'-0"	5'-0"	6'-0"	7'-0"	8'-0"	9'-0"	10'-0"	11'-0"	12'-0"	
22	#10 @ 24"	q	402	355	291	273	235	230	207		
		F	8+28R	8.4+22R	9.8+18R	9.8+15R	10.9+12R	10.8+11R	11.7+10R		
	#10 @ 18"	q	451	394	323	301	284	251	246		
		F	6.9+29R	7.5+23R	8.7+18R	8.9+16R	9+14R	9.8+12R	9.8+10R		
	#10 @ 12"	q	500	433	388	357	333	317	304		
		F	6.1+29R	6.8+23R	7.2+19R	7.6+16R	7.8+14R	8.1+12R	8.2+11R		
	#10 @ 8"	q	597	550	486	468	431	425	402		
		F	5.1+30R	5.5+24R	6+20R	6.2+17R	6.5+15R	6.6+13R	6.8+12R		
	#10 @ 6"	q	686	628	584	552	528	512	500		
		F	4.6+30R	5+24R	5.4+20R	5.6+17R	5.8+15R	5.9+13R	6+12R		
	#10 @ 4"	q	845	792	756	730	710	695	682		
		F	3.9+30R	4.3+24R	4.6+20R	4.8+17R	5+15R	5.1+13R	5.2+12R		
20	#10 @ 24"	q	561	494	406	380	328	317	285	282	259
		F	7.5+17R	7.8+13R	9+10R	8.9+9R	9.9+7R	9.7+6R	10.6+5R	10.3+5R	11+4R
	#10 @ 18"	q	625	545	449	417	393	345	336	329	302
		F	6.5+18R	6.9+14R	7.9+11R	8.1+9R	8.2+8R	8.9+7R	8.9+6R	8.9+6R	9.4+5R
	#10 @ 12"	q	689	596	534	490	457	431	413	399	387
		F	5.8+18R	6.3+14R	6.6+12R	6.9+10R	7.1+9R	7.3+8R	7.4+7R	7.5+6R	7.6+6R
	#10 @ 8"	q	814	751	663	637	586	574	542	540	516
		F	4.9+19R	5.1+15R	5.5+12R	5.6+10R	5.9+9R	5.9+8R	6.1+7R	6.1+7R	6.2+6R
	#10 @ 6"	q	925	846	791	748	714	689	671	657	645
		F	4.4+19R	4.7+15R	4.9+12R	5.1+11R	5.2+9R	5.3+8R	5.4+7R	5.4+7R	5.5+6R
	#10 @ 4"	q	1132	1060	1010	974	946	924	907	892	880
		F	3.8+19R	4+15R	4.2+13R	4.4+11R	4.5+9R	4.5+8R	4.6+8R	4.7+7R	4.7+6R
18	#10 @ 24"	q	948	830	685	638	554	532	475	466	427
		F	6.5+7R	6.7+6R	7.7+4R	7.6+3R	8.4+3R	8.2+2R	8.9+2R	8.7+2R	9.3+1R
	#10 @ 18"	q	1047	909	751	695	652	576	554	538	493
		F	5.7+8R	5.9+6R	6.8+5R	6.9+4R	6.9+3R	7.5+3R	7.5+2R	7.4+2R	7.9+2R
	#10 @ 12"	q	1144	988	883	808	751	707	672	645	625
		F	5.1+8R	5.4+6R	5.6+5R	5.8+4R	6+4R	6.1+3R	6.2+3R	6.3+3R	6.3+2R
	#10 @ 8"	q	1319	1215	1080	1034	949	927	870	861	822
		F	4.3+9R	4.4+7R	4.7+6R	4.7+5R	4.9+4R	4.9+4R	5.1+3R	5+3R	5.1+3R
	#10 @ 6"	q	1488	1354	1262	1195	1145	1103	1068	1041	1020
		F	3.8+9R	4+7R	4.2+6R	4.3+5R	4.3+4R	4.4+4R	4.4+4R	4.5+3R	4.5+3R
	#10 @ 4"	q	1804	1681	1597	1535	1489	1452	1422	1398	1377
		F	3.3+9R	3.5+7R	3.6+6R	3.6+5R	3.7+5R	3.7+4R	3.8+4R	3.8+3R	3.8+3R
16	#10 @ 24"	q	1217	1076	889	835	725	701	627	616	562
		F	5.8+4R	5.9+3R	6.8+2R	6.7+1R	7.4+1R	7.2+1R	7.8+0R	7.6+0R	8.1+0R
	#10 @ 18"	q	1355	1186	981	914	863	763	737	717	654
		F	5+4R	5.2+3R	6+2R	6+2R	6+1R	6.6+1R	6.5+1R	6.5+1R	6.9+1R
	#10 @ 12"	q	1482	1297	1166	1072	1002	947	903	867	839
		F	4.5+4R	4.7+3R	4.9+3R	5.1+2R	5.2+2R	5.3+2R	5.4+1R	5.4+1R	5.5+1R
	#10 @ 8"	q	1725	1602	1436	1387	1278	1254	1180	1169	1115
		F	3.8+5R	3.9+4R	4.1+3R	4.1+3R	4.2+2R	4.2+2R	4.3+2R	4.3+2R	4.4+1R
	#10 @ 6"	q	1957	1793	1680	1598	1536	1488	1448	1416	1389
		F	3.4+5R	3.5+4R	3.6+3R	3.7+3R	3.7+2R	3.8+2R	3.8+2R	3.8+2R	3.8+2R
	#10 @ 4"	q	2388	2240	2138	2063	2007	1962	1926	1897	1872
		F	2.9+5R	3+4R	3.1+3R	3.1+3R	3.2+3R	3.2+2R	3.2+2R	3.2+2R	3.2+2R

See footnotes on page 28.

Type HSB®-36-SS

- 36/7 Weld Pattern at Supports
- Sidelaps Connected with #10 Screws



Allowable Diaphragm Shear Strength, q (plf) and Flexibility Factors, F ((in./lb)x10⁶)

DECK GAGE	SIDELAP ATTACHMENT	SPAN (ft.-in.)									
		4'-0"	5'-0"	6'-0"	7'-0"	8'-0"	9'-0"	10'-0"	11'-0"	12'-0"	
22	#10 @ 24"	q	460	401	329	306	264	255	230		
		F	7.1+29R	7.6+23R	8.9+19R	9.1+16R	10.1+13R	10+12R	10.9+10R		
	#10 @ 18"	q	509	440	362	334	313	277	269		
		F	6.3+29R	6.9+23R	8+19R	8.3+16R	8.5+14R	9.3+12R	9.3+11R		
	#10 @ 12"	q	558	479	427	390	362	342	328		
		F	5.7+30R	6.4+24R	6.8+19R	7.2+17R	7.5+14R	7.7+13R	7.9+11R		
	#10 @ 8"	q	652	597	525	502	460	451	425		
		F	4.9+30R	5.3+24R	5.8+20R	6+17R	6.3+15R	6.4+13R	6.6+12R		
	#10 @ 6"	q	735	669	623	585	557	538	523		
		F	4.4+30R	4.9+24R	5.2+20R	5.5+17R	5.6+15R	5.8+13R	5.9+12R		
	#10 @ 4"	q	889	829	788	757	734	716	702		
		F	3.8+30R	4.2+24R	4.5+20R	4.7+17R	4.9+15R	5+13R	5.1+12R		
20	#10 @ 24"	q	642	558	460	426	369	353	317	312	286
		F	6.7+18R	7.1+14R	8.1+11R	8.2+10R	9.1+8R	9.1+7R	9.8+6R	9.7+6R	10.3+5R
	#10 @ 18"	q	706	610	503	463	433	381	369	358	329
		F	5.9+18R	6.4+14R	7.3+12R	7.5+10R	7.7+9R	8.4+7R	8.4+7R	8.4+6R	9+5R
	#10 @ 12"	q	770	661	588	536	497	467	446	429	414
		F	5.4+18R	5.9+15R	6.3+12R	6.6+10R	6.8+9R	7+8R	7.1+7R	7.2+6R	7.3+6R
	#10 @ 8"	q	884	812	717	683	626	610	574	569	543
		F	4.7+19R	4.9+15R	5.3+12R	5.4+11R	5.7+9R	5.7+8R	5.9+7R	5.9+7R	6.1+6R
	#10 @ 6"	q	992	901	839	793	755	724	703	686	672
		F	4.2+19R	4.5+15R	4.8+13R	5+11R	5.1+9R	5.2+8R	5.3+8R	5.3+7R	5.4+6R
	#10 @ 4"	q	1193	1110	1053	1011	979	954	934	917	903
		F	3.7+19R	4+15R	4.2+13R	4.3+11R	4.4+10R	4.5+8R	4.6+8R	4.6+7R	4.7+6R
18	#10 @ 24"	q	1085	939	776	716	622	593	530	516	473
		F	5.8+8R	6.1+6R	7+5R	7+4R	7.7+3R	7.7+3R	8.3+2R	8.1+2R	8.7+2R
	#10 @ 18"	q	1178	1018	842	773	721	637	609	588	539
		F	5.2+8R	5.5+7R	6.3+5R	6.4+4R	6.5+4R	7+3R	7.1+3R	7.1+3R	7.5+2R
	#10 @ 12"	q	1266	1098	974	886	820	768	727	695	670
		F	4.7+9R	5.1+7R	5.3+6R	5.5+5R	5.7+4R	5.8+4R	5.9+3R	6+3R	6.1+3R
	#10 @ 8"	q	1437	1312	1167	1112	1018	988	925	911	868
		F	4.1+9R	4.2+7R	4.5+6R	4.6+5R	4.8+4R	4.8+4R	4.9+3R	4.9+3R	5+3R
	#10 @ 6"	q	1600	1447	1342	1265	1206	1160	1123	1091	1066
		F	3.7+9R	3.9+7R	4+6R	4.2+5R	4.2+4R	4.3+4R	4.4+4R	4.4+3R	4.4+3R
	#10 @ 4"	q	1906	1767	1670	1599	1545	1503	1468	1440	1394
		F	3.2+9R	3.4+7R	3.5+6R	3.6+5R	3.6+5R	3.7+4R	3.7+4R	3.8+3R	3.8+3R
16	#10 @ 24"	q	1387	1212	1003	933	811	777	695	678	619
		F	5.2+4R	5.4+3R	6.1+2R	6.1+2R	6.8+1R	6.7+1R	7.2+1R	7.1+1R	7.6+1R
	#10 @ 18"	q	1511	1323	1095	1012	949	839	806	779	711
		F	4.6+5R	4.8+3R	5.5+3R	5.6+2R	5.6+2R	6.1+1R	6.1+1R	6.1+1R	6.5+1R
	#10 @ 12"	q	1633	1428	1280	1170	1087	1023	972	930	896
		F	4.2+5R	4.4+4R	4.7+3R	4.8+2R	4.9+2R	5.1+2R	5.1+2R	5.2+1R	5.3+1R
	#10 @ 8"	q	1869	1721	1538	1475	1364	1330	1248	1231	1172
		F	3.6+5R	3.7+4R	3.9+3R	4+3R	4.1+2R	4.1+2R	4.2+2R	4.2+2R	4.3+2R
	#10 @ 6"	q	2095	1907	1778	1684	1612	1555	1510	1472	1441
		F	3.2+5R	3.4+4R	3.5+3R	3.6+3R	3.6+2R	3.7+2R	3.7+2R	3.8+2R	3.8+2R
	#10 @ 4"	q	2511	2343	2226	2141	2076	2024	1982	1948	1919
		F	2.8+5R	2.9+4R	3+3R	3.1+3R	3.1+3R	3.1+2R	3.2+2R	3.2+2R	3.2+2R

See footnotes on page 28.

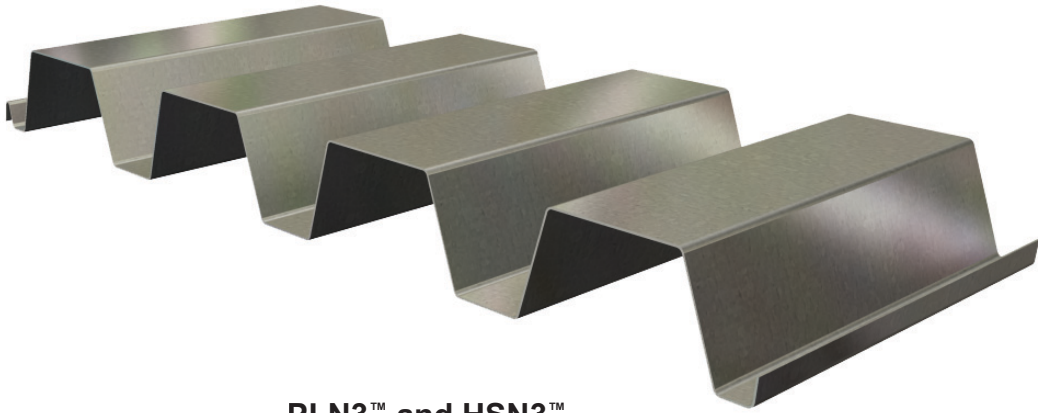

PLN3™ and HSN3™

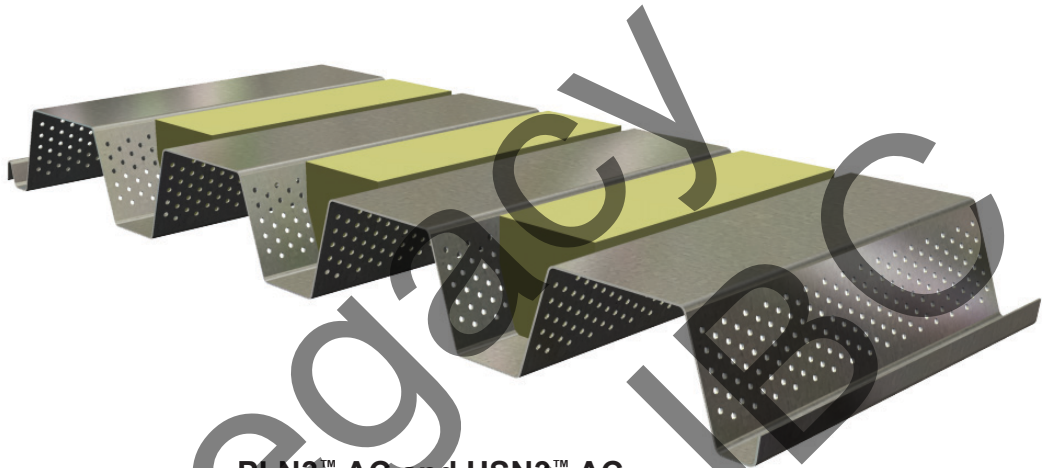

PLN3™ AC and HSN3™ AC

PLN3™ AND HSN3™ DECK CONTENTS

Section Properties	80
Vertical Load Capacity	83
PLN3™ Allowable Diaphragm Shear Strength and Flexibility Tables	84-97
PLN3 with Welds	84
PLN3 with Hilti fasteners	85-87
PLN3 with Pneutek fasteners	88-95
PLN3 with Screws	96-97
HSN3™ Allowable Diaphragm Shear Strength and Flexibility Tables	98-101
HSN3 with Welds	98
HSN3 with Screws	99-100
HSN3-NS with Welds	101
Acoustical Properties	155

Type PLN3™ or HSN3™

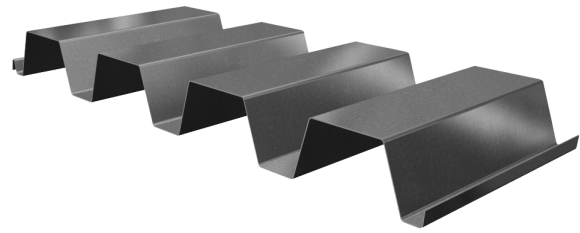

- 3" Deep Roof Deck
- Primer Painted or Galvanized
- PLN3 Deck used with PunchLok II System
- HSN3 Deck used with TSWs, BPs or Screws

Dimensions

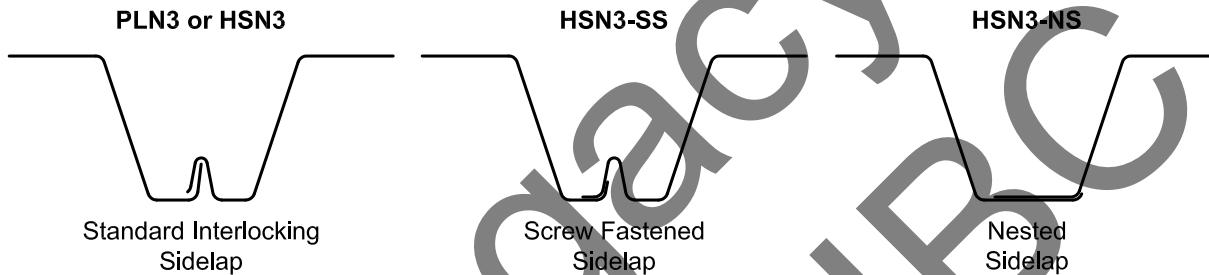
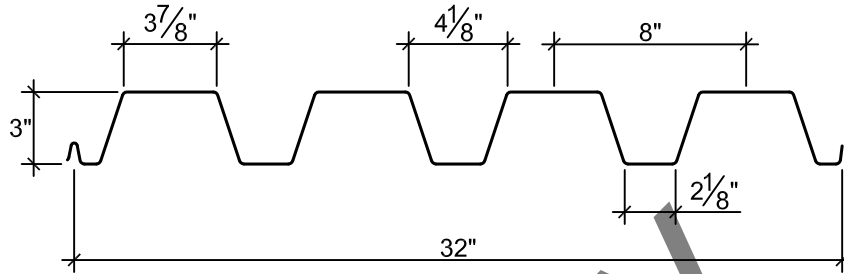

Deck Weight and Section Properties

Gage	Weight		I_d for Deflection				Moment		Allowable Reactions per ft of Width (lb)							
	Galv (psf)	Painted (psf)	Single Span (in. ⁴ /ft)	Multi Span (in. ⁴ /ft)	+ S_{eff} (in. ³ /ft)	- S_{eff} (in. ³ /ft)	One Flange Loading			Two Flange Loading						
							End Bearing Length			Interior Bearing Length		End Bearing Length			Interior Bearing Length	
						2"	3"	4"	4"	8"	2"	3"	4"	4"	8"	
22	2.0	1.9	0.721	0.785	0.353	0.405	618	711	789	1240	1447	579	648	706	1448	1708
20	2.4	2.3	0.889	0.953	0.452	0.509	870	997	1105	1738	2154	871	971	1056	2066	2597
18	3.1	3.1	1.229	1.273	0.671	0.722	1481	1687	1860	2941	3682	1624	1797	1943	3574	4548
16	3.9	3.8	1.571	1.587	0.883	0.932	2240	2538	2789	4430	5497	2611	2873	3094	5458	6887

- Notes:**
1. Section properties are based on $F_y = 50,000$ psi.
 2. I_d is for deflection due to uniform loads.
 3. S_{eff} (+ or -) is the effective section modulus.
 4. Multiply tabulated deck values listed above by the following adjustment factors to obtain acoustical deck section properties:

Deck Type	I_d for Deflection		Moment		Allowable Reactions per ft of Width (lb) for One Flange Loading (lb)	
	Single Span	Multi Span	+ S_{eff}	- S_{eff}	End Bearing	Interior Bearing
N3 - Acoustical	0.93	0.94	0.91	0.92	1.00	0.85

5. Allowable (ASD) reactions are based on web crippling, per AISI S100 Section C3.4, where $\Omega_w = 1.70$ for end bearing and 1.75 for interior bearing. Nominal reactions may be determined by multiplying the table values by Ω_w . LRFD reactions may be determined by multiplying nominal reactions by $\Phi_w = 0.90$ for end reactions and 0.85 for interior reactions.

Type PLN3™ or HSN3™



Attachment Patterns to Supports

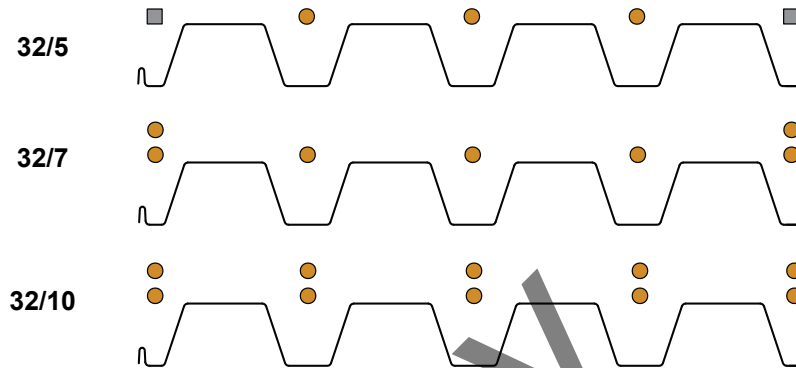

Note: ● indicates location of arc spot weld, power actuated fastener, or screw as indicated in the load tables.
■ indicates location of arc seam weld, power actuated fastener, or screw as indicated in the load tables.

Footnotes for Allowable Uniform Load Tables

1. Stress = Allowable uniform load based on maximum allowable flexural stress in deck.
2. L/360, L/240 or L/180 = Uniform load which produces selected deflection in deck.
3. The symbol ♦♦ indicates allowable uniform load based on deflection exceeds allowable uniform load based on stress.
4. Nominal uniform loads governed by stress may be determined by multiplying the allowable values in the table by $\Omega_b = 1.67$. LRFD loads may be determined by multiplying nominal loads by $\Phi_b = 0.95$.

LESLIE BROS
2015

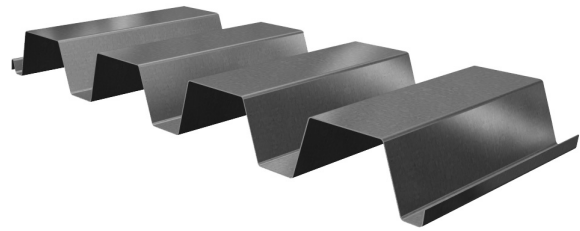

Footnotes for Diaphragm Shear Strength and Flexibility Factor Tables

General Notes

1. VSC2 = Verco Sidelap Connection 2; BP = Button Punch; TSW = Top Seam Weld; #10 = #10 Generic Screw. Sidelap connections are not required at support locations.
2. The dimension from the first and last sidelap connection within each span is to be no more than one-half of specified spacing.
3. R is the ratio of vertical span (L_V) of the deck to the length (L_S) of the deck sheet: $R = L_V / L_S$.
4. Interpolation of diaphragm shear strength between adjacent spans or sidelap spacings is permissible. For interpolation of the diaphragm flexibility factor between adjacent spans, use the flexibility factor for the closest adjacent span length.
5. Diaphragm shear values for side seam fasteners placed at spacings other than those in the table should be determined based on the number of fasteners in each span.
6. For web perforated acoustical deck profiles, modify tabulated q and F values using the following adjustment factors:

Deck Type	R_q	R_F
N3 - Acoustical	0.93	1.07

Note: Adjustment Factor, R_q must be applied only to allowable diaphragm shear strengths governed by panel buckling which are shown in the shaded areas of the diaphragm tables.

Notes Specific to Tables using Welds to Supports

1. The allowable diaphragm shear values in the table utilize a factor of safety, $\Omega = 3.0$ (limited by connections) with the exception of the gray shaded table values, which utilize a factor of safety of $\Omega = 2.0$ (limited by panel buckling).
2. A 1" x 3/8" effective arc seam weld is required at supports adjacent to sidelap and a 1/2" effective diameter arc spot welds are required at supports in interior flutes.

Notes Specific to Tables using Hilti or Pneutek Fasteners to Supports

1. X-EDNK22 = Hilti EDNK22 THQ12 fastener; X-ENP-19 = Hilti X-ENP-19 L15 fastener; K66 = Pneutek K66062 or K66075 fasteners; K64 = Pneutek K64062 fastener; SDK63 = Pneutek SDK63075; SDK61 = Pneutek SDK61075
2. The allowable diaphragm shear values in the table utilize a factor of safety, $\Omega = 2.5$ (limited by connections) with the exception of the shaded table values, which utilize a factor of safety of $\Omega = 2.0$ (limited by panel buckling).

Notes Specific to Tables using Screws to Supports

1. The allowable diaphragm shear values in the table utilize a factor of safety, $\Omega = 2.5$ (limited by connections) with the exception of the shaded table values, which utilize a factor of safety of $\Omega = 2.0$ (limited by panel buckling).
2. Deck is attached with minimum #12 Screws (self drilling, self tapping) to supports. Select appropriate screw based on actual substrate thickness. This table is provided as a guide, proper selection should be verified based on the specific fasteners used.

Support Thickness	Fastener Designation
33 mil (0.0346") to 3/16"	#3 Drill Point
1/8" to 1/4"	#4 Drill Point
1/8" to 1/2"	#5 Drill Point

3. All tabulated diaphragm values shown in this section are for a minimum 0.0385 in. thick support with SDI recognized screws produced by Buildex, Elco, Hilti or Simpson Strong-Tie. If the minimum support thickness can not be met or a screw that is not recognized by SDI is used, modify tabulated q and F values based on actual substrate and thickness using Adjustment Factors listed in this table.

Substrate Thickness and Strength

Deck Gage	Factors	Substrate Thickness and Strength									
		20 ga		18 ga		16 ga		14 ga		≥ 12 ga	
		33 mil (0.0345 in)	50 ksi	43 mil (0.0451 in)	50 ksi	54 mil (0.0566 in)	50 ksi	68 mil (0.0713 in)	50 ksi	≥ 97 mil (0.1017 in)	50 ksi
22	R_q	0.44	0.61	0.67	0.78	0.78	0.78	0.78	0.78	0.78	0.78
	R_F	1.28	1.25	1.17	1.00	1.00	1.00	1.00	1.00	1.00	1.00
20	R_q	0.34	0.49	0.54	0.74	0.74	0.78	0.78	0.78	0.78	0.78
	R_F	1.31	1.31	1.24	1.19	1.15	1.00	1.00	1.00	1.00	1.00
18	R_q	0.26	0.37	0.38	0.55	0.55	0.78	0.76	0.78	0.78	0.78
	R_F	1.34	1.39	1.30	1.31	1.26	1.18	1.19	1.00	1.00	1.00
16	R_q	0.20	0.30	0.30	0.44	0.43	0.65	0.61	0.78	0.78	0.78
	R_F	1.43	1.66	1.39	1.54	1.33	1.34	1.25	1.00	1.00	1.00

4. Adjustment factors are based on connection strengths determined in accordance with Section E4 of AISI S100. These self drilling, self tapping screws must be compliant with ASTM C1315.
5. Allowable Diaphragm Strength = $q \cdot R_q$; Flexibility Factor = $F \cdot R_F$.
6. These adjustment factors are based on the maximum adjustment for the tabulated span lengths and fastener patterns. To calculate a specific condition, use design equations listed at the end of Evaluation Report ER-0217.

Type PLN3™ or HSN3™



Allowable Uniform Loads (psf)

DECK			SPAN (ft.-in.)																
SPAN	GAGE	CRITERIA	4'-0"	5'-0"	6'-0"	7'-0"	8'-0"	9'-0"	10'-0"	11'-0"	12'-0"	13'-0"	14'-0"	15'-0"	16'-0"	17'-0"	18'-0"	19'-0"	20'-0"
SINGLE	22	Stress	300	282	196	144	110	87	71	58	49	42	36	31	28	24	22	20	18
		L/360	◆◆◆	252	146	92	62	43	32	24	18	14	12	9	8	6	5	5	4
		L/240	◆◆◆	◆◆◆	◆◆◆	138	92	65	47	36	27	22	17	14	12	10	8	7	6
	20	L/180	◆◆◆	◆◆◆	◆◆◆	◆◆◆	◆◆◆	87	63	47	37	29	23	19	15	13	11	9	8
		Stress	300	300	251	184	141	112	90	75	63	53	46	40	35	31	28	25	23
		L/360	◆◆◆	◆◆◆	180	113	76	53	39	29	23	18	14	12	10	8	7	6	5
	18	L/240	◆◆◆	◆◆◆	◆◆◆	170	114	80	58	44	34	27	21	17	14	12	10	9	7
		L/180	◆◆◆	◆◆◆	◆◆◆	◆◆◆	◆◆◆	107	78	58	45	35	28	23	19	16	13	11	10
		Stress	300	300	300	274	210	166	134	111	93	79	68	60	52	46	41	37	34
	16	L/360	◆◆◆	◆◆◆	◆◆◆	◆◆◆	◆◆◆	◆◆◆	◆◆◆	◆◆◆	◆◆◆	◆◆◆	◆◆◆	◆◆◆	◆◆◆	◆◆◆	◆◆◆	◆◆◆	◆◆◆
		L/240	◆◆◆	◆◆◆	◆◆◆	200	134	94	69	52	40	31	25	20	17	14	12	10	9
		L/180	◆◆◆	◆◆◆	◆◆◆	◆◆◆	201	141	103	78	60	47	38	31	25	21	18	15	13
DOUBLE	22	Stress	300	300	225	165	127	100	81	67	56	48	41	36	32	28	25	22	20
		L/360	◆◆◆	◆◆◆	◆◆◆	◆◆◆	◆◆◆	◆◆◆	◆◆◆	◆◆◆	◆◆◆	◆◆◆	◆◆◆	◆◆◆	◆◆◆	◆◆◆	◆◆◆	◆◆◆	◆◆◆
		L/240	◆◆◆	◆◆◆	◆◆◆	◆◆◆	◆◆◆	◆◆◆	◆◆◆	◆◆◆	◆◆◆	◆◆◆	◆◆◆	◆◆◆	◆◆◆	◆◆◆	◆◆◆	◆◆◆	◆◆◆
	20	L/180	◆◆◆	◆◆◆	◆◆◆	◆◆◆	◆◆◆	◆◆◆	◆◆◆	◆◆◆	◆◆◆	◆◆◆	◆◆◆	◆◆◆	◆◆◆	◆◆◆	◆◆◆	◆◆◆	◆◆◆
		Stress	300	300	283	208	159	126	102	84	71	60	52	45	40	35	31	28	25
		L/360	◆◆◆	◆◆◆	◆◆◆	◆◆◆	◆◆◆	◆◆◆	◆◆◆	◆◆◆	◆◆◆	◆◆◆	◆◆◆	◆◆◆	◆◆◆	◆◆◆	◆◆◆	◆◆◆	◆◆◆
	18	L/240	◆◆◆	◆◆◆	◆◆◆	◆◆◆	◆◆◆	◆◆◆	◆◆◆	◆◆◆	◆◆◆	◆◆◆	◆◆◆	◆◆◆	◆◆◆	◆◆◆	◆◆◆	◆◆◆	◆◆◆
		L/180	◆◆◆	◆◆◆	◆◆◆	◆◆◆	◆◆◆	◆◆◆	◆◆◆	◆◆◆	◆◆◆	◆◆◆	◆◆◆	◆◆◆	◆◆◆	◆◆◆	◆◆◆	◆◆◆	◆◆◆
		Stress	300	300	300	295	226	178	144	119	100	85	74	64	56	50	45	40	36
	16	L/360	◆◆◆	◆◆◆	◆◆◆	◆◆◆	◆◆◆	◆◆◆	◆◆◆	◆◆◆	◆◆◆	◆◆◆	◆◆◆	◆◆◆	◆◆◆	◆◆◆	◆◆◆	◆◆◆	◆◆◆
		L/240	◆◆◆	◆◆◆	◆◆◆	◆◆◆	◆◆◆	◆◆◆	◆◆◆	◆◆◆	◆◆◆	◆◆◆	◆◆◆	◆◆◆	◆◆◆	◆◆◆	◆◆◆	◆◆◆	◆◆◆
		L/180	◆◆◆	◆◆◆	◆◆◆	◆◆◆	◆◆◆	◆◆◆	◆◆◆	◆◆◆	◆◆◆	◆◆◆	◆◆◆	◆◆◆	◆◆◆	◆◆◆	◆◆◆	◆◆◆	◆◆◆
TRIPLE	22	Stress	300	300	300	300	291	230	186	154	129	110	95	83	73	64	58	52	47
		L/360	◆◆◆	◆◆◆	◆◆◆	◆◆◆	◆◆◆	◆◆◆	◆◆◆	◆◆◆	◆◆◆	◆◆◆	◆◆◆	◆◆◆	◆◆◆	◆◆◆	◆◆◆	◆◆◆	◆◆◆
		L/240	◆◆◆	◆◆◆	◆◆◆	◆◆◆	◆◆◆	◆◆◆	◆◆◆	◆◆◆	◆◆◆	◆◆◆	◆◆◆	◆◆◆	◆◆◆	◆◆◆	◆◆◆	◆◆◆	◆◆◆
	20	L/180	◆◆◆	◆◆◆	◆◆◆	◆◆◆	◆◆◆	◆◆◆	◆◆◆	◆◆◆	◆◆◆	◆◆◆	◆◆◆	◆◆◆	◆◆◆	◆◆◆	◆◆◆	◆◆◆	◆◆◆
		Stress	300	300	300	260	199	157	127	105	88	75	65	57	50	44	39	35	32
		L/360	◆◆◆	◆◆◆	◆◆◆	◆◆◆	◆◆◆	◆◆◆	◆◆◆	◆◆◆	◆◆◆	◆◆◆	◆◆◆	◆◆◆	◆◆◆	◆◆◆	◆◆◆	◆◆◆	◆◆◆
	18	L/240	◆◆◆	◆◆◆	◆◆◆	◆◆◆	◆◆◆	◆◆◆	◆◆◆	◆◆◆	◆◆◆	◆◆◆	◆◆◆	◆◆◆	◆◆◆	◆◆◆	◆◆◆	◆◆◆	◆◆◆
		L/180	◆◆◆	◆◆◆	◆◆◆	◆◆◆	◆◆◆	◆◆◆	◆◆◆	◆◆◆	◆◆◆	◆◆◆	◆◆◆	◆◆◆	◆◆◆	◆◆◆	◆◆◆	◆◆◆	◆◆◆
		Stress	300	300	300	300	282	223	181	149	125	107	92	80	71	62	56	50	45
	16	L/360	◆◆◆	◆◆◆	◆◆◆	◆◆◆	◆◆◆	◆◆◆	◆◆◆	◆◆◆	◆◆◆	◆◆◆	◆◆◆	◆◆◆	◆◆◆	◆◆◆	◆◆◆	◆◆◆	◆◆◆
		L/240	◆◆◆	◆◆◆	◆◆◆	◆◆◆	◆◆◆	◆◆◆	◆◆◆	◆◆◆	◆◆◆	◆◆◆	◆◆◆	◆◆◆	◆◆◆	◆◆◆	◆◆◆	◆◆◆	◆◆◆
		L/180	◆◆◆	◆◆◆	◆◆◆	◆◆◆	◆◆◆	◆◆◆	◆◆◆	◆◆◆	◆◆◆	◆◆◆	◆◆◆	◆◆◆	◆◆◆	◆◆◆	◆◆◆	◆◆◆	◆◆◆

See footnotes on page 81.

Type PLN3™

- 32/5 Weld Pattern at Supports
- Sidelaps Connected with PunchLok II Tool

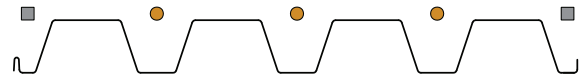

Allowable Diaphragm Shear Strength, q (plf) and Flexibility Factors, F ((in./lb)x10⁶)

DECK GAGE	SIDELAP ATTACHMENT	SPAN (ft.-in.)									
		4'-0"	6'-0"	8'-0"	10'-0"	12'-0"	14'-0"	16'-0"	18'-0"	20'-0"	
22	VSC2 @ 24"	q	601	516	474	449	433	421	412	405	400
		F	8.1+68R	11.6+44R	13.9+32R	15.5+25R	16.7+20R	17.6+17R	18.4+15R	19+13R	19.5+11R
	VSC2 @ 18"	q	758	631	636	581	543	559	534	513	528
		F	6.9+68R	10.3+45R	11.4+33R	13+26R	14.3+21R	14.4+18R	15.3+16R	16+14R	15.9+12R
	VSC2 @ 12"	q	881	810	772	749	734	722	714	665	538
		F	6+69R	8.4+45R	9.8+34R	10.7+27R	11.4+22R	11.8+19R	12.2+16R	12.5+15R	12.7+13R
	VSC2 @ 8"	q	1086	1031	1002	984	971	963	841	665	538
		F	4.7+70R	6.8+46R	7.9+34R	8.6+27R	9+23R	9.4+20R	9.6+17R	9.8+15R	10+14R
	VSC2 @ 6"	q	1241	1200	1178	1164	1155	1099	841	665	538
		F	3.9+70R	5.8+46R	6.7+35R	7.3+28R	7.7+23R	8+20R	8.2+17R	8.4+15R	8.5+14R
	VSC2 @ 4"	q	1444	1421	1409	1401	1396	1099	841	665	538
		F	3+70R	4.6+47R	5.5+35R	6+28R	6.3+23R	6.5+20R	6.7+17R	6.9+16R	7+14R
20	VSC2 @ 24"	q	854	726	666	630	606	589	577	566	557
		F	7.6+43R	10+27R	11.5+20R	12.6+16R	13.4+13R	14+11R	14.4+9R	14.8+8R	15.2+7R
	VSC2 @ 18"	q	1042	871	878	803	752	774	738	711	708
		F	6.4+43R	8.8+28R	9.4+21R	10.5+16R	11.4+13R	11.3+11R	11.9+10R	12.4+9R	12.3+8R
	VSC2 @ 12"	q	1206	1112	1062	1031	1010	994	983	874	708
		F	5.6+44R	7.2+29R	8.1+21R	8.6+17R	9+14R	9.3+12R	9.5+10R	9.7+9R	9.9+8R
	VSC2 @ 8"	q	1473	1402	1365	1341	1325	1313	1106	874	708
		F	4.5+44R	5.8+29R	6.5+22R	6.9+17R	7.2+14R	7.4+12R	7.6+11R	7.7+10R	7.8+9R
	VSC2 @ 6"	q	1671	1619	1591	1573	1562	1444	1106	874	708
		F	3.9+44R	5+29R	5.6+22R	6+18R	6.2+15R	6.4+13R	6.6+11R	6.7+10R	6.7+9R
	VSC2 @ 4"	q	1922	1894	1879	1869	1863	1444	1106	874	708
		F	3.1+44R	4.1+30R	4.7+22R	5+18R	5.2+15R	5.3+13R	5.5+11R	5.5+10R	5.6+9R
18	VSC2 @ 24"	q	1379	1179	1075	1011	967	936	912	894	879
		F	5.8+21R	7+13R	7.7+10R	8.1+8R	8.5+6R	8.7+5R	8.9+5R	9+4R	9.1+4R
	VSC2 @ 18"	q	1661	1386	1389	1269	1187	1218	1162	1118	1085
		F	4.9+21R	6.1+14R	6.2+10R	6.8+8R	7.2+7R	7.1+6R	7.3+5R	7.6+4R	7.4+4R
	VSC2 @ 12"	q	1909	1753	1670	1619	1584	1558	1539	1339	1085
		F	4.3+21R	5+14R	5.4+11R	5.6+8R	5.8+7R	5.9+6R	6+5R	6+5R	6.1+4R
	VSC2 @ 8"	q	2309	2193	2131	2092	2065	2046	1695	1339	1085
		F	3.5+22R	4.1+14R	4.4+11R	4.6+9R	4.7+7R	4.8+6R	4.9+5R	4.9+5R	5+4R
	VSC2 @ 6"	q	2602	2518	2472	2444	2424	2213	1695	1339	1085
		F	3.1+22R	3.6+14R	3.9+11R	4.1+9R	4.2+7R	4.2+6R	4.3+5R	4.4+5R	4.4+4R
	VSC2 @ 4"	q	2973	2928	2903	2888	2878	2213	1695	1339	1085
		F	2.6+22R	3.1+14R	3.4+11R	3.5+9R	3.6+7R	3.7+6R	3.7+5R	3.8+5R	3.8+4R
16	VSC2 @ 24"	q	1790	1545	1417	1338	1284	1246	1217	1194	1176
		F	5.2+11R	6.1+7R	6.6+5R	6.9+4R	7.1+3R	7.3+3R	7.5+2R	7.6+2R	7.7+2R
	VSC2 @ 18"	q	2165	1821	1836	1684	1578	1623	1551	1494	1514
		F	4.4+12R	5.3+8R	5.3+6R	5.7+4R	6.1+4R	5.9+3R	6.2+3R	6.3+2R	6.2+2R
	VSC2 @ 12"	q	2490	2305	2206	2144	2102	2072	2048	1869	1514
		F	3.8+12R	4.3+8R	4.6+6R	4.7+5R	4.8+4R	4.9+3R	5+3R	5+3R	5.1+2R
	VSC2 @ 8"	q	3004	2870	2798	2753	2722	2699	2365	1869	1514
		F	3.2+12R	3.6+8R	3.8+6R	3.9+5R	4+4R	4+3R	4.1+3R	4.1+3R	4.1+2R
	VSC2 @ 6"	q	3369	3274	3223	3191	3169	3089	2365	1869	1514
		F	2.8+12R	3.2+8R	3.3+6R	3.4+5R	3.5+4R	3.6+4R	3.6+3R	3.6+3R	3.6+2R
	VSC2 @ 4"	q	3817	3768	3741	3725	3714	3089	2365	1869	1514
		F	2.4+12R	2.7+8R	2.9+6R	3+5R	3+4R	3.1+4R	3.1+3R	3.1+3R	3.1+2R

See footnotes on page 82.

Type PLN3™

- 32/5 Hilti Fastener Pattern at Supports
X-EDNK22 at Supports 1/8" to 1/4" thick
X-HSN24 at Supports 1/8" to 3/8" thick
- Sidelaps Connected with PunchLok II Tool

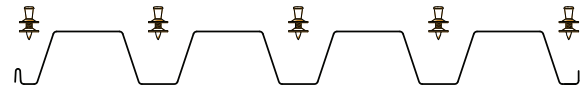

Allowable Diaphragm Shear Strength, q (plf) and Flexibility Factors, F ((in./lb)x10⁶)

DECK GAGE	SIDELAP ATTACHMENT	SPAN (ft.-in.)									
		4'-0"	6'-0"	8'-0"	10'-0"	12'-0"	14'-0"	16'-0"	18'-0"	20'-0"	
22	VSC2 @ 24"	q	569	515	487	469	457	448	441	436	432
		F	8.5+68R	12.1+44R	14.3+32R	15.9+25R	17.1+20R	18+17R	18.7+15R	19.3+13R	19.9+11R
	VSC2 @ 18"	q	689	607	625	585	557	575	555	539	538
		F	7.2+68R	10.6+45R	11.7+33R	13.3+26R	14.6+21R	14.6+18R	15.5+16R	16.2+14R	16+12R
	VSC2 @ 12"	q	781	749	732	721	713	708	704	665	538
		F	6.2+69R	8.6+45R	10+34R	10.9+27R	11.5+22R	12+19R	12.3+17R	12.6+15R	12.8+13R
	VSC2 @ 8"	q	903	884	875	868	864	861	841	665	538
		F	4.9+70R	6.9+46R	8+34R	8.6+27R	9.1+23R	9.4+20R	9.7+17R	9.9+15R	10+14R
	VSC2 @ 6"	q	974	963	958	954	951	950	841	665	538
		F	4+70R	5.9+46R	6.8+35R	7.4+28R	7.8+23R	8+20R	8.3+17R	8.4+15R	8.6+14R
	VSC2 @ 4"	q	1047	1042	1040	1038	1037	1036	841	665	538
		F	3+70R	4.7+47R	5.5+35R	6+28R	6.3+23R	6.6+20R	6.7+17R	6.9+16R	7+14R
20	VSC2 @ 24"	q	731	672	640	621	607	597	590	584	580
		F	7.9+42R	10.3+27R	11.8+20R	12.9+16R	13.6+13R	14.2+11R	14.7+9R	15+8R	15.4+7R
	VSC2 @ 18"	q	881	788	814	767	734	758	734	715	708
		F	6.6+43R	9+28R	9.6+21R	10.7+16R	11.5+13R	11.5+12R	12.1+10R	12.6+9R	12.4+8R
	VSC2 @ 12"	q	989	958	941	930	923	917	913	874	708
		F	5.7+44R	7.3+29R	8.2+21R	8.7+17R	9.1+14R	9.4+12R	9.6+10R	9.8+9R	9.9+8R
	VSC2 @ 8"	q	1126	1109	1100	1094	1090	1087	1085	874	708
		F	4.6+44R	5.9+29R	6.6+22R	7+17R	7.3+14R	7.5+12R	7.6+11R	7.8+10R	7.9+9R
	VSC2 @ 6"	q	1200	1191	1186	1183	1180	1179	1106	874	708
		F	3.9+44R	5.1+29R	5.7+22R	6+18R	6.3+15R	6.4+13R	6.6+11R	6.7+10R	6.8+9R
	VSC2 @ 4"	q	1272	1268	1266	1265	1264	1263	1106	874	708
		F	3.1+44R	4.2+30R	4.7+22R	5+18R	5.2+15R	5.4+13R	5.5+11R	5.6+10R	5.6+9R
18	VSC2 @ 24"	q	1042	972	935	911	895	884	875	868	862
		F	6+21R	7.1+13R	7.8+10R	8.2+8R	8.5+6R	8.8+5R	9+5R	9.1+4R	9.2+4R
	VSC2 @ 18"	q	1244	1130	1170	1112	1070	1104	1073	1048	1075
		F	5+21R	6.2+14R	6.3+10R	6.8+8R	7.2+7R	7.1+6R	7.4+5R	7.6+4R	7.5+4R
	VSC2 @ 12"	q	1381	1348	1331	1320	1312	1307	1303	1299	1085
		F	4.3+21R	5+14R	5.4+11R	5.6+8R	5.8+7R	5.9+6R	6+5R	6+5R	6.1+4R
	VSC2 @ 8"	q	1542	1526	1517	1512	1508	1506	1504	1339	1085
		F	3.5+22R	4.1+14R	4.4+11R	4.6+9R	4.7+7R	4.8+6R	4.9+5R	4.9+5R	5+4R
	VSC2 @ 6"	q	1624	1615	1611	1608	1606	1605	1604	1339	1085
		F	3.1+22R	3.6+14R	3.9+11R	4.1+9R	4.2+7R	4.3+6R	4.3+5R	4.4+5R	4.4+4R
	VSC2 @ 4"	q	1699	1695	1694	1693	1692	1691	1691	1339	1085
		F	2.6+22R	3.1+14R	3.4+11R	3.5+9R	3.6+7R	3.7+6R	3.7+5R	3.8+5R	3.8+4R
16	VSC2 @ 24"	q	1346	1266	1223	1196	1178	1164	1154	1146	1140
		F	5.3+11R	6.2+7R	6.7+5R	7+4R	7.2+3R	7.4+3R	7.5+3R	7.6+2R	7.7+2R
	VSC2 @ 18"	q	1595	1463	1514	1446	1396	1439	1402	1372	1405
		F	4.5+12R	5.4+8R	5.4+6R	5.8+5R	6.1+4R	6+3R	6.2+3R	6.4+2R	6.2+2R
	VSC2 @ 12"	q	1759	1724	1706	1694	1686	1680	1676	1672	1514
		F	3.9+12R	4.4+8R	4.6+6R	4.8+5R	4.9+4R	4.9+3R	5+3R	5+3R	5.1+2R
	VSC2 @ 8"	q	1943	1926	1918	1913	1909	1906	1904	1869	1514
		F	3.2+12R	3.6+8R	3.8+6R	3.9+5R	4+4R	4+3R	4.1+3R	4.1+3R	4.1+2R
	VSC2 @ 6"	q	2033	2025	2020	2018	2016	2014	2013	1869	1514
		F	2.9+12R	3.2+8R	3.3+6R	3.4+5R	3.5+4R	3.6+4R	3.6+3R	3.6+3R	3.6+2R
	VSC2 @ 4"	q	2113	2110	2108	2108	2107	2106	2106	1869	1514
		F	2.5+12R	2.7+8R	2.9+6R	3+5R	3+4R	3.1+4R	3.1+3R	3.1+3R	3.1+2R

See footnotes on page 82.

Type PLN3™

- 32/7 Hilti Fastener Pattern at Supports
X-EDNK22 at Supports 1/8" to 1/4" thick
X-HSN24 at Supports 1/8" to 3/8" thick
- Sidelaps Connected with PunchLok II Tool

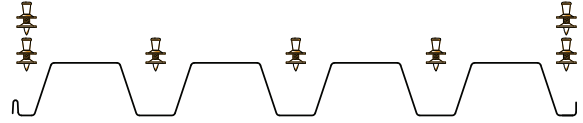

Allowable Diaphragm Shear Strength, q (plf) and Flexibility Factors, F ((in./lb)x10⁶)

DECK GAGE	SIDELAP ATTACHMENT	SPAN (ft.-in.)									
		4'-0"	6'-0"	8'-0"	10'-0"	12'-0"	14'-0"	16'-0"	18'-0"	20'-0"	
22	VSC2 @ 24"	q	747	644	588	554	530	513	500	490	481
		F	6.1+68R	9.5+44R	11.6+32R	13.3+25R	14.5+20R	15.5+17R	16.4+14R	17.1+12R	17.7+11R
	VSC2 @ 18"	q	879	745	745	684	642	657	628	605	538
		F	5.4+69R	8.6+45R	10+33R	11.5+26R	12.8+21R	13.1+18R	14+15R	14.7+13R	14.8+12R
	VSC2 @ 12"	q	989	917	877	852	835	822	812	665	538
		F	4.8+69R	7.4+45R	8.8+34R	9.8+27R	10.5+22R	11.1+19R	11.5+16R	11.8+14R	12.1+13R
	VSC2 @ 8"	q	*1155	*1106	1079	1062	1050	1041	841	665	538
		F	4+70R	6.2+46R	7.3+34R	8.1+27R	8.6+23R	9+19R	9.3+17R	9.5+15R	9.7+13R
	VSC2 @ 6"	q	*1266	*1233	*1215	*1203	*1195	1099	841	665	538
		F	3.4+70R	5.4+46R	6.4+35R	7+28R	7.4+23R	7.8+20R	8+17R	8.2+15R	8.3+14R
	VSC2 @ 4"	q	*1395	*1379	*1370	*1365	*1361	1099	841	665	538
		F	2.7+70R	4.4+47R	5.3+35R	5.8+28R	6.2+23R	6.4+20R	6.6+17R	6.8+15R	6.9+14R
20	VSC2 @ 24"	q	947	831	767	728	701	681	667	655	645
		F	6+43R	8.4+28R	9.9+20R	11.1+15R	11.9+13R	12.6+10R	13.2+9R	13.6+8R	14+7R
	VSC2 @ 18"	q	1118	963	971	899	849	871	836	807	708
		F	5.3+43R	7.6+28R	8.4+21R	9.5+16R	10.4+13R	10.5+11R	11.1+10R	11.6+8R	11.6+8R
	VSC2 @ 12"	q	1255	1179	1138	1111	1093	1079	1069	874	708
		F	4.8+44R	6.5+29R	7.4+21R	8.1+17R	8.5+14R	8.9+12R	9.1+10R	9.3+9R	9.5+8R
	VSC2 @ 8"	q	*1451	*1403	*1377	*1360	*1348	*1340	1106	874	708
		F	4.1+44R	5.4+29R	6.2+22R	6.6+17R	7+14R	7.2+12R	7.4+11R	7.5+9R	7.6+9R
	VSC2 @ 6"	q	*1575	*1544	*1527	*1517	*1509	*1444	1106	874	708
		F	3.5+44R	4.8+29R	5.4+22R	5.8+17R	6.1+15R	6.3+12R	6.4+11R	6.5+10R	6.6+9R
	VSC2 @ 4"	q	*1710	*1696	*1689	*1684	*1681	*1444	1106	874	708
		F	2.9+44R	4+30R	4.6+22R	4.9+18R	5.1+15R	5.3+13R	5.4+11R	5.5+10R	5.6+9R
18	VSC2 @ 24"	q	1335	1192	1115	1066	1033	1009	990	976	964
		F	5+21R	6.2+13R	7+10R	7.5+8R	7.9+6R	8.2+5R	8.4+4R	8.6+4R	8.7+3R
	VSC2 @ 18"	q	1576	1382	1405	1312	1246	1281	1234	1196	1085
		F	4.4+21R	5.6+14R	5.8+10R	6.4+8R	6.8+7R	6.8+6R	7.1+5R	7.3+4R	7.2+4R
	VSC2 @ 12"	q	*1761	1676	1630	1600	1580	1565	1554	1339	1085
		F	3.9+21R	4.7+14R	5.1+10R	5.4+8R	5.6+7R	5.7+6R	5.8+5R	5.9+5R	6+4R
	VSC2 @ 8"	q	*2008	*1959	*1932	*1915	*1903	*1894	1695	1339	1085
		F	3.3+21R	4+14R	4.3+11R	4.5+9R	4.6+7R	4.7+6R	4.8+5R	4.9+5R	4.9+4R
	VSC2 @ 6"	q	*2154	*2124	*2108	*2098	*2091	*2086	1695	1339	1085
		F	3+22R	3.5+14R	3.8+11R	4+9R	4.1+7R	4.2+6R	4.3+5R	4.3+5R	4.4+4R
	VSC2 @ 4"	q	*2304	*2291	*2285	*2280	*2278	*2213	1695	1339	1085
		F	2.6+22R	3.1+14R	3.3+11R	3.5+9R	3.6+7R	3.6+6R	3.7+5R	3.7+5R	3.8+4R
16	VSC2 @ 24"	q	1717	1549	1458	1400	1361	1332	1310	1293	1279
		F	4.5+12R	5.4+7R	6+5R	6.4+4R	6.7+3R	6.9+3R	7.1+2R	7.2+2R	7.3+2R
	VSC2 @ 18"	q	2024	1793	1829	1716	1635	1682	1624	1578	1514
		F	4+12R	4.9+8R	5+6R	5.4+4R	5.8+4R	5.7+3R	5.9+3R	6.1+2R	6+2R
	VSC2 @ 12"	q	*2252	2159	2107	2075	2052	2036	2023	1869	1514
		F	3.6+12R	4.1+8R	4.4+6R	4.6+5R	4.7+4R	4.8+3R	4.9+3R	4.9+3R	5+2R
	VSC2 @ 8"	q	*2545	*2494	*2466	*2448	*2436	*2427	*2365	1869	1514
		F	3.1+12R	3.5+8R	3.7+6R	3.8+5R	3.9+4R	4+3R	4+3R	4+3R	4.1+2R
	VSC2 @ 6"	q	*2713	*2683	*2666	*2656	*2649	*2644	*2365	1869	1514
		F	2.8+12R	3.1+8R	3.3+6R	3.4+5R	3.5+4R	3.5+3R	3.6+3R	3.6+3R	3.6+2R
	VSC2 @ 4"	q	*2878	*2866	*2860	*2856	*2853	*2851	*2365	1869	1514
		F	2.4+12R	2.7+8R	2.9+6R	2.9+5R	3+4R	3.1+4R	3.1+3R	3.1+3R	3.1+2R

1. For diaphragm shear strengths in bold and marked with *, the fastening pattern shall be increased at the building perimeter, chords, collectors to other shear transfer elements to two fasteners per rib (i.e. 32/10 pattern) or shall be limited to 1100 plf, 1300 plf, 1700 plf or 2200 plf for 22, 20, 18 or 16 gage steel deck, respectively. Bearing at supports shall allow for proper end distance and fastener spacing.
2. See additional footnotes on page 82.

Type PLN3™

- 32/5 Hilti Fastener Pattern at Supports
X-ENP19 at Supports 1/4" and thicker
- Sidelaps Connected with PunchLok II Tool

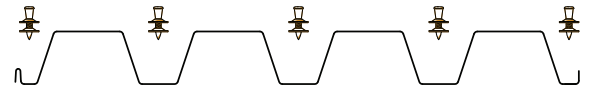

Allowable Diaphragm Shear Strength, q (plf) and Flexibility Factors, F ((in./lb)x10⁶)

DECK GAGE	SIDELAP ATTACHMENT	SPAN (ft-in.)									
		4'-0"	6'-0"	8'-0"	10'-0"	12'-0"	14'-0"	16'-0"	18'-0"	20'-0"	
22	VSC2 @ 24"	q	592	532	500	480	467	457	450	444	440
		F	6.1+68R	9.4+44R	11.6+32R	13.2+25R	14.5+20R	15.5+17R	16.4+14R	17.1+12R	17.7+11R
	VSC2 @ 18"	q	717	627	644	601	570	589	568	550	538
		F	5.4+69R	8.6+45R	10+33R	11.5+26R	12.8+21R	13.1+18R	14+15R	14.7+13R	14.7+12R
	VSC2 @ 12"	q	815	778	758	745	737	731	726	665	538
		F	4.8+69R	7.4+45R	8.8+34R	9.8+27R	10.5+22R	11+19R	11.5+16R	11.8+14R	12.1+13R
	VSC2 @ 8"	q	950	928	916	908	903	899	841	665	538
		F	4+70R	6.1+46R	7.3+34R	8.1+27R	8.6+23R	9+19R	9.3+17R	9.5+15R	9.7+13R
	VSC2 @ 6"	q	1031	1018	1010	1006	1003	1000	841	665	538
		F	3.4+70R	5.4+46R	6.4+35R	7+28R	7.4+23R	7.8+20R	8+17R	8.2+15R	8.3+14R
	VSC2 @ 4"	q	1116	1110	1107	1105	1103	1099	841	665	538
		F	2.7+70R	4.4+47R	5.3+35R	5.8+28R	6.2+23R	6.4+20R	6.6+17R	6.8+15R	6.9+14R
20	VSC2 @ 24"	q	760	694	658	636	621	610	602	596	590
		F	6+43R	8.4+28R	9.9+20R	11.1+15R	11.9+13R	12.6+10R	13.1+9R	13.6+8R	14+7R
	VSC2 @ 18"	q	918	815	841	790	754	779	753	732	708
		F	5.3+43R	7.6+28R	8.4+21R	9.5+16R	10.4+13R	10.5+11R	11.1+10R	11.6+8R	11.6+8R
	VSC2 @ 12"	q	1036	999	978	966	957	951	946	874	708
		F	4.8+44R	6.5+29R	7.4+21R	8.1+17R	8.5+14R	8.8+12R	9.1+10R	9.3+9R	9.5+8R
	VSC2 @ 8"	q	1188	1167	1156	1149	1145	1141	1106	874	708
		F	4+44R	5.4+29R	6.2+22R	6.6+17R	7+14R	7.2+12R	7.4+11R	7.5+9R	7.6+9R
	VSC2 @ 6"	q	1274	1262	1256	1252	1249	1247	1106	874	708
		F	3.5+44R	4.8+29R	5.4+22R	5.8+17R	6.1+15R	6.3+12R	6.4+11R	6.5+10R	6.6+9R
	VSC2 @ 4"	q	1358	1354	1351	1350	1348	1348	1106	874	708
		F	2.9+44R	4+30R	4.6+22R	4.9+18R	5.1+15R	5.3+13R	5.4+11R	5.5+10R	5.6+9R
18	VSC2 @ 24"	q	1084	1005	962	936	918	905	895	887	881
		F	5+21R	6.2+13R	7+10R	7.5+8R	7.9+6R	8.2+5R	8.4+4R	8.6+4R	8.7+3R
	VSC2 @ 18"	q	1299	1173	1213	1149	1103	1139	1105	1078	1085
		F	4.4+21R	5.6+14R	5.8+10R	6.4+8R	6.8+7R	6.8+6R	7.1+5R	7.3+4R	7.2+4R
	VSC2 @ 12"	q	1451	1411	1390	1377	1368	1361	1356	1339	1085
		F	3.9+21R	4.7+14R	5.1+10R	5.4+8R	5.6+7R	5.7+6R	5.8+5R	5.9+5R	6+4R
	VSC2 @ 8"	q	1633	1613	1602	1596	1591	1588	1585	1339	1085
		F	3.3+21R	4+14R	4.3+11R	4.5+9R	4.6+7R	4.7+6R	4.8+5R	4.9+5R	4.9+4R
	VSC2 @ 6"	q	1729	1718	1712	1708	1706	1704	1695	1339	1085
		F	3+22R	3.5+14R	3.8+11R	4+9R	4.1+7R	4.2+6R	4.3+5R	4.3+5R	4.4+4R
	VSC2 @ 4"	q	1818	1814	1812	1810	1809	1809	1695	1339	1085
		F	2.6+22R	3.1+14R	3.3+11R	3.5+9R	3.6+7R	3.6+6R	3.7+5R	3.7+5R	3.8+4R
16	VSC2 @ 24"	q	1401	1310	1261	1230	1209	1194	1183	1174	1166
		F	4.5+12R	5.4+7R	6+5R	6.4+4R	6.7+3R	6.9+3R	7.1+2R	7.2+2R	7.3+2R
	VSC2 @ 18"	q	1670	1521	1574	1498	1442	1488	1447	1414	1450
		F	4+12R	4.8+8R	5+6R	5.4+4R	5.8+4R	5.7+3R	5.9+3R	6.1+2R	6+2R
	VSC2 @ 12"	q	1851	1809	1787	1773	1763	1756	1750	1746	1514
		F	3.6+12R	4.1+8R	4.4+6R	4.6+5R	4.7+4R	4.8+3R	4.9+3R	4.9+3R	5+2R
	VSC2 @ 8"	q	2061	2041	2030	2023	2019	2015	2013	1869	1514
		F	3.1+12R	3.5+8R	3.7+6R	3.8+5R	3.9+4R	4+3R	4+3R	4+3R	4.1+2R
	VSC2 @ 6"	q	2168	2157	2151	2148	2145	2143	2142	1869	1514
		F	2.8+12R	3.1+8R	3.3+6R	3.4+5R	3.5+4R	3.5+3R	3.6+3R	3.6+3R	3.6+2R
	VSC2 @ 4"	q	2264	2260	2258	2256	2255	2255	2254	1869	1514
		F	2.4+12R	2.7+8R	2.9+6R	2.9+5R	3+4R	3.1+4R	3.1+3R	3.1+3R	3.1+2R

See footnotes on page 82.

Type PLN3™

- 32/5 Pneutek Fastener Pattern at Supports
SDK61 at Supports 0.113 to 0.155" thick
- Sidelaps Connected with PunchLok II Tool

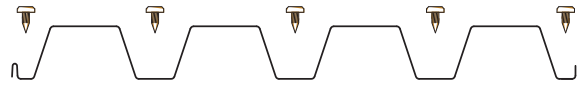

Allowable Diaphragm Shear Strength, q (plf) and Flexibility Factors, F ((in./lb)x10⁶)

DECK GAGE	SIDELAP ATTACHMENT	SPAN (ft.-in.)									
		4'-0"	6'-0"	8'-0"	10'-0"	12'-0"	14'-0"	16'-0"	18'-0"	20'-0"	
22	VSC2 @ 24"	q	577	521	491	473	460	451	444	439	435
		F	13.1+67R	16.5+44R	18.4+32R	19.6+26R	20.5+21R	21.1+18R	21.6+16R	22+14R	22.4+12R
	VSC2 @ 18"	q	698	614	631	590	561	580	559	543	538
		F	10.1+69R	13.7+45R	14+34R	15.5+27R	16.7+22R	16.4+19R	17.2+16R	17.8+15R	17.4+13R
	VSC2 @ 12"	q	792	759	740	729	721	716	711	665	538
		F	8.2+69R	10.4+46R	11.5+34R	12.1+27R	12.6+23R	12.9+19R	13.2+17R	13.4+15R	13.5+14R
	VSC2 @ 8"	q	918	899	888	882	877	874	841	665	538
		F	6+70R	7.8+46R	8.7+35R	9.3+28R	9.6+23R	9.9+20R	10.1+17R	10.3+15R	10.4+14R
	VSC2 @ 6"	q	993	981	975	971	968	967	841	665	538
		F	4.7+70R	6.4+47R	7.2+35R	7.7+28R	8.1+23R	8.3+20R	8.5+17R	8.6+16R	8.8+14R
	VSC2 @ 4"	q	1069	1064	1062	1060	1059	1058	841	665	538
		F	3.4+70R	4.9+47R	5.7+35R	6.2+28R	6.5+23R	6.7+20R	6.9+18R	7+16R	7.1+14R
20	VSC2 @ 24"	q	738	677	645	624	611	601	593	587	582
		F	11.1+42R	13.2+28R	14.4+21R	15.2+16R	15.7+13R	16.1+11R	16.4+10R	16.7+9R	16.8+8R
	VSC2 @ 18"	q	890	794	820	773	739	764	739	719	708
		F	8.6+43R	11+28R	11+21R	12.1+17R	12.9+14R	12.5+12R	13.1+10R	13.5+9R	13.2+8R
	VSC2 @ 12"	q	1001	968	950	939	931	926	922	874	708
		F	7.1+44R	8.4+29R	9.1+22R	9.5+17R	9.8+14R	10+12R	10.1+11R	10.3+10R	10.3+9R
	VSC2 @ 8"	q	1141	1123	1114	1108	1104	1101	1098	874	708
		F	5.3+44R	6.4+29R	7+22R	7.4+18R	7.6+15R	7.8+13R	7.9+11R	8+10R	8+9R
	VSC2 @ 6"	q	1218	1208	1203	1199	1197	1195	1106	874	708
		F	4.4+44R	5.4+30R	5.9+22R	6.2+18R	6.5+15R	6.6+13R	6.7+11R	6.8+10R	6.9+9R
	VSC2 @ 4"	q	1293	1289	1286	1285	1284	1284	1106	874	708
		F	3.3+45R	4.3+30R	4.8+22R	5.1+18R	5.3+15R	5.4+13R	5.5+11R	5.6+10R	5.7+9R
18	VSC2 @ 24"	q	1044	974	936	913	897	885	876	869	864
		F	7.4+21R	8.3+14R	8.8+10R	9.1+8R	9.3+7R	9.4+6R	9.5+5R	9.6+4R	9.7+4R
	VSC2 @ 18"	q	1247	1133	1172	1114	1072	1106	1075	1050	1077
		F	5.7+21R	6.9+14R	6.8+11R	7.3+8R	7.7+7R	7.4+6R	7.7+5R	7.9+5R	7.7+4R
	VSC2 @ 12"	q	1385	1352	1334	1323	1316	1310	1306	1303	1085
		F	4.8+22R	5.4+14R	5.7+11R	5.9+9R	6+7R	6.1+6R	6.1+5R	6.2+5R	6.2+4R
	VSC2 @ 8"	q	1547	1531	1522	1517	1513	1511	1509	1339	1085
		F	3.8+22R	4.3+14R	4.6+11R	4.7+9R	4.8+7R	4.9+6R	5+5R	5+5R	5+4R
	VSC2 @ 6"	q	1630	1622	1617	1614	1612	1611	1610	1339	1085
		F	3.3+22R	3.7+14R	4+11R	4.1+9R	4.2+7R	4.3+6R	4.4+5R	4.4+5R	4.4+4R
	VSC2 @ 4"	q	1706	1702	1701	1700	1699	1699	1695	1339	1085
		F	2.7+22R	3.2+15R	3.4+11R	3.5+9R	3.6+7R	3.7+6R	3.7+5R	3.8+5R	3.8+4R
16	VSC2 @ 24"	q	1339	1260	1218	1191	1173	1160	1150	1143	1136
		F	6.5+12R	7.1+8R	7.5+6R	7.7+5R	7.8+4R	7.9+3R	8+3R	8.1+2R	8.1+2R
	VSC2 @ 18"	q	1586	1456	1507	1439	1390	1432	1396	1366	1399
		F	5.1+12R	5.9+8R	5.7+6R	6.1+5R	6.4+4R	6.2+3R	6.4+3R	6.6+3R	6.5+2R
	VSC2 @ 12"	q	1747	1714	1695	1684	1676	1670	1666	1663	1514
		F	4.3+12R	4.7+8R	4.8+6R	5+5R	5+4R	5.1+3R	5.1+3R	5.2+3R	5.2+2R
	VSC2 @ 8"	q	1927	1912	1904	1898	1895	1892	1890	1869	1514
		F	3.4+12R	3.7+8R	3.9+6R	4+5R	4.1+4R	4.1+4R	4.1+3R	4.2+3R	4.2+2R
	VSC2 @ 6"	q	2016	2008	2004	2001	1999	1998	1997	1869	1514
		F	3+12R	3.3+8R	3.4+6R	3.5+5R	3.6+4R	3.6+4R	3.6+3R	3.6+3R	3.7+2R
	VSC2 @ 4"	q	2094	2091	2090	2089	2088	2088	2087	1869	1514
		F	2.5+12R	2.8+8R	2.9+6R	3+5R	3+4R	3.1+4R	3.1+3R	3.1+3R	3.2+2R

See footnotes on page 82.

Type PLN3™

- 32/7 Pneutek Fastener Pattern at Supports
SDK61 at Supports 0.113 to 0.155" thick
- Sidelaps Connected with PunchLok II Tool



Allowable Diaphragm Shear Strength, q (plf) and Flexibility Factors, F ((in./lb)x10⁶)

DECK GAGE	SIDELAP ATTACHMENT	SPAN (ft-in.)									
		4'-0"	6'-0"	8'-0"	10'-0"	12'-0"	14'-0"	16'-0"	18'-0"	20'-0"	
22	VSC2 @ 24"	q	759	652	595	559	534	517	503	493	484
		F	10.4+67R	14+44R	16.2+32R	17.7+25R	18.7+21R	19.5+17R	20.2+15R	20.7+13R	21.1+12R
	VSC2 @ 18"	q	892	754	752	691	647	662	633	609	538
		F	8.5+68R	12+45R	12.8+33R	14.4+26R	15.6+22R	15.5+18R	16.3+16R	17+14R	16.8+13R
	VSC2 @ 12"	q	1004	928	887	861	843	829	819	665	538
		F	7.1+69R	9.5+46R	10.7+34R	11.5+27R	12.1+22R	12.5+19R	12.8+17R	13+15R	13.2+13R
	VSC2 @ 8"	q	*1173	*1122	1093	1075	1063	1053	841	665	538
		F	5.4+70R	7.3+46R	8.3+35R	9+28R	9.4+23R	9.7+20R	9.9+17R	10.1+15R	10.2+14R
	VSC2 @ 6"	q	*1288	*1253	*1234	*1222	*1213	1099	841	665	538
		F	4.4+70R	6.1+47R	7+35R	7.6+28R	7.9+23R	8.2+20R	8.4+17R	8.5+15R	8.7+14R
	VSC2 @ 4"	q	*1423	*1406	*1396	*1391	*1386	1099	841	665	538
		F	3.2+70R	4.8+47R	5.6+35R	6.1+28R	6.4+23R	6.6+20R	6.8+18R	6.9+16R	7.1+14R
20	VSC2 @ 24"	q	958	838	773	733	705	685	670	658	648
		F	9.3+42R	11.7+27R	13.1+20R	14+16R	14.7+13R	15.2+11R	15.5+9R	15.9+8R	16.1+7R
	VSC2 @ 18"	q	1130	972	979	906	854	876	840	812	708
		F	7.5+43R	9.9+28R	10.3+21R	11.4+17R	12.2+14R	12+12R	12.6+10R	13.1+9R	12.8+8R
	VSC2 @ 12"	q	1269	1191	1147	1120	1101	1087	1077	874	708
		F	6.4+44R	7.8+29R	8.6+22R	9.1+17R	9.5+14R	9.7+12R	9.9+11R	10+9R	10.1+8R
	VSC2 @ 8"	q	*1469	*1419	*1391	*1374	*1362	*1353	1106	874	708
		F	5+44R	6.2+29R	6.8+22R	7.2+18R	7.4+15R	7.6+12R	7.8+11R	7.9+10R	8+9R
	VSC2 @ 6"	q	*1596	*1564	*1546	*1535	*1528	*1444	1106	874	708
		F	4.1+44R	5.2+29R	5.8+22R	6.1+18R	6.4+15R	6.5+13R	6.6+11R	6.7+10R	6.8+9R
	VSC2 @ 4"	q	*1736	*1722	*1714	*1709	*1705	*1444	1106	874	708
		F	3.2+44R	4.2+30R	4.7+22R	5+18R	5.2+15R	5.4+13R	5.5+11R	5.6+10R	5.7+9R
18	VSC2 @ 24"	q	1339	1195	1117	1068	1034	1010	991	977	965
		F	6.6+21R	7.7+14R	8.3+10R	8.7+8R	8.9+7R	9.1+6R	9.3+5R	9.4+4R	9.5+4R
	VSC2 @ 18"	q	1581	1385	1408	1314	1248	1283	1236	1198	1085
		F	5.3+21R	6.5+14R	6.5+10R	7.1+8R	7.5+7R	7.3+6R	7.6+5R	7.8+5R	7.6+4R
	VSC2 @ 12"	q	1766	1681	1634	1604	1584	1569	1557	1339	1085
		F	4.6+21R	5.2+14R	5.5+11R	5.8+8R	5.9+7R	6+6R	6.1+5R	6.1+5R	6.2+4R
	VSC2 @ 8"	q	*2014	*1965	*1938	*1920	*1908	*1900	1695	1339	1085
		F	3.7+22R	4.2+14R	4.5+11R	4.7+9R	4.8+7R	4.9+6R	4.9+5R	5+5R	5+4R
	VSC2 @ 6"	q	*2162	*2132	*2116	*2105	*2098	*2093	1695	1339	1085
		F	3.2+22R	3.7+14R	3.9+11R	4.1+9R	4.2+7R	4.3+6R	4.3+5R	4.4+5R	4.4+4R
	VSC2 @ 4"	q	*2313	*2300	*2294	*2289	*2287	*2213	1695	1339	1085
		F	2.7+22R	3.1+15R	3.4+11R	3.5+9R	3.6+7R	3.7+6R	3.7+5R	3.8+5R	3.8+4R
16	VSC2 @ 24"	q	1707	1542	1452	1395	1356	1328	1306	1290	1276
		F	5.9+12R	6.6+7R	7.1+5R	7.3+4R	7.5+4R	7.7+3R	7.8+3R	7.8+2R	7.9+2R
	VSC2 @ 18"	q	2012	1784	1820	1709	1629	1676	1619	1573	1514
		F	4.8+12R	5.6+8R	5.6+6R	6+5R	6.3+4R	6.1+3R	6.3+3R	6.5+3R	6.4+2R
	VSC2 @ 12"	q	*2237	*2146	2096	2064	2042	2026	2014	1869	1514
		F	4.1+12R	4.5+8R	4.7+6R	4.9+5R	5+4R	5+3R	5.1+3R	5.1+3R	5.1+2R
	VSC2 @ 8"	q	*2527	*2477	*2450	*2432	*2420	*2411	*2365	1869	1514
		F	3.3+12R	3.7+8R	3.8+6R	3.9+5R	4+4R	4.1+3R	4.1+3R	4.1+3R	4.2+2R
	VSC2 @ 6"	q	*2692	*2662	*2647	*2637	*2630	*2625	*2365	1869	1514
		F	2.9+12R	3.2+8R	3.4+6R	3.5+5R	3.5+4R	3.6+4R	3.6+3R	3.6+3R	3.7+2R
	VSC2 @ 4"	q	*2854	*2842	*2836	*2832	*2829	*2827	*2365	1869	1514
		F	2.5+12R	2.8+8R	2.9+6R	3+5R	3+4R	3.1+4R	3.1+3R	3.1+3R	3.2+2R

1. For diaphragm shear strengths in bold and marked with *, the fastening pattern shall be increased at the building perimeter, chords, collectors to other shear transfer elements to two fasteners per rib (i.e. 32/10 pattern) or shall be limited to 1100 plf, 1300 plf, 1800 plf or 2100 plf for 22, 20, 18 or 16 gage steel deck, respectively. Bearing at supports shall allow for proper end distance and fastener spacing.
2. See additional footnotes on page 82.

Type PLN3™

- 32/5 Pneutek Fastener Pattern at Supports
SDK63 at Supports 0.155 to 0.250" thick
- Sidelaps Connected with PunchLok II Tool

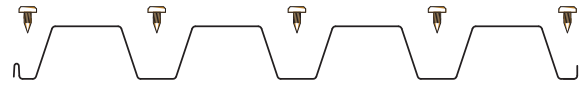

Allowable Diaphragm Shear Strength, q (plf) and Flexibility Factors, F ((in./lb)x10⁶)

DECK GAGE	SIDELAP ATTACHMENT	SPAN (ft.-in.)									
		4'-0"	6'-0"	8'-0"	10'-0"	12'-0"	14'-0"	16'-0"	18'-0"	20'-0"	
22	VSC2 @ 24"	q	612	546	512	490	475	465	457	451	446
		F	13.1+67R	16.5+44R	18.4+32R	19.6+26R	20.5+21R	21.1+18R	21.6+16R	22+14R	22.4+12R
	VSC2 @ 18"	q	741	644	660	614	582	601	578	560	538
		F	10.1+69R	13.7+45R	14+34R	15.5+27R	16.7+22R	16.4+19R	17.2+16R	17.8+15R	17.4+13R
	VSC2 @ 12"	q	845	803	780	766	756	749	744	665	538
		F	8.2+69R	10.4+46R	11.5+34R	12.1+27R	12.6+23R	12.9+19R	13.2+17R	13.4+15R	13.5+14R
	VSC2 @ 8"	q	990	964	950	941	935	931	841	665	538
		F	6+70R	7.8+46R	8.7+35R	9.3+28R	9.6+23R	9.9+20R	10.1+17R	10.3+15R	10.4+14R
	VSC2 @ 6"	q	1080	1064	1055	1050	1046	1043	841	665	538
		F	4.7+70R	6.4+47R	7.2+35R	7.7+28R	8.1+23R	8.3+20R	8.5+17R	8.6+16R	8.8+14R
	VSC2 @ 4"	q	1176	1169	1165	1163	1161	1099	841	665	538
		F	3.4+70R	4.9+47R	5.7+35R	6.2+28R	6.5+23R	6.7+20R	6.9+18R	7+16R	7.1+14R
20	VSC2 @ 24"	q	768	700	663	640	625	614	605	599	593
		F	11.1+42R	13.2+28R	14.4+21R	15.2+16R	15.7+13R	16.1+11R	16.4+10R	16.7+9R	16.8+8R
	VSC2 @ 18"	q	928	822	848	796	759	785	758	737	708
		F	8.6+43R	11+28R	11+21R	12.1+17R	12.9+14R	12.5+12R	13.1+10R	13.5+9R	13.2+8R
	VSC2 @ 12"	q	1048	1009	988	975	966	960	955	874	708
		F	7.1+44R	8.4+29R	9.1+22R	9.5+17R	9.8+14R	10+12R	10.1+11R	10.3+10R	10.3+9R
	VSC2 @ 8"	q	1205	1183	1171	1164	1159	1155	1106	874	708
		F	5.3+44R	6.4+29R	7+22R	7.4+18R	7.6+15R	7.8+13R	7.9+11R	8+10R	8+9R
	VSC2 @ 6"	q	1294	1281	1275	1270	1268	1265	1106	874	708
		F	4.4+44R	5.4+30R	5.9+22R	6.2+18R	6.5+15R	6.6+13R	6.7+11R	6.8+10R	6.9+9R
	VSC2 @ 4"	q	1382	1377	1375	1373	1372	1371	1106	874	708
		F	3.3+45R	4.3+30R	4.8+22R	5.1+18R	5.3+15R	5.4+13R	5.5+11R	5.6+10R	5.7+9R
18	VSC2 @ 24"	q	1054	981	942	918	902	890	881	874	868
		F	7.4+21R	8.3+14R	8.8+10R	9.1+8R	9.3+7R	9.4+6R	9.5+5R	9.6+4R	9.7+4R
	VSC2 @ 18"	q	1259	1142	1182	1123	1079	1114	1082	1057	1084
		F	5.7+21R	6.9+14R	6.8+11R	7.3+8R	7.7+7R	7.4+6R	7.7+5R	7.9+5R	7.7+4R
	VSC2 @ 12"	q	1401	1366	1348	1336	1328	1322	1318	1314	1085
		F	4.8+22R	5.4+14R	5.7+11R	5.9+9R	6+7R	6.1+6R	6.1+5R	6.2+5R	6.2+4R
	VSC2 @ 8"	q	1567	1550	1541	1535	1532	1529	1527	1339	1085
		F	3.8+22R	4.3+14R	4.6+11R	4.7+9R	4.8+7R	4.9+6R	5+5R	5+5R	5+4R
	VSC2 @ 6"	q	1653	1644	1639	1636	1634	1633	1632	1339	1085
		F	3.3+22R	3.7+14R	4+11R	4.1+9R	4.2+7R	4.3+6R	4.4+5R	4.4+5R	4.4+4R
	VSC2 @ 4"	q	1732	1728	1727	1725	1725	1724	1695	1339	1085
		F	2.7+22R	3.2+15R	3.4+11R	3.5+9R	3.6+7R	3.7+6R	3.7+5R	3.8+5R	3.8+4R
16	VSC2 @ 24"	q	1318	1243	1203	1178	1161	1148	1139	1131	1125
		F	6.5+12R	7.1+8R	7.5+6R	7.7+5R	7.8+4R	7.9+3R	8+3R	8.1+2R	8.1+2R
	VSC2 @ 18"	q	1557	1433	1483	1418	1371	1412	1377	1349	1381
		F	5.1+12R	5.9+8R	5.7+6R	6.1+5R	6.4+4R	6.2+3R	6.4+3R	6.6+3R	6.5+2R
	VSC2 @ 12"	q	1712	1680	1664	1653	1646	1641	1637	1634	1514
		F	4.3+12R	4.7+8R	4.8+6R	5+5R	5+4R	5.1+3R	5.1+3R	5.2+3R	5.2+2R
	VSC2 @ 8"	q	1882	1868	1860	1856	1852	1850	1848	1847	1514
		F	3.4+12R	3.7+8R	3.9+6R	4+5R	4.1+4R	4.1+4R	4.1+3R	4.2+3R	4.2+2R
	VSC2 @ 6"	q	1965	1958	1954	1952	1950	1949	1948	1869	1514
		F	3+12R	3.3+8R	3.4+6R	3.5+5R	3.6+4R	3.6+4R	3.6+3R	3.6+3R	3.7+2R
	VSC2 @ 4"	q	2038	2035	2034	2033	2032	2032	2032	1869	1514
		F	2.5+12R	2.8+8R	2.9+6R	3+5R	3+4R	3.1+4R	3.1+3R	3.1+3R	3.2+2R

See footnotes on page 82.

Type PLN3™

- 32/7 Pneutek Fastener Pattern at Supports
SDK63 at Supports 0.155 to 0.250" thick
- Sidelaps Connected with PunchLok II Tool

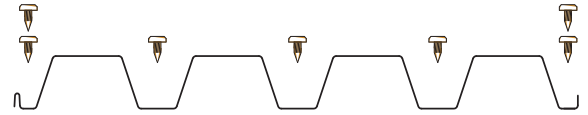

Allowable Diaphragm Shear Strength, q (plf) and Flexibility Factors, F ((in./lb)x10⁶)

DECK GAGE	SIDELAP ATTACHMENT	SPAN (ft-in.)									
		4'-0"	6'-0"	8'-0"	10'-0"	12'-0"	14'-0"	16'-0"	18'-0"	20'-0"	
22	VSC2 @ 24"	q	813	690	624	583	555	535	520	508	498
		F	10.4+67R	14+44R	16.2+32R	17.7+25R	18.7+21R	19.5+17R	20.2+15R	20.7+13R	21.1+12R
	VSC2 @ 18"	q	953	797	788	720	672	685	653	627	538
		F	8.5+68R	12+45R	12.8+33R	14.4+26R	15.6+22R	15.5+18R	16.3+16R	17+14R	16.8+13R
	VSC2 @ 12"	q	1073	981	931	899	878	862	841	665	538
		F	7.1+69R	9.5+46R	10.7+34R	11.5+27R	12.1+22R	12.5+19R	12.8+17R	13+15R	13.2+13R
	VSC2 @ 8"	q	*1260	1194	1158	1135	1120	1099	841	665	538
		F	5.4+70R	7.3+46R	8.3+35R	9+28R	9.4+23R	9.7+20R	9.9+17R	10.1+15R	10.2+14R
	VSC2 @ 6"	q	*1392	*1346	*1320	*1304	*1293	1099	841	665	538
		F	4.4+70R	6.1+47R	7+35R	7.6+28R	7.9+23R	8.2+20R	8.4+17R	8.5+15R	8.7+14R
	VSC2 @ 4"	q	*1554	*1530	*1517	*1509	*1496	1099	841	665	538
		F	3.2+70R	4.8+47R	5.6+35R	6.1+28R	6.4+23R	6.6+20R	6.8+18R	6.9+16R	7.1+14R
20	VSC2 @ 24"	q	1003	870	798	754	723	701	684	671	661
		F	9.3+42R	11.7+27R	13.1+20R	14+16R	14.7+13R	15.2+11R	15.5+9R	15.9+8R	16.1+7R
	VSC2 @ 18"	q	1182	1008	1011	932	876	898	859	829	708
		F	7.5+43R	9.9+28R	10.3+21R	11.4+17R	12.2+14R	12+12R	12.6+10R	13.1+9R	12.8+8R
	VSC2 @ 12"	q	1329	1238	1189	1157	1135	1120	1106	874	708
		F	6.4+44R	7.8+29R	8.6+22R	9.1+17R	9.5+14R	9.7+12R	9.9+11R	10+9R	10.1+8R
	VSC2 @ 8"	q	*1545	*1486	*1453	*1432	*1418	*1407	1106	874	708
		F	5+44R	6.2+29R	6.8+22R	7.2+18R	7.4+15R	7.6+12R	7.8+11R	7.9+10R	8+9R
	VSC2 @ 6"	q	*1688	*1648	*1627	*1613	*1604	*1444	1106	874	708
		F	4.1+44R	5.2+29R	5.8+22R	6.1+18R	6.4+15R	6.5+13R	6.6+11R	6.7+10R	6.8+9R
	VSC2 @ 4"	q	*1849	*1831	*1820	*1814	*1810	*1444	1106	874	708
		F	3.2+44R	4.2+30R	4.7+22R	5+18R	5.2+15R	5.4+13R	5.5+11R	5.6+10R	5.7+9R
18	VSC2 @ 24"	q	1352	1205	1125	1074	1040	1015	996	981	969
		F	6.6+21R	7.7+14R	8.3+10R	8.7+8R	8.9+7R	9.1+6R	9.3+5R	9.4+4R	9.5+4R
	VSC2 @ 18"	q	1596	1397	1418	1323	1255	1290	1243	1204	1085
		F	5.3+21R	6.5+14R	6.5+10R	7.1+8R	7.5+7R	7.3+6R	7.6+5R	7.8+5R	7.6+4R
	VSC2 @ 12"	q	1784	1696	1648	1617	1596	1580	1568	1339	1085
		F	4.6+21R	5.2+14R	5.5+11R	5.8+8R	5.9+7R	6+6R	6.1+5R	6.1+5R	6.2+4R
	VSC2 @ 8"	q	*2038	*1987	*1958	*1940	*1928	*1919	1695	1339	1085
		F	3.7+22R	4.2+14R	4.5+11R	4.7+9R	4.8+7R	4.9+6R	4.9+5R	5+5R	5+4R
	VSC2 @ 6"	q	*2190	*2159	*2141	*2131	*2123	*2118	1695	1339	1085
		F	3.2+22R	3.7+14R	3.9+11R	4.1+9R	4.2+7R	4.3+6R	4.3+5R	4.4+5R	4.4+4R
	VSC2 @ 4"	q	*2346	*2333	*2326	*2322	*2319	*2213	1695	1339	1085
		F	2.7+22R	3.1+15R	3.4+11R	3.5+9R	3.6+7R	3.7+6R	3.7+5R	3.8+5R	3.8+4R
16	VSC2 @ 24"	q	1678	1520	1434	1380	1343	1316	1295	1279	1266
		F	5.9+12R	6.6+7R	7.1+5R	7.3+4R	7.5+4R	7.7+3R	7.8+3R	7.8+2R	7.9+2R
	VSC2 @ 18"	q	1976	1758	1795	1688	1610	1657	1602	1557	1514
		F	4.8+12R	5.6+8R	5.6+6R	6+5R	6.3+4R	6.1+3R	6.3+3R	6.5+3R	6.4+2R
	VSC2 @ 12"	q	*2195	*2110	2062	2033	2012	1997	1986	1869	1514
		F	4.1+12R	4.5+8R	4.7+6R	4.9+5R	5+4R	5+3R	5.1+3R	5.1+3R	5.1+2R
	VSC2 @ 8"	q	*2473	*2426	*2401	*2385	*2374	*2366	*2360	1869	1514
		F	3.3+12R	3.7+8R	3.8+6R	3.9+5R	4+4R	4.1+3R	4.1+3R	4.1+3R	4.2+2R
	VSC2 @ 6"	q	*2628	*2601	*2587	*2578	*2572	*2567	*2365	1869	1514
		F	2.9+12R	3.2+8R	3.4+6R	3.5+5R	3.5+4R	3.6+4R	3.6+3R	3.6+3R	3.7+2R
	VSC2 @ 4"	q	*2780	*2769	*2764	*2760	*2758	*2756	*2365	1869	1514
		F	2.5+12R	2.8+8R	2.9+6R	3+5R	3+4R	3.1+4R	3.1+3R	3.1+3R	3.2+2R

1. For diaphragm shear strengths in bold and marked with *, the fastening pattern shall be increased at the building perimeter, chords, collectors to other shear transfer elements to two fasteners per rib (i.e. 32/10 pattern) or shall be limited to 1200 plf, 1400 plf, 1800 plf or 2100 plf for 22, 20, 18 or 16 gage steel deck, respectively. Bearing at supports shall allow for proper end distance and fastener spacing.
2. See additional footnotes on page 82.

Type PLN3™

- 32/5 Pneutek Fastener Pattern at Supports
K64 at Supports 0.187 to 0.312" thick
- Sidelaps Connected with PunchLok II Tool



Allowable Diaphragm Shear Strength, q (plf) and Flexibility Factors, F ((in./lb)x10⁶)

DECK GAGE	SIDELAP ATTACHMENT	SPAN (ft.-in.)									
		4'-0"	6'-0"	8'-0"	10'-0"	12'-0"	14'-0"	16'-0"	18'-0"	20'-0"	
22	VSC2 @ 24"	q	613	547	512	491	476	465	457	451	446
		F	13.1+67R	16.5+44R	18.4+32R	19.6+26R	20.5+21R	21.1+18R	21.6+16R	22+14R	22.4+12R
	VSC2 @ 18"	q	743	645	661	615	582	601	579	560	538
		F	10.1+69R	13.7+45R	14+34R	15.5+27R	16.7+22R	16.4+19R	17.2+16R	17.8+15R	17.4+13R
	VSC2 @ 12"	q	846	804	781	767	757	750	745	665	538
		F	8.2+69R	10.4+46R	11.5+34R	12.1+27R	12.6+23R	12.9+19R	13.2+17R	13.4+15R	13.5+14R
	VSC2 @ 8"	q	992	966	952	943	937	933	841	665	538
		F	6+70R	7.8+46R	8.7+35R	9.3+28R	9.6+23R	9.9+20R	10.1+17R	10.3+15R	10.4+14R
	VSC2 @ 6"	q	1083	1066	1058	1052	1048	1046	841	665	538
		F	4.7+70R	6.4+47R	7.2+35R	7.7+28R	8.1+23R	8.3+20R	8.5+17R	8.6+16R	8.8+14R
	VSC2 @ 4"	q	1179	1172	1168	1166	1164	1099	841	665	538
		F	3.4+70R	4.9+47R	5.7+35R	6.2+28R	6.5+23R	6.7+20R	6.9+18R	7+16R	7.1+14R
20	VSC2 @ 24"	q	815	734	691	665	646	633	623	616	609
		F	11.1+42R	13.2+28R	14.4+21R	15.2+16R	15.7+13R	16.1+11R	16.4+10R	16.7+9R	16.8+8R
	VSC2 @ 18"	q	988	865	889	831	789	815	786	762	708
		F	8.6+43R	11+28R	11+21R	12.1+17R	12.9+14R	12.5+12R	13.1+10R	13.5+9R	13.2+8R
	VSC2 @ 12"	q	1122	1072	1046	1029	1017	1009	1003	874	708
		F	7.1+44R	8.4+29R	9.1+22R	9.5+17R	9.8+14R	10+12R	10.1+11R	10.3+10R	10.3+9R
	VSC2 @ 8"	q	1304	1275	1259	1249	1243	1238	1106	874	708
		F	5.3+44R	6.4+29R	7+22R	7.4+18R	7.6+15R	7.8+13R	7.9+11R	8+10R	8+9R
	VSC2 @ 6"	q	1414	1396	1386	1381	1376	1373	1106	874	708
		F	4.4+44R	5.4+30R	5.9+22R	6.2+18R	6.5+15R	6.6+13R	6.7+11R	6.8+10R	6.9+9R
	VSC2 @ 4"	q	1526	1519	1515	1512	1511	1444	1106	874	708
		F	3.3+45R	4.3+30R	4.8+22R	5.1+18R	5.3+15R	5.4+13R	5.5+11R	5.6+10R	5.7+9R
18	VSC2 @ 24"	q	1183	1080	1025	991	967	950	938	928	920
		F	7.4+21R	8.3+14R	8.8+10R	9.1+8R	9.3+7R	9.4+6R	9.5+5R	9.6+4R	9.7+4R
	VSC2 @ 18"	q	1428	1268	1308	1230	1174	1213	1173	1140	1085
		F	5.7+21R	6.9+14R	6.8+11R	7.3+8R	7.7+7R	7.4+6R	7.7+5R	7.9+5R	7.7+4R
	VSC2 @ 12"	q	1611	1553	1522	1503	1489	1480	1472	1339	1085
		F	4.8+22R	5.4+14R	5.7+11R	5.9+9R	6+7R	6.1+6R	6.1+5R	6.2+5R	6.2+4R
	VSC2 @ 8"	q	1846	1815	1798	1787	1780	1774	1695	1339	1085
		F	3.8+22R	4.3+14R	4.6+11R	4.7+9R	4.8+7R	4.9+6R	5+5R	5+5R	5+4R
	VSC2 @ 6"	q	1980	1961	1951	1945	1941	1938	1695	1339	1085
		F	3.3+22R	3.7+14R	4+11R	4.1+9R	4.2+7R	4.3+6R	4.4+5R	4.4+5R	4.4+4R
	VSC2 @ 4"	q	2110	2102	2099	2096	2095	2093	1695	1339	1085
		F	2.7+22R	3.2+15R	3.4+11R	3.5+9R	3.6+7R	3.7+6R	3.7+5R	3.8+5R	3.8+4R
16	VSC2 @ 24"	q	1523	1405	1341	1301	1275	1255	1240	1229	1219
		F	6.5+12R	7.1+8R	7.5+6R	7.7+5R	7.8+4R	7.9+3R	8+3R	8.1+2R	8.1+2R
	VSC2 @ 18"	q	1832	1644	1699	1605	1538	1588	1539	1500	1514
		F	5.1+12R	5.9+8R	5.7+6R	6.1+5R	6.4+4R	6.2+3R	6.4+3R	6.6+3R	6.5+2R
	VSC2 @ 12"	q	2054	1992	1959	1938	1923	1913	1905	1869	1514
		F	4.3+12R	4.7+8R	4.8+6R	5+5R	5+4R	5.1+3R	5.1+3R	5.2+3R	5.2+2R
	VSC2 @ 8"	q	2327	2295	2277	2267	2259	2254	2250	1869	1514
		F	3.4+12R	3.7+8R	3.9+6R	4+5R	4.1+4R	4.1+4R	4.1+3R	4.2+3R	4.2+2R
	VSC2 @ 6"	q	2475	2457	2447	2441	2437	2434	2365	1869	1514
		F	3+12R	3.3+8R	3.4+6R	3.5+5R	3.6+4R	3.6+4R	3.6+3R	3.6+3R	3.7+2R
	VSC2 @ 4"	q	2614	2607	2604	2601	2600	2599	2365	1869	1514
		F	2.5+12R	2.8+8R	2.9+6R	3+5R	3+4R	3.1+4R	3.1+3R	3.1+3R	3.2+2R

See footnotes on page 82.

Type PLN3™

- 32/7 Pneutek Fastener Pattern at Supports
K64 at Supports 0.187 to 0.312" thick
- Sidelaps Connected with PunchLok II Tool

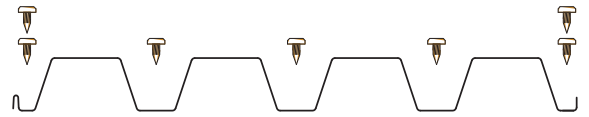

Allowable Diaphragm Shear Strength, q (plf) and Flexibility Factors, F ((in./lb)x10⁶)

DECK GAGE	SIDELAP ATTACHMENT	SPAN (ft-in.)									
		4'-0"	6'-0"	8'-0"	10'-0"	12'-0"	14'-0"	16'-0"	18'-0"	20'-0"	
22	VSC2 @ 24"	q	815	692	625	584	556	536	520	508	498
		F	10.4+67R	14+44R	16.2+32R	17.7+25R	18.7+21R	19.5+17R	20.2+15R	20.7+13R	21.1+12R
	VSC2 @ 18"	q	955	798	789	720	673	686	654	628	538
		F	8.5+68R	12+45R	12.8+33R	14.4+26R	15.6+22R	15.5+18R	16.3+16R	17+14R	16.8+13R
	VSC2 @ 12"	q	1075	983	932	901	879	863	841	665	538
		F	7.1+69R	9.5+46R	10.7+34R	11.5+27R	12.1+22R	12.5+19R	12.8+17R	13+15R	13.2+13R
	VSC2 @ 8"	q	*1262	1197	1160	1137	1121	1099	841	665	538
		F	5.4+70R	7.3+46R	8.3+35R	9+28R	9.4+23R	9.7+20R	9.9+17R	10.1+15R	10.2+14R
	VSC2 @ 6"	q	*1395	*1349	*1323	*1307	*1295	1099	841	665	538
		F	4.4+70R	6.1+47R	7+35R	7.6+28R	7.9+23R	8.2+20R	8.4+17R	8.5+15R	8.7+14R
VSC2 @ 4"	q	*1558	*1534	*1521	*1513	*1496	1099	841	665	538	
	F	3.2+70R	4.8+47R	5.6+35R	6.1+28R	6.4+23R	6.6+20R	6.8+18R	6.9+16R	7.1+14R	
20	VSC2 @ 24"	q	1076	922	839	787	752	726	707	692	679
		F	9.3+42R	11.7+27R	13.1+20R	14+16R	14.7+13R	15.2+11R	15.5+9R	15.9+8R	16.1+7R
	VSC2 @ 18"	q	1264	1065	1060	972	910	930	888	855	708
		F	7.5+43R	9.9+28R	10.3+21R	11.4+17R	12.2+14R	12+12R	12.6+10R	13.1+9R	12.8+8R
	VSC2 @ 12"	q	1423	1312	1251	1213	1186	1167	1106	874	708
		F	6.4+44R	7.8+29R	8.6+22R	9.1+17R	9.5+14R	9.7+12R	9.9+11R	10+9R	10.1+8R
	VSC2 @ 8"	q	*1665	1588	1546	1519	1501	1444	1106	874	708
		F	5+44R	6.2+29R	6.8+22R	7.2+18R	7.4+15R	7.6+12R	7.8+11R	7.9+10R	8+9R
	VSC2 @ 6"	q	*1831	*1778	*1749	*1731	*1718	1444	1106	874	708
		F	4.1+44R	5.2+29R	5.8+22R	6.1+18R	6.4+15R	6.5+13R	6.6+11R	6.7+10R	6.8+9R
VSC2 @ 4"	q	*2028	*2002	*1988	*1979	*1965	1444	1106	874	708	
	F	3.2+44R	4.2+30R	4.7+22R	5+18R	5.2+15R	5.4+13R	5.5+11R	5.6+10R	5.7+9R	
18	VSC2 @ 24"	q	1541	1341	1232	1165	1119	1085	1060	1040	1024
		F	6.6+21R	7.7+14R	8.3+10R	8.7+8R	8.9+7R	9.1+6R	9.3+5R	9.4+4R	9.5+4R
	VSC2 @ 18"	q	1817	1554	1560	1440	1355	1389	1331	1284	1085
		F	5.3+21R	6.5+14R	6.5+10R	7.1+8R	7.5+7R	7.3+6R	7.6+5R	7.8+5R	7.6+4R
	VSC2 @ 12"	q	2042	1907	1833	1786	1753	1730	1695	1339	1085
		F	4.6+21R	5.2+14R	5.5+11R	5.8+8R	5.9+7R	6+6R	6.1+5R	6.1+5R	6.2+4R
	VSC2 @ 8"	q	*2371	*2283	*2235	*2204	2183	2167	1695	1339	1085
		F	3.7+22R	4.2+14R	4.5+11R	4.7+9R	4.8+7R	4.9+6R	4.9+5R	5+5R	5+4R
	VSC2 @ 6"	q	*2586	*2528	*2496	*2476	*2463	*2213	1695	1339	1085
		F	3.2+22R	3.7+14R	3.9+11R	4.1+9R	4.2+7R	4.3+6R	4.3+5R	4.4+5R	4.4+4R
VSC2 @ 4"	q	*2826	*2799	*2785	*2776	*2769	*2213	1695	1339	1085	
	F	2.7+22R	3.1+15R	3.4+11R	3.5+9R	3.6+7R	3.7+6R	3.7+5R	3.8+5R	3.8+4R	
16	VSC2 @ 24"	q	1969	1733	1605	1525	1471	1431	1401	1377	1358
		F	5.9+12R	6.6+7R	7.1+5R	7.3+4R	7.5+4R	7.7+3R	7.8+3R	7.8+2R	7.9+2R
	VSC2 @ 18"	q	2325	2010	2030	1884	1779	1827	1755	1697	1514
		F	4.8+12R	5.6+8R	5.6+6R	6+5R	6.3+4R	6.1+3R	6.3+3R	6.5+3R	6.4+2R
	VSC2 @ 12"	q	2608	2457	2374	2321	2285	2259	2239	1869	1514
		F	4.1+12R	4.5+8R	4.7+6R	4.9+5R	5+4R	5+3R	5.1+3R	5.1+3R	5.1+2R
	VSC2 @ 8"	q	*3006	*2912	*2861	*2828	*2806	*2789	2365	1869	1514
		F	3.3+12R	3.7+8R	3.8+6R	3.9+5R	4+4R	4.1+3R	4.1+3R	4.1+3R	4.2+2R
	VSC2 @ 6"	q	*3254	*3195	*3163	*3143	*3129	*3089	2365	1869	1514
		F	2.9+12R	3.2+8R	3.4+6R	3.5+5R	3.5+4R	3.6+4R	3.6+3R	3.6+3R	3.7+2R
VSC2 @ 4"	q	*3522	*3496	*3482	*3473	*3467	*3089	2365	1869	1514	
	F	2.5+12R	2.8+8R	2.9+6R	3+5R	3+4R	3.1+4R	3.1+3R	3.1+3R	3.2+2R	

1. For diaphragm shear strengths in bold and marked with *, the fastening pattern shall be increased at the building perimeter, chords, collectors to other shear transfer elements to two fasteners per rib (i.e. 32/10 pattern) or shall be limited to 1200 plf, 1600 plf, 2200 plf or 2700 plf for 22, 20, 18 or 16 gage steel deck, respectively. Bearing at supports shall allow for proper end distance and fastener spacing.
2. See additional footnotes on page 82.

Type PLN3™

- 32/5 Pneutek Fastener Pattern at Supports
K66 at Supports 0.281" and thicker
- Sidelaps Connected with PunchLok II Tool

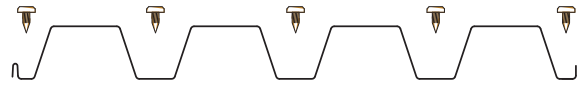

Allowable Diaphragm Shear Strength, q (plf) and Flexibility Factors, F ((in./lb)x10⁶)

DECK GAGE	SIDELAP ATTACHMENT	SPAN (ft.-in.)									
		4'-0"	6'-0"	8'-0"	10'-0"	12'-0"	14'-0"	16'-0"	18'-0"	20'-0"	
22	VSC2 @ 24"	q	633	561	523	500	484	473	464	457	452
		F	13.1+67R	16.5+44R	18.4+32R	19.6+26R	20.5+21R	21.1+18R	21.6+16R	22+14R	22.4+12R
	VSC2 @ 18"	q	766	662	676	627	593	612	588	569	538
		F	10.1+69R	13.7+45R	14+34R	15.5+27R	16.7+22R	16.4+19R	17.2+16R	17.8+15R	17.4+13R
	VSC2 @ 12"	q	875	828	802	786	775	767	761	665	538
		F	8.2+69R	10.4+46R	11.5+34R	12.1+27R	12.6+23R	12.9+19R	13.2+17R	13.4+15R	13.5+14R
	VSC2 @ 8"	q	1031	1001	985	975	968	963	841	665	538
		F	6+70R	7.8+46R	8.7+35R	9.3+28R	9.6+23R	9.9+20R	10.1+17R	10.3+15R	10.4+14R
	VSC2 @ 6"	q	1131	1112	1101	1095	1090	1087	841	665	538
		F	4.7+70R	6.4+47R	7.2+35R	7.7+28R	8.1+23R	8.3+20R	8.5+17R	8.6+16R	8.8+14R
	VSC2 @ 4"	q	1239	1231	1226	1223	1221	1099	841	665	538
		F	3.4+70R	4.9+47R	5.7+35R	6.2+28R	6.5+23R	6.7+20R	6.9+18R	7+16R	7.1+14R
20	VSC2 @ 24"	q	824	740	696	669	650	637	626	618	612
		F	11.1+42R	13.2+28R	14.4+21R	15.2+16R	15.7+13R	16.1+11R	16.4+10R	16.7+9R	16.8+8R
	VSC2 @ 18"	q	998	873	896	836	794	820	790	766	708
		F	8.6+43R	11+28R	11+21R	12.1+17R	12.9+14R	12.5+12R	13.1+10R	13.5+9R	13.2+8R
	VSC2 @ 12"	q	1134	1083	1055	1037	1026	1017	1010	874	708
		F	7.1+44R	8.4+29R	9.1+22R	9.5+17R	9.8+14R	10+12R	10.1+11R	10.3+10R	10.3+9R
	VSC2 @ 8"	q	1321	1290	1274	1263	1256	1251	1106	874	708
		F	5.3+44R	6.4+29R	7+22R	7.4+18R	7.6+15R	7.8+13R	7.9+11R	8+10R	8+9R
	VSC2 @ 6"	q	1434	1415	1405	1399	1395	1391	1106	874	708
		F	4.4+44R	5.4+30R	5.9+22R	6.2+18R	6.5+15R	6.6+13R	6.7+11R	6.8+10R	6.9+9R
	VSC2 @ 4"	q	1551	1543	1539	1536	1535	1444	1106	874	708
		F	3.3+45R	4.3+30R	4.8+22R	5.1+18R	5.3+15R	5.4+13R	5.5+11R	5.6+10R	5.7+9R
18	VSC2 @ 24"	q	1208	1098	1040	1004	979	961	948	937	929
		F	7.4+21R	8.3+14R	8.8+10R	9.1+8R	9.3+7R	9.4+6R	9.5+5R	9.6+4R	9.7+4R
	VSC2 @ 18"	q	1460	1292	1331	1249	1191	1230	1188	1155	1085
		F	5.7+21R	6.9+14R	6.8+11R	7.3+8R	7.7+7R	7.4+6R	7.7+5R	7.9+5R	7.7+4R
	VSC2 @ 12"	q	1650	1588	1554	1532	1518	1507	1499	1339	1085
		F	4.8+22R	5.4+14R	5.7+11R	5.9+9R	6+7R	6.1+6R	6.1+5R	6.2+5R	6.2+4R
	VSC2 @ 8"	q	1900	1865	1845	1834	1825	1819	1695	1339	1085
		F	3.8+22R	4.3+14R	4.6+11R	4.7+9R	4.8+7R	4.9+6R	5+5R	5+5R	5+4R
	VSC2 @ 6"	q	2043	2022	2011	2004	2000	1996	1695	1339	1085
		F	3.3+22R	3.7+14R	4+11R	4.1+9R	4.2+7R	4.3+6R	4.4+5R	4.4+5R	4.4+4R
	VSC2 @ 4"	q	2186	2177	2173	2170	2168	2167	1695	1339	1085
		F	2.7+22R	3.2+15R	3.4+11R	3.5+9R	3.6+7R	3.7+6R	3.7+5R	3.8+5R	3.8+4R
16	VSC2 @ 24"	q	1606	1467	1393	1347	1315	1292	1275	1262	1251
		F	6.5+12R	7.1+8R	7.5+6R	7.7+5R	7.8+4R	7.9+3R	8+3R	8.1+2R	8.1+2R
	VSC2 @ 18"	q	1939	1723	1778	1672	1596	1649	1594	1550	1514
		F	5.1+12R	5.9+8R	5.7+6R	6.1+5R	6.4+4R	6.2+3R	6.4+3R	6.6+3R	6.5+2R
	VSC2 @ 12"	q	2187	2109	2067	2041	2023	2010	2000	1869	1514
		F	4.3+12R	4.7+8R	4.8+6R	5+5R	5+4R	5.1+3R	5.1+3R	5.2+3R	5.2+2R
	VSC2 @ 8"	q	2505	2462	2439	2425	2415	2408	2365	1869	1514
		F	3.4+12R	3.7+8R	3.9+6R	4+5R	4.1+4R	4.1+4R	4.1+3R	4.2+3R	4.2+2R
	VSC2 @ 6"	q	2684	2660	2647	2638	2633	2629	2365	1869	1514
		F	3+12R	3.3+8R	3.4+6R	3.5+5R	3.6+4R	3.6+4R	3.6+3R	3.6+3R	3.7+2R
	VSC2 @ 4"	q	2860	2850	2845	2841	2839	2838	2365	1869	1514
		F	2.5+12R	2.8+8R	2.9+6R	3+5R	3+4R	3.1+4R	3.1+3R	3.1+3R	3.2+2R

See footnotes on page 82.

Type PLN3™

- 32/7 Pneutek Fastener Pattern at Supports
K66 at Supports 0.281" and thicker
- Sidelaps Connected with PunchLok II Tool

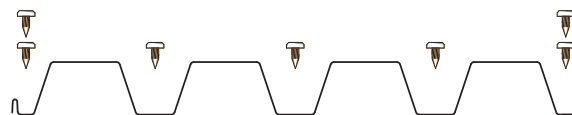

Allowable Diaphragm Shear Strength, q (plf) and Flexibility Factors, F ((in./lb)x10⁶)

DECK GAGE	SIDELAP ATTACHMENT		SPAN (ft-in.)								
			4'-0"	6'-0"	8'-0"	10'-0"	12'-0"	14'-0"	16'-0"	18'-0"	20'-0"
22	VSC2 @ 24"	q	847	714	642	598	568	546	529	516	506
		F	10.4+67R	14+44R	16.2+32R	17.7+25R	18.7+21R	19.5+17R	20.2+15R	20.7+13R	21.1+12R
	VSC2 @ 18"	q	989	822	809	736	686	698	665	638	538
		F	8.5+68R	12+45R	12.8+33R	14.4+26R	15.6+22R	15.5+18R	16.3+16R	17+14R	16.8+13R
	VSC2 @ 12"	q	1113	1012	956	922	898	880	841	665	538
		F	7.1+69R	9.5+46R	10.7+34R	11.5+27R	12.1+22R	12.5+19R	12.8+17R	13+15R	13.2+13R
	VSC2 @ 8"	q	*1310	1236	1195	1169	1151	1099	841	665	538
		F	5.4+70R	7.3+46R	8.3+35R	9+28R	9.4+23R	9.7+20R	9.9+17R	10.1+15R	10.2+14R
	VSC2 @ 6"	q	*1453	*1399	*1369	*1351	*1338	1099	841	665	538
		F	4.4+70R	6.1+47R	7+35R	7.6+28R	7.9+23R	8.2+20R	8.4+17R	8.5+15R	8.7+14R
	VSC2 @ 4"	q	*1631	*1603	*1587	*1577	*1496	1099	841	665	538
		F	3.2+70R	4.8+47R	5.6+35R	6.1+28R	6.4+23R	6.6+20R	6.8+18R	6.9+16R	7.1+14R
20	VSC2 @ 24"	q	1088	930	845	792	756	730	711	695	683
		F	9.3+42R	11.7+27R	13.1+20R	14+16R	14.7+13R	15.2+11R	15.5+9R	15.9+8R	16.1+7R
	VSC2 @ 18"	q	1278	1075	1069	979	916	936	893	859	708
		F	7.5+43R	9.9+28R	10.3+21R	11.4+17R	12.2+14R	12+12R	12.6+10R	13.1+9R	12.8+8R
	VSC2 @ 12"	q	1439	1324	1261	1222	1194	1175	1106	874	708
		F	6.4+44R	7.8+29R	8.6+22R	9.1+17R	9.5+14R	9.7+12R	9.9+11R	10+9R	10.1+8R
	VSC2 @ 8"	q	*1685	*1605	1561	1533	1514	1444	1106	874	708
		F	5+44R	6.2+29R	6.8+22R	7.2+18R	7.4+15R	7.6+12R	7.8+11R	7.9+10R	8+9R
	VSC2 @ 6"	q	*1855	*1800	*1770	*1750	*1737	1444	1106	874	708
		F	4.1+44R	5.2+29R	5.8+22R	6.1+18R	6.4+15R	6.5+13R	6.6+11R	6.7+10R	6.8+9R
	VSC2 @ 4"	q	*2058	*2031	*2016	*2006	*1965	1444	1106	874	708
		F	3.2+44R	4.2+30R	4.7+22R	5+18R	5.2+15R	5.4+13R	5.5+11R	5.6+10R	5.7+9R
18	VSC2 @ 24"	q	1579	1368	1253	1182	1134	1099	1072	1051	1034
		F	6.6+21R	7.7+14R	8.3+10R	8.7+8R	8.9+7R	9.1+6R	9.3+5R	9.4+4R	9.5+4R
	VSC2 @ 18"	q	1860	1584	1587	1462	1373	1407	1346	1298	1085
		F	5.3+21R	6.5+14R	6.5+10R	7.1+8R	7.5+7R	7.3+6R	7.6+5R	7.8+5R	7.6+4R
	VSC2 @ 12"	q	2092	1947	1867	1816	1781	1756	1695	1339	1085
		F	4.6+21R	5.2+14R	5.5+11R	5.8+8R	5.9+7R	6+6R	6.1+5R	6.1+5R	6.2+4R
	VSC2 @ 8"	q	*2435	*2339	*2286	*2252	*2229	*2212	1695	1339	1085
		F	3.7+22R	4.2+14R	4.5+11R	4.7+9R	4.8+7R	4.9+6R	4.9+5R	5+5R	5+4R
	VSC2 @ 6"	q	*2662	*2598	*2563	*2541	*2525	*2213	1695	1339	1085
		F	3.2+22R	3.7+14R	3.9+11R	4.1+9R	4.2+7R	4.3+6R	4.3+5R	4.4+5R	4.4+4R
	VSC2 @ 4"	q	*2921	*2890	*2874	*2864	*2856	*2213	1695	1339	1085
		F	2.7+22R	3.1+15R	3.4+11R	3.5+9R	3.6+7R	3.7+6R	3.7+5R	3.8+5R	3.8+4R
16	VSC2 @ 24"	q	2092	1821	1674	1583	1521	1475	1441	1414	1393
		F	5.9+12R	6.6+7R	7.1+5R	7.3+4R	7.5+4R	7.7+3R	7.8+3R	7.8+2R	7.9+2R
	VSC2 @ 18"	q	2466	2110	2120	1957	1842	1888	1809	1746	1514
		F	4.8+12R	5.6+8R	5.6+6R	6+5R	6.3+4R	6.1+3R	6.3+3R	6.5+3R	6.4+2R
	VSC2 @ 12"	q	2772	2590	2490	2426	2383	2351	2327	1869	1514
		F	4.1+12R	4.5+8R	4.7+6R	4.9+5R	5+4R	5+3R	5.1+3R	5.1+3R	5.1+2R
	VSC2 @ 8"	q	*3218	*3100	*3034	*2993	*2964	*2943	2365	1869	1514
		F	3.3+12R	3.7+8R	3.8+6R	3.9+5R	4+4R	4.1+3R	4.1+3R	4.1+3R	4.2+2R
	VSC2 @ 6"	q	*3508	*3430	*3388	*3361	*3342	*3089	2365	1869	1514
		F	2.9+12R	3.2+8R	3.4+6R	3.5+5R	3.5+4R	3.6+4R	3.6+3R	3.6+3R	3.7+2R
	VSC2 @ 4"	q	*3832	*3796	*3776	*3764	*3756	*3089	2365	1869	1514
		F	2.5+12R	2.8+8R	2.9+6R	3+5R	3+4R	3.1+4R	3.1+3R	3.1+3R	3.2+2R

1. For diaphragm shear strengths in bold and marked with *, the fastening pattern shall be increased at the building perimeter, chords, collectors to other shear transfer elements to two fasteners per rib (i.e. 32/10 pattern) or shall be limited to 1300 plf, 1600 plf, 2200 plf or 2600 plf for 22, 20, 18 or 16 gage steel deck, respectively. Bearing at supports shall allow for proper end distance and fastener spacing.
2. See additional footnotes on page 82.

Type PLN3™

- 32/5 Screw Pattern at Supports
#12 or #14 SDI Recognized Screws
to Supports 0.0385" and thicker
- Sidelaps Connected with PunchLok II Tool

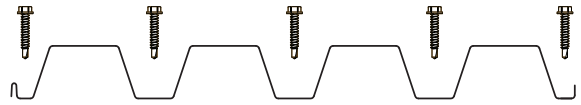

Allowable Diaphragm Shear Strength, q (plf) and Flexibility Factors, F ((in./lb)x10⁶)

DECK GAGE	SIDELAP ATTACHMENT	SPAN (ft.-in.)									
		2'-0"	4'-0"	6'-0"	8'-0"	10'-0"	12'-0"	14'-0"	16'-0"	18'-0"	
22	VSC2 @ 24"	q	641	548	500	474	458	447	439	433	428
		F	1.2+139R	8.7+68R	12.3+44R	14.5+32R	16.1+25R	17.3+20R	18.2+17R	18.9+15R	19.5+13R
	VSC2 @ 18"	q	799	662	587	605	569	543	561	542	527
		F	0.1+140R	7.3+68R	10.8+45R	11.8+33R	13.4+26R	14.7+21R	14.7+18R	15.6+16R	16.3+14R
	VSC2 @ 12"	q	799	747	720	705	696	690	685	681	665
		F	0.1+140R	6.3+69R	8.7+45R	10.1+34R	11+27R	11.6+22R	12+19R	12.4+17R	12.6+15R
	VSC2 @ 8"	q	886	857	842	834	829	825	823	821	665
		F	-0.6+140R	4.9+70R	7+46R	8+34R	8.7+27R	9.1+23R	9.5+20R	9.7+17R	9.9+15R
	VSC2 @ 6"	q	937	920	911	906	904	902	900	841	665
		F	-1.1+140R	4.1+70R	5.9+46R	6.8+35R	7.4+28R	7.8+23R	8.1+20R	8.3+17R	8.4+15R
VSC2 @ 4"	q	989	981	978	976	975	974	974	841	665	
	F	-1.8+141R	3+70R	4.7+47R	5.5+35R	6+28R	6.3+23R	6.6+20R	6.8+17R	6.9+16R	
20	VSC2 @ 24"	q	808	706	653	624	606	594	585	579	574
		F	2.8+88R	8+42R	10.5+27R	12+20R	13+16R	13.7+13R	14.3+11R	14.8+9R	15.1+8R
	VSC2 @ 18"	q	999	847	763	789	746	715	739	717	699
		F	1.8+88R	6.7+43R	9.1+28R	9.7+21R	10.8+16R	11.6+13R	11.5+12R	12.1+10R	12.6+9R
	VSC2 @ 12"	q	999	948	921	906	897	891	887	883	874
		F	1.8+88R	5.8+44R	7.4+29R	8.2+21R	8.8+17R	9.2+14R	9.4+12R	9.7+11R	9.8+9R
	VSC2 @ 8"	q	1097	1070	1057	1049	1044	1041	1039	1037	874
		F	1.1+89R	4.7+44R	5.9+29R	6.6+22R	7+17R	7.3+14R	7.5+12R	7.6+11R	7.8+10R
	VSC2 @ 6"	q	1151	1136	1128	1124	1122	1120	1119	1106	874
		F	0.7+89R	4+44R	5.1+29R	5.7+22R	6+18R	6.3+15R	6.5+13R	6.6+11R	6.7+10R
VSC2 @ 4"	q	1203	1197	1194	1193	1192	1191	1190	1106	874	
	F	0.1+89R	3.1+44R	4.2+30R	4.7+22R	5+18R	5.2+15R	5.4+13R	5.5+11R	5.6+10R	
18	VSC2 @ 24"	q	1133	1012	948	914	893	878	868	860	853
		F	3.4+43R	6+21R	7.2+13R	7.9+10R	8.3+8R	8.6+6R	8.8+5R	9+5R	9.1+4R
	VSC2 @ 18"	q	1385	1203	1099	1137	1084	1045	1077	1049	1026
		F	2.4+43R	5+21R	6.2+14R	6.3+10R	6.8+8R	7.3+7R	7.1+6R	7.4+5R	7.6+4R
	VSC2 @ 12"	q	1385	1331	1302	1287	1277	1271	1266	1262	1259
		F	2.4+43R	4.3+21R	5+14R	5.4+11R	5.6+8R	5.8+7R	5.9+6R	6+5R	6.1+5R
	VSC2 @ 8"	q	1503	1476	1463	1456	1451	1448	1446	1444	1339
		F	1.9+43R	3.6+22R	4.1+14R	4.4+11R	4.6+9R	4.7+7R	4.8+6R	4.9+5R	4.9+5R
	VSC2 @ 6"	q	1564	1549	1542	1538	1536	1535	1533	1533	1339
		F	1.6+43R	3.1+22R	3.6+14R	3.9+11R	4.1+9R	4.2+7R	4.3+6R	4.3+5R	4.4+5R
VSC2 @ 4"	q	1620	1615	1612	1611	1610	1609	1609	1609	1339	
	F	1.2+44R	2.6+22R	3.1+15R	3.4+11R	3.5+9R	3.6+7R	3.7+6R	3.7+5R	3.8+5R	
16	VSC2 @ 24"	q	1456	1315	1241	1201	1176	1159	1147	1138	1130
		F	3.5+24R	5.4+11R	6.2+7R	6.7+5R	7+4R	7.3+3R	7.4+3R	7.6+3R	7.7+2R
	VSC2 @ 18"	q	1767	1554	1430	1480	1416	1369	1410	1375	1347
		F	2.7+24R	4.5+12R	5.4+8R	5.4+6R	5.8+5R	6.1+4R	6+3R	6.2+3R	6.4+2R
	VSC2 @ 12"	q	1767	1708	1677	1660	1650	1642	1637	1633	1630
		F	2.7+24R	3.9+12R	4.4+8R	4.6+6R	4.8+5R	4.9+4R	5+3R	5+3R	5.1+3R
	VSC2 @ 8"	q	1905	1877	1863	1856	1851	1848	1845	1844	1842
		F	2.2+25R	3.3+12R	3.6+8R	3.8+6R	3.9+5R	4+4R	4+3R	4.1+3R	4.1+3R
	VSC2 @ 6"	q	1974	1960	1952	1948	1946	1944	1943	1942	1869
		F	1.9+25R	2.9+12R	3.2+8R	3.4+6R	3.4+5R	3.5+4R	3.6+4R	3.6+3R	3.6+3R
VSC2 @ 4"	q	2037	2032	2029	2028	2027	2026	2026	2025	1869	
	F	1.6+25R	2.5+12R	2.7+8R	2.9+6R	3+5R	3+4R	3.1+4R	3.1+3R	3.1+3R	

See footnotes on page 82.

Type PLN3™

- 32/7 Screw Pattern at Supports
#12 or #14 SDI Recognized Screws
to Supports 0.0385" and thicker
- Sidelaps Connected with PunchLok II Tool

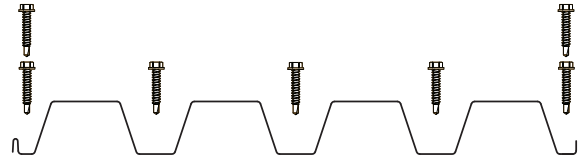

Allowable Diaphragm Shear Strength, q (plf) and Flexibility Factors, F ((in./lb)x10⁶)

DECK GAGE	SIDELAP ATTACHMENT	SPAN (ft-in.)									
		2'-0"	4'-0"	6'-0"	8'-0"	10'-0"	12'-0"	14'-0"	16'-0"	18'-0"	
22	VSC2 @ 24"	q	889	714	621	570	539	517	501	490	480
		F	-0.6+140R	6.3+68R	9.6+44R	11.9+32R	13.5+25R	14.7+20R	15.7+17R	16.6+14R	17.3+12R
	VSC2 @ 18"	q	1062	842	719	722	666	626	642	615	593
		F	-1.1+140R	5.5+69R	8.8+45R	10.1+33R	11.7+26R	12.9+21R	13.2+18R	14.1+15R	14.8+13R
	VSC2 @ 12"	q	1062	947	883	848	826	811	800	792	665
		F	-1.1+140R	4.9+69R	7.5+45R	8.9+34R	9.9+27R	10.6+22R	11.1+19R	11.5+16R	11.9+14R
	VSC2 @ 8"	q	*1176	*1100	*1059	*1036	*1021	*1011	*1004	841	665
		F	-1.5+140R	4.1+70R	6.2+46R	7.4+34R	8.1+27R	8.6+23R	9+19R	9.3+17R	9.5+15R
	VSC2 @ 6"	q	*1251	*1201	*1173	*1158	*1149	*1142	*1099	841	665
		F	-1.8+140R	3.5+70R	5.4+46R	6.4+35R	7+28R	7.5+23R	7.8+20R	8+17R	8.2+15R
	VSC2 @ 4"	q	*1338	*1314	*1301	*1294	*1290	*1287	*1099	841	665
		F	-2.2+141R	2.7+70R	4.4+47R	5.3+35R	5.8+28R	6.2+23R	6.4+20R	6.6+17R	6.8+15R
20	VSC2 @ 24"	q	1107	910	804	746	710	686	668	654	643
		F	1.4+88R	6.2+43R	8.6+28R	10.1+20R	11.2+15R	12.1+13R	12.7+10R	13.3+9R	13.7+8R
	VSC2 @ 18"	q	*1325	1075	932	943	876	829	851	818	792
		F	0.9+88R	5.4+43R	7.7+28R	8.5+21R	9.6+16R	10.5+13R	10.6+11R	11.2+10R	11.7+8R
	VSC2 @ 12"	q	*1325	*1205	1138	1101	1078	1062	1050	1041	874
		F	0.9+88R	4.9+44R	6.5+29R	7.5+21R	8.1+17R	8.6+14R	8.9+12R	9.2+10R	9.4+9R
	VSC2 @ 8"	q	*1459	*1385	*1345	*1322	*1308	1298	1291	1106	874
		F	0.5+89R	4.1+44R	5.5+29R	6.2+22R	6.7+17R	7+14R	7.2+12R	7.4+11R	7.6+9R
	VSC2 @ 6"	q	*1544	*1497	*1471	*1457	*1449	*1443	*1438	1106	874
		F	0.2+89R	3.6+44R	4.8+29R	5.4+22R	5.8+17R	6.1+15R	6.3+12R	6.4+11R	6.6+10R
	VSC2 @ 4"	q	*1637	*1615	*1604	*1598	*1594	*1592	*1444	1106	874
		F	-0.2+89R	2.9+44R	4+30R	4.6+22R	4.9+18R	5.1+15R	5.3+13R	5.4+11R	5.5+10R
18	VSC2 @ 24"	q	1534	1293	1161	1090	1045	1014	991	974	961
		F	2.5+43R	5.1+21R	6.3+13R	7.1+10R	7.6+8R	7.9+6R	8.2+5R	8.4+4R	8.6+4R
	VSC2 @ 18"	q	*1836	1525	1345	1370	1283	1220	1255	1211	1175
		F	1.9+43R	4.4+21R	5.6+14R	5.9+10R	6.4+8R	6.8+7R	6.8+6R	7.1+5R	7.3+4R
	VSC2 @ 12"	q	*1836	1700	1625	1584	1557	1539	1526	1516	1339
		F	1.9+43R	3.9+21R	4.7+14R	5.1+10R	5.4+8R	5.6+7R	5.7+6R	5.8+5R	5.9+5R
	VSC2 @ 8"	q	*2007	*1929	*1887	*1864	*1849	*1839	*1831	1695	1339
		F	1.6+43R	3.3+21R	4+14R	4.3+11R	4.5+9R	4.6+7R	4.7+6R	4.8+5R	4.9+5R
	VSC2 @ 6"	q	*2109	*2062	*2037	*2023	*2015	*2009	*2004	1695	1339
		F	1.4+43R	3+22R	3.5+14R	3.8+11R	4+9R	4.1+7R	4.2+6R	4.3+5R	4.3+5R
	VSC2 @ 4"	q	*2215	*2195	*2185	*2179	*2176	*2174	*2172	1695	1339
		F	1.1+44R	2.6+22R	3.1+14R	3.3+11R	3.5+9R	3.6+7R	3.7+6R	3.7+5R	3.7+5R
16	VSC2 @ 24"	q	1962	1675	1518	1432	1378	1341	1314	1294	1278
		F	2.8+24R	4.6+12R	5.5+7R	6.1+5R	6.5+4R	6.7+3R	6.9+3R	7.1+2R	7.3+2R
	VSC2 @ 18"	q	*2344	1972	1755	1792	1686	1608	1655	1600	1555
		F	2.3+24R	4+12R	4.9+8R	5+6R	5.5+4R	5.8+4R	5.7+3R	6+3R	6.1+2R
	VSC2 @ 12"	q	*2344	*2190	*2105	2059	2029	2009	1994	1982	1869
		F	2.3+24R	3.6+12R	4.1+8R	4.4+6R	4.6+5R	4.7+4R	4.8+3R	4.9+3R	4.9+3R
	VSC2 @ 8"	q	*2551	*2466	*2421	*2395	*2379	*2368	*2361	*2354	1869
		F	2+25R	3.1+12R	3.5+8R	3.7+6R	3.8+5R	3.9+4R	4+3R	4+3R	4.1+3R
	VSC2 @ 6"	q	*2671	*2621	*2595	*2580	*2571	*2565	*2561	*2365	1869
		F	1.8+25R	2.8+12R	3.1+8R	3.3+6R	3.4+5R	3.5+4R	3.5+3R	3.6+3R	3.6+3R
	VSC2 @ 4"	q	*2793	*2772	*2761	*2756	*2752	*2750	*2748	*2365	1869
		F	1.5+25R	2.4+12R	2.7+8R	2.9+6R	2.9+5R	3+4R	3.1+4R	3.1+3R	3.1+3R

1. For diaphragm shear strengths in bold and marked with *, the fastening pattern shall be increased at the building perimeter, chords, collectors to other shear transfer elements to two fasteners per rib (i.e. 32/10 pattern) or shall be limited to 1000 plf, 1200 plf, 1700 plf or 2100 plf for 22, 20, 18 or 16 gage steel deck, respectively. Bearing at supports shall allow for proper end distance and fastener spacing.
2. See additional footnotes on page 82.

Type HSN3™

- 32/5 Weld Pattern at Supports
- Sidelaps Connected with Button Punch or 1½" Top Seam Weld

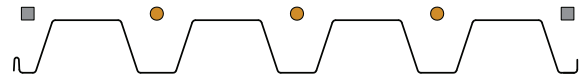

Allowable Diaphragm Shear Strength, q (plf) and Flexibility Factors, F ((in./lb)x10⁶)

DECK GAGE	SIDELAP ATTACHMENT	SPAN (ft.-in.)									
		4'-0"	6'-0"	8'-0"	10'-0"	12'-0"	14'-0"	16'-0"	18'-0"	20'-0"	
22	BP @ 24"	q	287	201	160	135	119	107	98	91	85
		F	11.6+66R	18+40R	23.4+26R	28.1+18R	32.3+12R	36.2+7R	39.8+3R	43.1+0R	46.2-2R
	BP @ 12"	q	322	237	196	171	154	143	134	127	121
		F	10.7+66R	16.3+41R	20.5+28R	24.1+20R	27.1+15R	29.7+11R	32+8R	34.1+6R	35.9+4R
	TSW @ 24"	q	685	600	559	534	515	502	493	485	479
		F	3.7+70R	5.5+46R	6.5+35R	7+28R	7.4+23R	7.7+20R	7.9+17R	8.1+15R	8.2+14R
	TSW @ 18"	q	849	721	736	679	638	660	632	610	538
		F	2.8+70R	4.7+47R	5.3+35R	5.9+28R	6.4+23R	6.5+20R	6.8+17R	7+16R	7+14R
	TSW @ 12"	q	987	924	891	870	856	846	838	665	538
		F	2.3+70R	3.8+47R	4.6+35R	5.1+28R	5.4+23R	5.6+20R	5.8+18R	5.9+16R	6+14R
	TSW @ 6"	q	1354	1323	1306	1296	1289	1099	841	665	538
		F	1.3+71R	2.8+47R	3.5+35R	4+28R	4.3+24R	4.5+20R	4.6+18R	4.8+16R	4.9+14R
20	BP @ 24"	q	418	290	230	195	171	154	141	131	123
		F	11.4+40R	16.9+23R	21.6+14R	25.7+8R	29.5+4R	33+1R	36.2-2R	39.2-4R	42-6R
	BP @ 12"	q	470	341	282	246	222	205	193	183	175
		F	10.6+41R	15.3+24R	19+16R	22.1+11R	24.8+7R	27.1+4R	29.2+2R	31+1R	32.6+0R
	TSW @ 24"	q	909	792	732	694	669	651	637	626	618
		F	4.3+44R	5.5+29R	6.2+22R	6.6+17R	6.8+15R	7+12R	7.2+11R	7.3+10R	7.4+9R
	TSW @ 18"	q	1112	941	956	879	826	852	816	786	708
		F	3.4+44R	4.8+29R	5+22R	5.6+18R	5.9+15R	5.9+13R	6.1+11R	6.3+10R	6.2+9R
	TSW @ 12"	q	1287	1200	1153	1124	1105	1090	1080	874	708
		F	2.9+44R	3.9+30R	4.4+22R	4.8+18R	5+15R	5.1+13R	5.2+11R	5.3+10R	5.4+9R
	TSW @ 6"	q	1756	1712	1688	1674	1664	1444	1106	874	708
		F	2.1+45R	3+30R	3.5+22R	3.8+18R	3.9+15R	4.1+13R	4.2+11R	4.3+10R	4.3+9R
18	BP @ 24"	q	748	513	407	344	302	272	249	232	218
		F	10.5+18R	14.9+9R	18.8+4R	22.3+0R	25.5-2R	28.5-4R	31.2-6R	33.8-7R	36.2-8R
	BP @ 12"	q	839	604	499	436	394	363	341	323	309
		F	9.8+18R	13.5+10R	16.5+5R	19.1+2R	21.4+0R	23.3-1R	25.1-2R	26.7-3R	28.1-4R
	TSW @ 24"	q	1419	1222	1119	1055	1012	981	958	940	925
		F	4.3+21R	5+14R	5.4+11R	5.7+8R	5.8+7R	5.9+6R	6+5R	6.1+5R	6.2+4R
	TSW @ 18"	q	1713	1439	1448	1327	1244	1278	1221	1176	1085
		F	3.6+22R	4.4+14R	4.5+11R	4.8+9R	5+7R	5+6R	5.1+5R	5.3+5R	5.2+4R
	TSW @ 12"	q	1970	1820	1740	1690	1656	1632	1613	1339	1085
		F	3.1+22R	3.7+14R	3.9+11R	4.1+9R	4.2+7R	4.3+6R	4.3+5R	4.4+5R	4.4+4R
	TSW @ 6"	q	2666	2589	2547	2521	2503	2213	1695	1339	1085
		F	2.4+22R	2.9+15R	3.1+11R	3.2+9R	3.3+7R	3.4+6R	3.4+5R	3.5+5R	3.5+4R
16	BP @ 24"	q	970	667	536	458	405	368	340	318	300
		F	9.6+9R	13.3+3R	16.7+0R	19.8-3R	22.7-4R	25.3-6R	27.8-7R	30-8R	32.2-9R
	BP @ 12"	q	1113	810	679	601	548	511	483	461	443
		F	8.9+9R	12.1+4R	14.7+1R	17-1R	19-2R	20.7-3R	22.3-4R	23.7-4R	24.9-5R
	TSW @ 24"	q	1834	1593	1466	1388	1335	1297	1268	1245	1227
		F	4+12R	4.5+8R	4.8+6R	5+5R	5.1+4R	5.2+3R	5.2+3R	5.3+3R	5.3+2R
	TSW @ 18"	q	2223	1879	1901	1748	1641	1690	1616	1558	1514
		F	3.3+12R	3.9+8R	3.9+6R	4.2+5R	4.4+4R	4.3+3R	4.4+3R	4.5+3R	4.5+2R
	TSW @ 12"	q	2556	2377	2281	2221	2181	2151	2129	1869	1514
		F	3+12R	3.3+8R	3.5+6R	3.6+5R	3.6+4R	3.7+3R	3.7+3R	3.8+3R	3.8+2R
	TSW @ 6"	q	3435	3347	3299	3270	3249	3089	2365	1869	1514
		F	2.3+12R	2.6+8R	2.7+6R	2.8+5R	2.8+4R	2.9+4R	2.9+3R	2.9+3R	3+2R

See footnotes on page 82.

Type HSN3™ -NS

- 32/5 Screw Pattern at Supports
#12 or #14 SDI Recognized Screws
to Supports 0.0385" and thicker
- Sidelaps Connected with #10 Screws

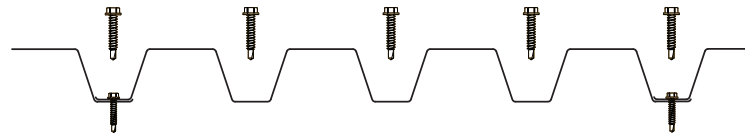

Allowable Diaphragm Shear Strength, q (plf) and Flexibility Factors, F ((in./lb)x10⁶)

DECK GAGE	SIDELAP ATTACHMENT	SPAN (ft-in.)									
		2'-0"	4'-0"	6'-0"	8'-0"	10'-0"	12'-0"	14'-0"	16'-0"	18'-0"	
22	#10 @ 24"	q	434	312	247	214	195	182	173	166	160
		F	0.5+140R	7.1+69R	9.8+45R	11.4+33R	12.4+26R	13.2+22R	13.7+19R	14.1+16R	14.5+14R
	#10 @ 18"	q	501	360	286	272	242	221	223	210	200
		F	-0.7+140R	5.6+69R	8.4+46R	9.1+34R	10.2+27R	11.1+22R	11.1+19R	11.6+17R	12.1+15R
	#10 @ 12"	q	501	401	348	320	302	290	281	274	269
		F	-0.7+140R	4.7+70R	6.7+46R	7.7+35R	8.3+28R	8.8+23R	9.1+20R	9.3+17R	9.5+15R
	#10 @ 8"	q	556	474	430	406	391	380	373	367	362
		F	-1.4+141R	3.6+70R	5.3+47R	6.2+35R	6.7+28R	7.1+23R	7.3+20R	7.5+17R	7.7+15R
	#10 @ 6"	q	601	534	498	478	465	456	450	445	442
		F	-1.9+141R	2.9+70R	4.5+47R	5.3+35R	5.8+28R	6.1+23R	6.4+20R	6.5+18R	6.7+16R
	#10 @ 4"	q	666	623	599	585	577	571	567	564	561
		F	-2.5+141R	2.1+70R	3.6+47R	4.4+35R	4.9+28R	5.2+23R	5.4+20R	5.6+18R	5.7+16R
20	#10 @ 24"	q	529	389	310	271	248	232	221	213	206
		F	2.5+88R	7.3+43R	9.4+28R	10.6+21R	11.5+16R	12.1+13R	12.5+11R	12.8+10R	13.1+9R
	#10 @ 18"	q	615	447	359	343	308	283	285	269	256
		F	1.4+88R	6+43R	8.1+28R	8.5+21R	9.5+17R	10.2+14R	10.1+12R	10.6+10R	11+9R
	#10 @ 12"	q	615	500	438	405	384	370	360	352	346
		F	1.4+88R	5.1+44R	6.5+29R	7.3+22R	7.7+17R	8.1+14R	8.3+12R	8.5+11R	8.6+10R
	#10 @ 8"	q	684	592	541	514	496	484	476	469	464
		F	0.8+89R	4.1+44R	5.3+29R	5.9+22R	6.2+18R	6.5+15R	6.7+13R	6.8+11R	6.9+10R
	#10 @ 6"	q	739	665	625	603	589	579	572	566	562
		F	0.3+89R	3.5+44R	4.5+30R	5.1+22R	5.4+18R	5.6+15R	5.8+13R	5.9+11R	6+10R
	#10 @ 4"	q	818	771	745	731	722	716	711	708	705
		F	-0.2+89R	2.8+45R	3.8+30R	4.3+22R	4.6+18R	4.8+15R	4.9+13R	5+11R	5.1+10R
18	#10 @ 24"	q	724	542	444	392	361	341	326	315	306
		F	3.8+42R	6.9+20R	8.4+13R	9.3+9R	9.9+7R	10.4+6R	10.7+5R	11+4R	11.2+4R
	#10 @ 18"	q	849	628	511	496	447	414	418	397	379
		F	2.9+43R	5.8+21R	7.3+13R	7.5+10R	8.2+8R	8.7+6R	8.6+5R	9+5R	9.3+4R
	#10 @ 12"	q	849	706	629	587	560	542	529	519	512
		F	2.9+43R	5.1+21R	5.9+14R	6.4+10R	6.7+8R	6.9+7R	7+6R	7.1+5R	7.2+4R
	#10 @ 8"	q	947	836	775	742	721	706	696	688	682
		F	2.3+43R	4.2+21R	4.8+14R	5.2+11R	5.4+8R	5.5+7R	5.6+6R	5.7+5R	5.8+5R
	#10 @ 6"	q	1021	936	889	863	847	836	828	821	817
		F	1.9+43R	3.6+22R	4.2+14R	4.5+11R	4.7+9R	4.8+7R	4.9+6R	4.9+5R	5+5R
	#10 @ 4"	q	1123	1072	1045	1030	1020	1013	1008	1005	1002
		F	1.5+43R	3+22R	3.5+14R	3.8+11R	3.9+9R	4+7R	4.1+6R	4.2+5R	4.2+5R
16	#10 @ 24"	q	926	705	588	526	487	461	443	428	417
		F	4+24R	6.3+11R	7.5+7R	8.3+5R	8.8+4R	9.1+3R	9.4+2R	9.6+2R	9.8+2R
	#10 @ 18"	q	1094	822	676	662	600	557	566	538	515
		F	3.2+24R	5.4+12R	6.5+7R	6.6+5R	7.2+4R	7.7+3R	7.5+3R	7.9+2R	8.1+2R
	#10 @ 12"	q	1094	925	834	784	753	731	716	704	695
		F	3.2+24R	4.7+12R	5.3+8R	5.7+6R	5.9+5R	6+4R	6.1+3R	6.2+3R	6.3+2R
	#10 @ 8"	q	1220	1094	1025	986	962	946	934	925	917
		F	2.7+24R	3.9+12R	4.3+8R	4.6+6R	4.7+5R	4.8+4R	4.9+3R	4.9+3R	5+3R
	#10 @ 6"	q	1314	1220	1168	1140	1122	1109	1100	1093	1088
		F	2.3+25R	3.4+12R	3.8+8R	4+6R	4.1+5R	4.2+4R	4.2+3R	4.3+3R	4.3+3R
	#10 @ 4"	q	1438	1384	1355	1339	1329	1322	1317	1313	1310
		F	1.9+25R	2.8+12R	3.2+8R	3.3+6R	3.4+5R	3.5+4R	3.5+4R	3.6+3R	3.6+3R

See footnotes on page 82.

Type HSN3™ -NS

- 32/7 Screw Pattern at Supports
#12 or #14 SDI Recognized Screws
to Supports 0.0385" and thicker
- Sidelaps Connected with #10 Screws

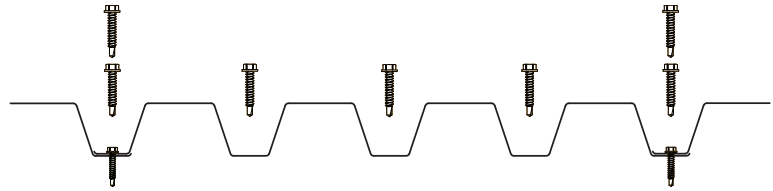

Allowable Diaphragm Shear Strength, q (plf) and Flexibility Factors, F ((in./lb)x10⁶)

DECK GAGE	SIDELAP ATTACHMENT	SPAN (ft.-in.)									
		2'-0"	4'-0"	6'-0"	8'-0"	10'-0"	12'-0"	14'-0"	16'-0"	18'-0"	
22	VSC2 @ 24"	q	643	461	345	288	254	231	215	203	193
		F	-0.9+140R	5.4+69R	8.2+45R	9.8+33R	11+26R	11.8+21R	12.5+18R	13+16R	13.4+14R
	VSC2 @ 18"	q	697	503	384	347	301	270	265	247	232
		F	-1.5+140R	4.5+69R	7.2+46R	8.2+34R	9.4+27R	10.2+22R	10.4+19R	10.9+16R	11.4+14R
	VSC2 @ 12"	q	697	542	451	401	369	347	331	318	309
		F	-1.5+140R	3.9+70R	6+46R	7.1+34R	7.8+27R	8.3+23R	8.7+19R	9+17R	9.2+15R
	VSC2 @ 8"	q	742	610	532	488	460	440	426	415	406
		F	-2+141R	3.1+70R	4.9+46R	5.9+35R	6.4+28R	6.8+23R	7.1+20R	7.3+17R	7.5+15R
	VSC2 @ 6"	q	780	669	602	564	539	522	510	500	493
		F	-2.3+141R	2.6+70R	4.3+47R	5.1+35R	5.6+28R	6+23R	6.3+20R	6.4+17R	6.6+15R
	VSC2 @ 4"	q	841	761	713	685	667	655	645	638	633
		F	-2.7+141R	1.9+70R	3.5+47R	4.3+35R	4.8+28R	5.1+23R	5.3+20R	5.5+18R	5.6+16R
20	VSC2 @ 24"	q	779	565	428	359	318	291	272	257	246
		F	1.2+88R	5.8+43R	7.9+28R	9.2+20R	10.1+16R	10.8+13R	11.4+11R	11.8+9R	12.1+8R
	VSC2 @ 18"	q	848	618	479	437	380	343	338	315	297
		F	0.7+89R	5+43R	7.1+28R	7.7+21R	8.7+17R	9.4+14R	9.4+12R	9.9+10R	10.3+9R
	VSC2 @ 12"	q	848	667	562	502	465	439	420	405	394
		F	0.7+89R	4.4+44R	5.9+29R	6.8+21R	7.3+17R	7.6+14R	7.9+12R	8.1+11R	8.3+9R
	VSC2 @ 8"	q	905	754	664	613	581	558	542	529	519
		F	0.3+89R	3.7+44R	4.9+29R	5.6+22R	6+17R	6.3+15R	6.5+12R	6.6+11R	6.8+10R
	VSC2 @ 6"	q	953	827	752	709	681	662	647	636	628
		F	0+89R	3.2+44R	4.3+29R	4.9+22R	5.3+18R	5.5+15R	5.7+13R	5.8+11R	5.9+10R
	VSC2 @ 4"	q	1026	939	886	856	837	823	813	805	799
		F	-0.4+89R	2.6+44R	3.7+30R	4.2+22R	4.5+18R	4.7+15R	4.9+13R	5+11R	5.1+10R
18	VSC2 @ 24"	q	1052	774	601	510	456	419	393	374	359
		F	2.7+43R	5.6+20R	7.1+13R	8.1+9R	8.8+7R	9.3+6R	9.7+5R	10+4R	10.3+3R
	VSC2 @ 18"	q	1154	854	677	625	550	498	495	463	438
		F	2.2+43R	4.9+21R	6.4+13R	6.8+10R	7.5+8R	8+6R	8+5R	8.4+4R	8.8+4R
	VSC2 @ 12"	q	1154	926	792	717	669	635	611	593	578
		F	2.2+43R	4.4+21R	5.4+14R	5.9+10R	6.3+8R	6.5+7R	6.7+6R	6.9+5R	7+4R
	VSC2 @ 8"	q	1236	1051	941	878	837	809	789	773	761
		F	1.9+43R	3.8+21R	4.5+14R	4.9+10R	5.2+8R	5.4+7R	5.5+6R	5.6+5R	5.6+5R
	VSC2 @ 6"	q	1302	1153	1063	1012	978	955	938	925	915
		F	1.6+43R	3.4+21R	4+14R	4.3+11R	4.6+9R	4.7+7R	4.8+6R	4.9+5R	4.9+5R
	VSC2 @ 4"	q	1401	1302	1243	1209	1187	1172	1161	1152	1145
		F	1.3+43R	2.9+22R	3.4+14R	3.7+11R	3.9+9R	4+7R	4.1+6R	4.1+5R	4.2+5R
16	VSC2 @ 24"	q	1333	993	787	673	605	560	527	503	484
		F	3+24R	5.2+11R	6.4+7R	7.2+5R	7.7+4R	8.2+3R	8.5+2R	8.8+2R	9+1R
	VSC2 @ 18"	q	1470	1101	883	824	734	670	665	626	594
		F	2.6+24R	4.6+12R	5.7+7R	6+5R	6.6+4R	7.1+3R	7+3R	7.4+2R	7.7+2R
	VSC2 @ 12"	q	1470	1199	1038	948	890	850	820	798	781
		F	2.6+24R	4.1+12R	4.8+8R	5.3+6R	5.5+4R	5.7+4R	5.9+3R	6+3R	6.1+2R
	VSC2 @ 8"	q	1578	1363	1235	1161	1114	1081	1057	1039	1024
		F	2.3+24R	3.6+12R	4.1+8R	4.4+6R	4.5+5R	4.7+4R	4.7+3R	4.8+3R	4.9+3R
	VSC2 @ 6"	q	1663	1494	1392	1334	1296	1270	1250	1235	1224
		F	2.1+25R	3.2+12R	3.6+8R	3.8+6R	4+5R	4.1+4R	4.1+3R	4.2+3R	4.2+3R
	VSC2 @ 4"	q	1786	1678	1615	1578	1555	1538	1526	1517	1509
		F	1.8+25R	2.7+12R	3.1+8R	3.3+6R	3.4+5R	3.4+4R	3.5+3R	3.5+3R	3.6+3R

See footnotes on page 82.

Type HSN3™ -NS

- 32/5 Weld Pattern at Supports
- Sidelaps Connected with #10 Screws

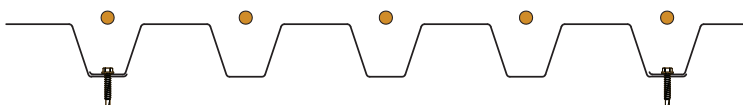

Allowable Diaphragm Shear Strength, q (plf) and Flexibility Factors, F ((in./lb)x10⁶)

DECK GAGE	SIDELAP ATTACHMENT	SPAN (ft.-in.)									
		4'-0"	6'-0"	8'-0"	10'-0"	12'-0"	14'-0"	16'-0"	18'-0"	20'-0"	
22	#10 @ 24"	q	349	264	222	197	181	169	160	153	148
		F	6.6+69R	9.4+45R	11+33R	12.1+26R	12.9+22R	13.4+18R	13.9+16R	14.2+14R	14.5+13R
	#10 @ 18"	q	398	296	271	236	213	211	197	186	187
		F	5.4+69R	8.1+46R	8.9+34R	10+27R	10.9+22R	10.9+19R	11.5+17R	12+15R	11.8+13R
	#10 @ 12"	q	446	361	320	295	278	267	258	251	245
		F	4.5+70R	6.5+46R	7.6+34R	8.2+28R	8.7+23R	9+20R	9.3+17R	9.4+15R	9.6+14R
	#10 @ 8"	q	544	459	418	393	376	364	356	349	343
		F	3.5+70R	5.2+47R	6.1+35R	6.6+28R	7+23R	7.3+20R	7.5+17R	7.6+15R	7.7+14R
	#10 @ 6"	q	622	546	506	481	464	452	443	435	429
		F	2.8+70R	4.4+47R	5.3+35R	5.8+28R	6.1+23R	6.3+20R	6.5+17R	6.7+16R	6.8+14R
	#10 @ 4"	q	746	683	649	628	614	603	595	589	538
		F	2.1+70R	3.6+47R	4.4+35R	4.8+28R	5.2+23R	5.4+20R	5.5+18R	5.7+16R	5.8+14R
20	#10 @ 24"	q	495	367	307	272	248	231	218	208	200
		F	6.9+43R	9+28R	10.3+20R	11.2+16R	11.8+13R	12.3+11R	12.6+10R	12.9+9R	13.2+8R
	#10 @ 18"	q	560	410	372	323	291	286	266	251	252
		F	5.8+43R	7.9+28R	8.4+21R	9.3+17R	10+14R	9.9+12R	10.4+10R	10.8+9R	10.7+8R
	#10 @ 12"	q	624	496	436	400	377	360	347	337	329
		F	5+44R	6.4+29R	7.2+22R	7.6+17R	8+14R	8.2+12R	8.4+11R	8.5+9R	8.6+9R
	#10 @ 8"	q	744	624	565	529	505	488	475	465	457
		F	4+44R	5.2+29R	5.8+22R	6.2+18R	6.4+15R	6.6+12R	6.8+11R	6.9+10R	7+9R
	#10 @ 6"	q	837	732	676	642	618	601	588	578	570
		F	3.4+44R	4.5+30R	5.1+22R	5.4+18R	5.6+15R	5.8+13R	5.9+11R	6+10R	6.1+9R
	#10 @ 4"	q	998	912	865	835	815	801	789	781	708
		F	2.7+45R	3.7+30R	4.2+22R	4.5+18R	4.7+15R	4.9+13R	5+11R	5.1+10R	5.2+9R
18	#10 @ 24"	q	854	619	514	451	408	378	356	338	324
		F	6.6+20R	8.1+13R	9+9R	9.7+7R	10.1+6R	10.5+5R	10.8+4R	11+4R	11.2+3R
	#10 @ 18"	q	953	685	613	530	474	463	430	404	403
		F	5.6+21R	7.1+13R	7.3+10R	8+8R	8.6+6R	8.5+5R	8.9+5R	9.2+4R	9+4R
	#10 @ 12"	q	1049	817	712	648	606	576	553	536	522
		F	4.9+21R	5.8+14R	6.3+10R	6.6+8R	6.8+7R	7+6R	7.1+5R	7.2+4R	7.3+4R
	#10 @ 8"	q	1201	1011	909	846	803	772	749	731	716
		F	4.1+21R	4.8+14R	5.1+11R	5.3+8R	5.5+7R	5.6+6R	5.7+5R	5.7+5R	5.8+4R
	#10 @ 6"	q	1343	1166	1072	1013	972	943	921	904	890
		F	3.6+22R	4.2+14R	4.5+11R	4.6+9R	4.8+7R	4.9+6R	4.9+5R	5+5R	5+4R
	#10 @ 4"	q	1590	1442	1362	1312	1277	1252	1233	1218	1085
		F	3+22R	3.5+14R	3.8+11R	3.9+9R	4+7R	4.1+6R	4.2+5R	4.2+5R	4.2+4R
16	#10 @ 24"	q	1104	801	670	591	539	501	473	451	434
		F	6.1+11R	7.3+7R	8+5R	8.5+4R	8.9+3R	9.2+2R	9.5+2R	9.6+2R	9.8+1R
	#10 @ 18"	q	1242	893	808	702	631	620	577	544	545
		F	5.2+11R	6.4+7R	6.5+5R	7.1+4R	7.5+3R	7.4+3R	7.8+2R	8+2R	7.9+2R
	#10 @ 12"	q	1357	1078	947	868	815	778	750	728	711
		F	4.6+12R	5.2+8R	5.6+6R	5.8+4R	6+4R	6.1+3R	6.2+3R	6.3+2R	6.3+2R
	#10 @ 8"	q	1567	1335	1211	1134	1081	1043	1015	992	974
		F	3.8+12R	4.3+8R	4.5+6R	4.7+5R	4.8+4R	4.9+3R	4.9+3R	5+3R	5+2R
	#10 @ 6"	q	1758	1546	1432	1361	1312	1277	1250	1229	1212
		F	3.3+12R	3.7+8R	3.9+6R	4.1+5R	4.1+4R	4.2+3R	4.2+3R	4.3+3R	4.3+2R
	#10 @ 4"	q	2086	1914	1820	1761	1720	1691	1668	1651	1514
		F	2.8+12R	3.1+8R	3.3+6R	3.4+5R	3.5+4R	3.5+4R	3.6+3R	3.6+3R	3.6+2R

See footnotes on page 82.

Notes:

Legacy
2015 IBC

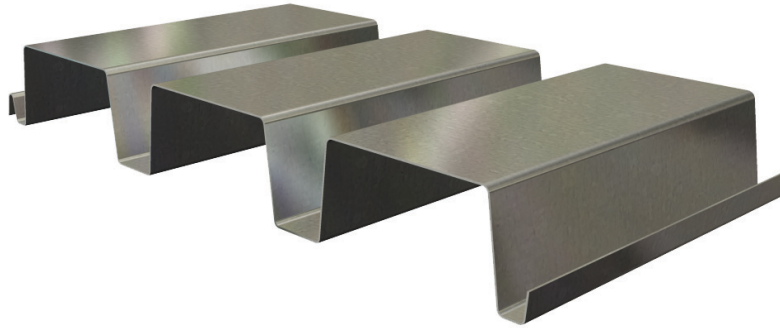

PLN™-24 and N-24

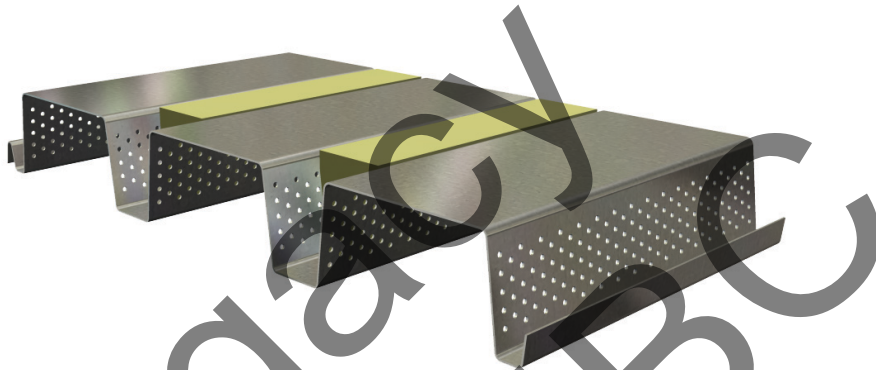

PLN™-24 AC and N-24 AC

PLN™-24 AND N-24 DECK CONTENTS

Section Properties	104
Vertical Load Capacity	107
PLN™-24 Allowable Diaphragm Shear Strength and Flexibility Tables	108-121
PLN-24 with Welds	108
PLN-24 with Hilti fasteners	109-111
PLN-24 with Pneutek fasteners	112-119
PLN-24 with Screws	120-121
N-24 Allowable Diaphragm Shear Strength and Flexibility Tables	122
N-24 with Welds	122
Acoustical Properties	155

Type PLN™ -24 or N-24

- 3" Deep Roof Deck
- Primer Painted or Galvanized
- PLN-24 Deck used with PunchLok II System
- N-24 Deck used with TSWs, BPs or Screws



Dimensions

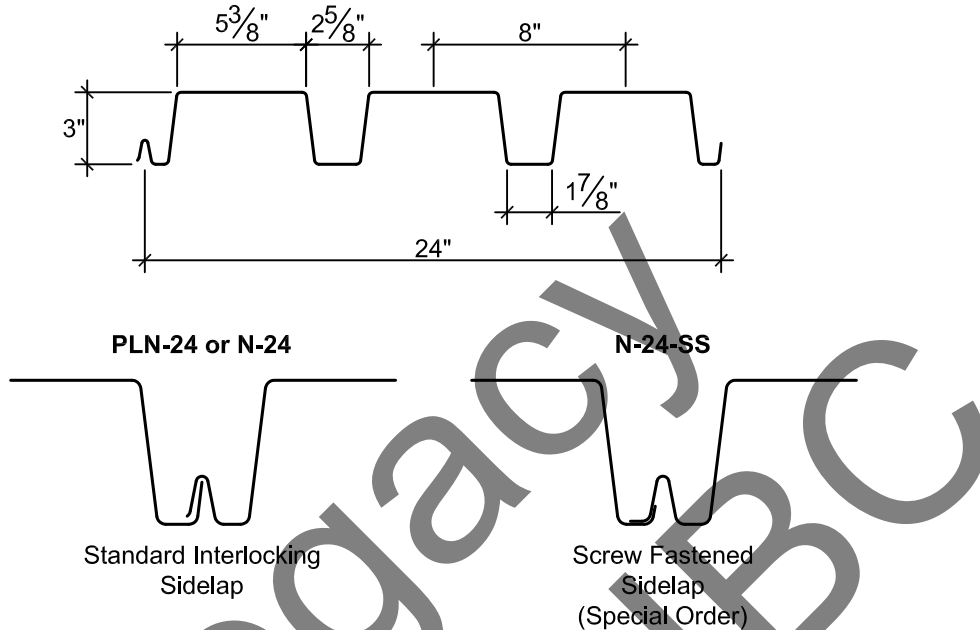

Deck Weight and Section Properties

Gage	Weight		I_d for Deflection		Moment		Allowable Reactions per ft of Width (lb)									
	Galv (psf)	Painted (psf)	Single Span (in. ⁴ /ft)	Multi Span (in. ⁴ /ft)	+ S_{eff} (in. ³ /ft)	- S_{eff} (in. ³ /ft)	One Flange Loading				Two Flange Loading					
							End Bearing Length		Interior Bearing Length		End Bearing Length		Interior Bearing Length			
							2"	3"	4"	4"	8"	2"	3"	4"	4"	8"
22	2.2	2.1	0.733	0.857	0.344	0.429	654	753	836	1300	1518	620	694	757	1530	1804
20	2.6	2.5	0.908	1.032	0.443	0.531	921	1056	1169	1823	2259	931	1038	1128	2182	2742
18	3.5	3.4	1.267	1.369	0.652	0.735	1566	1783	1967	3085	3860	1730	1915	2070	3771	4794
16	4.2	4.1	1.642	1.706	0.837	0.914	2367	2681	2946	4648	5758	2776	3055	3290	5756	7249

- Notes:**
1. Section properties are based on $F_y = 50,000$ psi.
 2. I_d is for deflection due to uniform loads.
 3. S_{eff} (+ or -) is the effective section modulus.
 4. Multiply tabulated deck values listed above by the following adjustment factors to obtain acoustical deck section properties:

Deck Type	I_d for Deflection		Moment		Allowable Reactions per ft of Width (lb) One Flange Loading	
	Single Span	Multi Span	+ S_{eff}	- S_{eff}	End Bearing	Interior Bearing
N-24 - Acoustical	0.94	0.95	0.92	0.94	1.00	0.84

5. Allowable (ASD) reactions are based on web crippling, per AISI S100 Section C3.4, where $\Omega_w = 1.70$ for end bearing and 1.75 for interior bearing. Nominal reactions may be determined by multiplying the table values by Ω_w . LRFD reactions may be determined by multiplying nominal reactions by $\Phi_w = 0.90$ for end reactions and 0.85 for interior reactions.

Type PLN™ -24 or N-24



Attachment Patterns to Supports

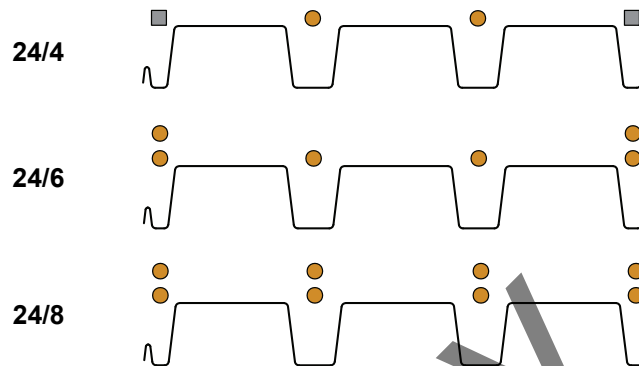

Note: ● indicates location of arc spot weld, power actuated fastener, or screw as indicated in the load tables.
■ indicates location of arc seam weld, power actuated fastener, or screw as indicated in the load tables.

Footnotes for Allowable Uniform Load Tables

1. Stress = Allowable uniform load based on maximum allowable flexural stress in deck.
2. L/360, L/240 or L/180 = Uniform load which produces selected deflection in deck.
3. The symbol ♦♦ indicates allowable uniform load based on deflection exceeds allowable uniform load based on stress.
4. Nominal uniform loads governed by stress may be determined by multiplying the allowable values in the table by $\Omega_b = 1.67$. LRFD loads may be determined by multiplying nominal loads by $\Phi_b = 0.95$.

LESLIE BROS
2015

Type PLN™ -24 or N-24



Footnotes for Diaphragm Shear Strength and Flexibility Factor Tables

General Notes

- VSC2 = Verco Sidelap Connection 2; BP = Button Punch; TSW = Top Seam Weld.
- The dimension from the first and last sidelap connection within each span is to be no more than one-half of specified spacing.
- R is the ratio of vertical span (L_V) of the deck to the length (L_S) of the deck sheet: $R = L_V / L_S$.
- Interpolation of diaphragm shear strength between adjacent spans or sidelap spacings is permissible. For interpolation of the diaphragm flexibility factor between adjacent spans, use the flexibility factor for the closest adjacent span length.
- Diaphragm shear values for side seam fasteners placed at spacings other than those in the table should be determined based on the number of fasteners in each span.
- For acoustical deck profiles, modify tabulated q and F values using the following adjustment factors:

Deck Type	R_q	R_F
N-24 - Acoustical	0.94	1.05

Note: Adjustment Factor, R_q must be applied only to allowable diaphragm shear strengths governed by panel buckling which are shown in the shaded areas of the diaphragm tables.

- N-24-SS and N-24-SS AC are available upon special order. To calculate diaphragm shear strength and flexibility factors for these profiles, refer to the design equations listed at the end of Verco's Evaluation Report No. 0217.

Notes Specific to Tables using Welds to Supports

- The allowable diaphragm shear values in the table utilize a factor of safety, $\Omega = 3.0$ (limited by connections) with the exception of the gray shaded table values, which utilize a factor of safety of $\Omega = 2.0$ (limited by panel buckling).
- A 1" x 3/8" effective arc seam weld is required at supports adjacent to sidelap and a 1/2" effective diameter arc spot welds are required at supports in interior flutes.

Notes Specific to Tables using Hilti or Pneutek Fasteners to Supports

- X-EDNK22 = Hilti EDNK22 THQ12 fastener; X-ENP-19 = Hilti X-ENP-19 L15 fastener; K66 = Pneutek K66062 or K66075 fasteners; K64 = Pneutek K64062 fastener; SDK63 = Pneutek SDK63075; SDK61 = Pneutek SDK61075
- The allowable diaphragm shear values in the table utilize a factor of safety, $\Omega = 2.5$ (limited by connections) with the exception of the shaded table values, which utilize a factor of safety of $\Omega = 2.0$ (limited by panel buckling).

Notes Specific to Tables using Screws to Supports

- The allowable diaphragm shear values in the table utilize a factor of safety, $\Omega = 2.5$ (limited by connections) with the exception of the shaded table values, which utilize a factor of safety of $\Omega = 2.0$ (limited by panel buckling).
- Deck is attached with minimum #12 Screws (self drilling, self tapping) to supports. Select appropriate screw based on actual substrate thickness. This table is provided as a guide, proper selection should be verified based on the specific fasteners used.

Support Thickness	Fastener Designation
33 mil (0.0346") to 3/16"	#3 Drill Point
1/8" to 1/4"	#4 Drill Point
1/8" to 1/2"	#5 Drill Point

- All tabulated diaphragm values shown in this section are for a minimum 0.0385 in. thick support with SDI recognized screws produced by Buildex, Elco, Hilti or Simpson Strong-Tie. If the minimum support thickness can not be met or a screw that is not recognized by SDI is used, modify tabulated q and F values based on actual substrate and thickness using Adjustment Factors listed in this table.

Substrate Thickness and Strength

Deck Gage	Factors	Substrate Thickness and Strength									
		20 ga		18 ga		16 ga		14 ga		≥ 12 ga	
		33 mil (0.0345 in)	50 ksi	43 mil (0.0451 in)	50 ksi	54 mil (0.0566 in)	50 ksi	68 mil (0.0713 in)	50 ksi	≥ 97 mil (0.1017 in)	50 ksi
22	R_q	0.44	0.61	0.67	0.78	0.78	0.78	0.78	0.78	0.78	0.78
	R_F	1.28	1.25	1.17	1.00	1.00	1.00	1.00	1.00	1.00	1.00
20	R_q	0.34	0.49	0.54	0.74	0.74	0.78	0.78	0.78	0.78	0.78
	R_F	1.31	1.31	1.24	1.19	1.15	1.00	1.00	1.00	1.00	1.00
18	R_q	0.26	0.37	0.38	0.55	0.55	0.78	0.76	0.78	0.78	0.78
	R_F	1.34	1.39	1.30	1.31	1.26	1.18	1.19	1.00	1.00	1.00
16	R_q	0.20	0.30	0.30	0.44	0.43	0.65	0.61	0.78	0.78	0.78
	R_F	1.43	1.66	1.39	1.54	1.33	1.34	1.25	1.00	1.00	1.00

- Adjustment factors are based on connection strengths determined in accordance with Section E4 of AISI S100. These self drilling, self tapping screws must be compliant with ASTM C1315.
- Allowable Diaphragm Strength = $q \cdot R_q$; Flexibility Factor = $F \cdot R_F$.
- These adjustment factors are based on the maximum adjustment for the tabulated span lengths and fastener patterns. To calculate a specific condition, use design equations listed at the end of Evaluation Report ER-0217.

Type PLN™ -24 or N-24



Allowable Uniform Loads (psf)

DECK			SPAN (ft.-in.)																
SPAN	GAGE	CRITERIA	4'-0"	5'-0"	6'-0"	7'-0"	8'-0"	9'-0"	10'-0"	11'-0"	12'-0"	13'-0"	14'-0"	15'-0"	16'-0"	17'-0"	18'-0"	19'-0"	20'-0"
SINGLE	22	Stress	300	275	191	140	108	85	69	57	48	41	35	31	27	24	21	19	17
		L/360	◆◆◆	257	149	94	63	44	32	24	19	15	12	10	8	7	6	5	4
		L/240	◆◆◆	◆◆◆	◆◆◆	140	94	66	48	36	28	22	18	14	12	10	8	7	6
	20	Stress	300	300	246	181	138	109	89	73	62	52	45	39	35	31	27	25	22
		L/360	◆◆◆	◆◆◆	184	116	78	55	40	30	23	18	14	12	10	8	7	6	5
		L/240	◆◆◆	◆◆◆	◆◆◆	174	116	82	60	45	35	27	22	18	15	12	10	9	7
	18	Stress	300	300	300	266	204	161	130	108	91	77	67	58	51	45	40	36	33
		L/360	◆◆◆	◆◆◆	257	162	108	76	55	42	32	25	20	16	14	11	10	8	7
		L/240	◆◆◆	◆◆◆	◆◆◆	243	162	114	83	63	48	38	30	25	20	17	14	12	10
	16	Stress	300	300	300	300	262	207	167	136	116	99	85	74	65	58	52	46	42
		L/360	◆◆◆	◆◆◆	◆◆◆	210	140	99	72	54	42	33	26	21	18	15	12	10	9
		L/240	◆◆◆	◆◆◆	◆◆◆	◆◆◆	211	148	108	81	62	49	39	32	26	22	18	16	13
DOUBLE	22	Stress	300	300	238	175	134	106	86	71	60	51	44	38	34	30	26	24	21
		L/360	◆◆◆	◆◆◆	◆◆◆	◆◆◆	◆◆◆	◆◆◆	◆◆◆	◆◆◆	◆◆◆	◆◆◆	◆◆◆	◆◆◆	◆◆◆	◆◆◆	◆◆◆	◆◆◆	◆◆◆
		L/240	◆◆◆	◆◆◆	◆◆◆	◆◆◆	◆◆◆	◆◆◆	◆◆◆	◆◆◆	◆◆◆	◆◆◆	◆◆◆	◆◆◆	◆◆◆	◆◆◆	◆◆◆	◆◆◆	◆◆◆
	20	Stress	300	300	295	217	166	131	106	88	74	63	54	47	41	37	33	29	27
		L/360	◆◆◆	◆◆◆	◆◆◆	◆◆◆	◆◆◆	◆◆◆	◆◆◆	◆◆◆	◆◆◆	◆◆◆	◆◆◆	◆◆◆	◆◆◆	◆◆◆	◆◆◆	◆◆◆	◆◆◆
		L/240	◆◆◆	◆◆◆	◆◆◆	◆◆◆	◆◆◆	◆◆◆	◆◆◆	◆◆◆	◆◆◆	◆◆◆	◆◆◆	◆◆◆	◆◆◆	◆◆◆	◆◆◆	◆◆◆	◆◆◆
	18	Stress	300	300	300	300	230	181	147	121	102	87	75	65	57	51	45	41	37
		L/360	◆◆◆	◆◆◆	◆◆◆	◆◆◆	◆◆◆	◆◆◆	◆◆◆	◆◆◆	◆◆◆	◆◆◆	◆◆◆	◆◆◆	◆◆◆	◆◆◆	◆◆◆	◆◆◆	◆◆◆
		L/240	◆◆◆	◆◆◆	◆◆◆	◆◆◆	◆◆◆	◆◆◆	◆◆◆	◆◆◆	◆◆◆	◆◆◆	◆◆◆	◆◆◆	◆◆◆	◆◆◆	◆◆◆	◆◆◆	◆◆◆
	16	Stress	300	300	300	300	286	226	183	151	127	108	93	81	71	63	56	51	46
		L/360	◆◆◆	◆◆◆	◆◆◆	◆◆◆	◆◆◆	◆◆◆	◆◆◆	◆◆◆	◆◆◆	◆◆◆	◆◆◆	◆◆◆	◆◆◆	◆◆◆	◆◆◆	◆◆◆	◆◆◆
		L/240	◆◆◆	◆◆◆	◆◆◆	◆◆◆	◆◆◆	◆◆◆	◆◆◆	◆◆◆	◆◆◆	◆◆◆	◆◆◆	◆◆◆	◆◆◆	◆◆◆	◆◆◆	◆◆◆	◆◆◆
TRIPLE	22	Stress	300	300	298	219	168	132	107	89	74	63	55	48	42	37	33	30	27
		L/360	◆◆◆	◆◆◆	◆◆◆	206	138	97	71	53	41	32	26	21	17	14	12	10	9
		L/240	◆◆◆	◆◆◆	◆◆◆	◆◆◆	◆◆◆	◆◆◆	◆◆◆	◆◆◆	◆◆◆	◆◆◆	◆◆◆	◆◆◆	◆◆◆	◆◆◆	◆◆◆	◆◆◆	◆◆◆
	20	Stress	300	300	300	271	207	164	133	110	92	79	68	59	52	46	41	37	33
		L/360	◆◆◆	◆◆◆	◆◆◆	248	166	117	85	64	49	39	31	25	21	17	15	12	11
		L/240	◆◆◆	◆◆◆	◆◆◆	◆◆◆	◆◆◆	◆◆◆	◆◆◆	◆◆◆	◆◆◆	◆◆◆	◆◆◆	◆◆◆	◆◆◆	◆◆◆	◆◆◆	◆◆◆	◆◆◆
	18	Stress	300	300	300	300	287	227	184	152	128	109	94	82	72	64	57	51	46
		L/360	◆◆◆	◆◆◆	◆◆◆	◆◆◆	221	155	113	85	65	51	41	33	28	23	19	16	14
		L/240	◆◆◆	◆◆◆	◆◆◆	◆◆◆	◆◆◆	◆◆◆	◆◆◆	◆◆◆	◆◆◆	◆◆◆	◆◆◆	◆◆◆	◆◆◆	◆◆◆	◆◆◆	◆◆◆	◆◆◆
	16	Stress	300	300	300	300	300	282	229	189	159	135	117	102	89	79	71	63	57
		L/360	◆◆◆	◆◆◆	◆◆◆	◆◆◆	275	193	141	106	81	64	51	42	34	29	24	21	18
		L/240	◆◆◆	◆◆◆	◆◆◆	◆◆◆	◆◆◆	◆◆◆	◆◆◆	◆◆◆	◆◆◆	◆◆◆	◆◆◆	◆◆◆	◆◆◆	◆◆◆	◆◆◆	◆◆◆	◆◆◆

See footnotes on page 105.

Type PLN™ -24

- 24/4 Weld Pattern at Supports
- Sidelaps Connected with PunchLok II Tool

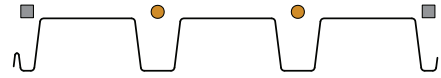

Allowable Diaphragm Shear Strength, q (plf) and Flexibility Factors, F ((in./lb)x10⁶)

DECK GAGE	SIDELAP ATTACHMENT	SPAN (ft.-in.)									
		4'-0"	6'-0"	8'-0"	10'-0"	12'-0"	14'-0"	16'-0"	18'-0"	20'-0"	
22	VSC2 @ 24"	q	559	488	453	433	419	409	402	396	391
		F	4.3+191R	11.2+125R	15.2+93R	17.9+73R	19.9+61R	21.4+51R	22.5+45R	23.5+39R	24.3+35R
	VSC2 @ 18"	q	734	604	626	573	535	554	529	509	525
		F	2.4+192R	9.1+126R	11.5+95R	14.3+75R	16.4+62R	16.7+53R	18.1+46R	19.2+41R	19.1+37R
	VSC2 @ 12"	q	873	805	771	749	735	724	717	690	559
		F	1.1+193R	6.4+128R	9.2+95R	11+76R	12.2+63R	13.1+54R	13.8+47R	14.3+42R	14.8+38R
	VSC2 @ 8"	q	1103	1049	1021	1003	991	983	873	690	559
		F	-0.8+193R	4+129R	6.5+96R	8+77R	9+64R	9.7+55R	10.2+48R	10.7+43R	11+38R
	VSC2 @ 6"	q	1285	1242	1220	1207	1197	1140	873	690	559
		F	-1.9+194R	2.6+129R	4.9+97R	6.2+77R	7.2+64R	7.8+55R	8.3+48R	8.7+43R	9+39R
	VSC2 @ 4"	q	1534	1509	1496	1488	1482	1140	873	690	559
		F	-3.3+194R	1+129R	3.1+97R	4.4+78R	5.2+65R	5.8+55R	6.3+48R	6.7+43R	7+39R
20	VSC2 @ 24"	q	796	687	637	607	587	573	562	554	547
		F	5.8+120R	10.4+79R	13.1+58R	14.8+46R	16.1+38R	17+32R	17.8+28R	18.4+25R	18.9+22R
	VSC2 @ 18"	q	1016	849	865	792	742	767	732	705	726
		F	4.1+121R	8.6+80R	10+60R	11.8+47R	13.2+39R	13.3+34R	14.2+29R	15+26R	14.8+23R
	VSC2 @ 12"	q	1195	1106	1059	1031	1011	997	987	906	734
		F	2.9+122R	6.3+81R	8.1+60R	9.2+48R	10+40R	10.5+34R	10.9+30R	11.3+27R	11.5+24R
	VSC2 @ 8"	q	1496	1426	1390	1367	1352	1341	1146	906	734
		F	1.3+122R	4.4+81R	5.9+61R	6.8+49R	7.5+41R	7.9+35R	8.3+30R	8.5+27R	8.7+24R
	VSC2 @ 6"	q	1727	1674	1646	1628	1617	1497	1146	906	734
		F	0.4+123R	3.2+82R	4.7+61R	5.5+49R	6.1+41R	6.5+35R	6.8+31R	7.1+27R	7.3+24R
	VSC2 @ 4"	q	2033	2002	1986	1977	1970	1497	1146	906	734
		F	-0.7+123R	2+82R	3.3+61R	4.1+49R	4.7+41R	5.1+35R	5.4+31R	5.6+27R	5.8+25R
18	VSC2 @ 24"	q	1312	1116	1027	973	938	912	893	877	864
		F	5.4+59R	7.6+39R	8.8+29R	9.6+23R	10.1+19R	10.5+16R	10.8+14R	11+12R	11.2+11R
	VSC2 @ 18"	q	1613	1347	1364	1247	1168	1204	1149	1106	1124
		F	4+59R	6.3+39R	6.7+29R	7.6+23R	8.3+19R	8.2+17R	8.7+14R	9+13R	8.9+12R
	VSC2 @ 12"	q	1882	1736	1659	1612	1580	1557	1540	1387	1124
		F	3.2+60R	4.7+40R	5.5+30R	6+24R	6.4+20R	6.6+17R	6.8+15R	6.9+13R	7+12R
	VSC2 @ 8"	q	2327	2215	2156	2119	2094	2076	1756	1387	1124
		F	2.1+60R	3.5+40R	4.2+30R	4.7+24R	5+20R	5.2+17R	5.3+15R	5.4+13R	5.5+12R
	VSC2 @ 6"	q	2664	2580	2535	2507	2488	2294	1756	1387	1124
		F	1.5+60R	2.9+40R	3.5+30R	3.9+24R	4.2+20R	4.4+17R	4.6+15R	4.7+13R	4.8+12R
	VSC2 @ 4"	q	3102	3055	3030	3015	3004	2294	1756	1387	1124
		F	0.9+60R	2.2+40R	2.8+30R	3.2+24R	3.4+20R	3.6+17R	3.8+15R	3.9+13R	4+12R
16	VSC2 @ 24"	q	1711	1477	1367	1300	1255	1221	1195	1175	1159
		F	5.6+33R	7+22R	7.8+16R	8.4+13R	8.7+11R	9+9R	9.2+8R	9.4+7R	9.5+6R
	VSC2 @ 18"	q	2113	1777	1809	1660	1557	1609	1538	1482	1526
		F	4.3+34R	5.9+22R	6.1+17R	6.7+13R	7.2+11R	7.1+9R	7.4+8R	7.7+7R	7.6+7R
	VSC2 @ 12"	q	2468	2292	2200	2143	2105	2077	2056	1936	1568
		F	3.6+34R	4.5+22R	5+17R	5.4+13R	5.6+11R	5.7+10R	5.8+8R	5.9+7R	6+7R
	VSC2 @ 8"	q	3043	2912	2843	2800	2771	2750	2450	1936	1568
		F	2.7+34R	3.5+23R	3.9+17R	4.2+14R	4.4+11R	4.5+10R	4.6+8R	4.7+8R	4.7+7R
	VSC2 @ 6"	q	3466	3371	3320	3288	3267	3200	2450	1936	1568
		F	2.2+34R	2.9+23R	3.3+17R	3.6+14R	3.7+11R	3.9+10R	3.9+9R	4+8R	4.1+7R
	VSC2 @ 4"	q	4000	3948	3921	3904	3893	3200	2450	1936	1568
		F	1.6+34R	2.4+23R	2.7+17R	2.9+14R	3.1+11R	3.2+10R	3.3+9R	3.3+8R	3.4+7R

See footnotes on page 106.

Type PLN™ -24

- 24/4 Hilti Fastener Pattern at Supports
X-EDNK22 at Supports 1/8" to 1/4" thick
X-HSN24 at Supports 1/8" to 3/8" thick
- Sidelaps Connected with PunchLok II Tool



Allowable Diaphragm Shear Strength, q (plf) and Flexibility Factors, F ((in./lb)x10⁶)

DECK GAGE	SIDELAP ATTACHMENT	SPAN (ft-in.)									
		4'-0"	6'-0"	8'-0"	10'-0"	12'-0"	14'-0"	16'-0"	18'-0"	20'-0"	
22	VSC2 @ 24"	q	556	506	480	464	453	445	439	435	431
		F	4.9+191R	11.8+125R	15.8+93R	18.4+73R	20.4+61R	21.8+52R	23+45R	23.9+40R	24.7+35R
	VSC2 @ 18"	q	688	604	627	586	558	578	558	541	558
		F	2.8+192R	9.5+126R	11.9+95R	14.7+75R	16.7+62R	17+53R	18.4+46R	19.5+41R	19.4+37R
	VSC2 @ 12"	q	791	760	743	733	726	721	717	690	559
		F	1.4+193R	6.6+128R	9.5+95R	11.2+76R	12.4+63R	13.3+54R	13.9+47R	14.5+42R	14.9+38R
	VSC2 @ 8"	q	932	913	903	897	893	890	873	690	559
		F	-0.6+193R	4.1+129R	6.6+96R	8.1+77R	9.1+64R	9.8+55R	10.3+48R	10.7+43R	11.1+38R
	VSC2 @ 6"	q	1016	1005	999	996	993	991	873	690	559
		F	-1.8+194R	2.7+129R	4.9+97R	6.3+77R	7.2+64R	7.9+55R	8.4+48R	8.8+43R	9.1+39R
	VSC2 @ 4"	q	1103	1099	1096	1095	1094	1093	873	690	559
		F	-3.2+194R	1+129R	3.1+97R	4.4+78R	5.3+65R	5.9+55R	6.3+48R	6.7+43R	7+39R
20	VSC2 @ 24"	q	720	665	635	617	605	596	590	585	580
		F	6.3+120R	10.8+79R	13.4+59R	15.2+46R	16.4+38R	17.3+33R	18.1+28R	18.6+25R	19.1+22R
	VSC2 @ 18"	q	886	790	822	774	740	767	742	722	734
		F	4.4+121R	8.9+80R	10.2+60R	12.1+47R	13.5+39R	13.5+34R	14.4+29R	15.2+26R	15+23R
	VSC2 @ 12"	q	1010	979	962	952	945	940	936	906	734
		F	3.1+122R	6.5+81R	8.2+60R	9.3+48R	10.1+40R	10.6+34R	11+30R	11.3+27R	11.6+24R
	VSC2 @ 8"	q	1169	1152	1143	1137	1133	1130	1128	906	734
		F	1.5+122R	4.4+81R	6+61R	6.9+49R	7.5+41R	8+35R	8.3+30R	8.6+27R	8.8+24R
	VSC2 @ 6"	q	1258	1248	1243	1240	1238	1236	1146	906	734
		F	0.5+123R	3.3+82R	4.7+61R	5.6+49R	6.1+41R	6.6+35R	6.9+31R	7.1+27R	7.3+24R
	VSC2 @ 4"	q	1344	1340	1338	1337	1336	1336	1146	906	734
		F	-0.7+123R	2+82R	3.3+61R	4.2+49R	4.7+41R	5.1+35R	5.4+31R	5.6+27R	5.8+25R
18	VSC2 @ 24"	q	1035	969	934	913	898	887	879	873	868
		F	5.6+59R	7.8+39R	9+29R	9.7+23R	10.2+19R	10.6+16R	10.9+14R	11.1+13R	11.3+11R
	VSC2 @ 18"	q	1262	1142	1190	1129	1085	1123	1091	1065	1095
		F	4.2+59R	6.4+39R	6.8+29R	7.7+23R	8.4+19R	8.3+17R	8.7+15R	9.1+13R	8.9+12R
	VSC2 @ 12"	q	1420	1388	1370	1360	1352	1347	1343	1340	1124
		F	3.2+60R	4.8+40R	5.6+30R	6.1+24R	6.4+20R	6.6+17R	6.8+15R	7+13R	7.1+12R
	VSC2 @ 8"	q	1610	1594	1585	1580	1576	1573	1571	1387	1124
		F	2.2+60R	3.6+40R	4.3+30R	4.7+24R	5+20R	5.2+17R	5.3+15R	5.4+13R	5.5+12R
	VSC2 @ 6"	q	1709	1700	1696	1693	1691	1689	1688	1387	1124
		F	1.5+60R	2.9+40R	3.6+30R	4+24R	4.2+20R	4.4+17R	4.6+15R	4.7+13R	4.8+12R
	VSC2 @ 4"	q	1800	1796	1795	1794	1793	1792	1756	1387	1124
		F	0.9+60R	2.2+40R	2.8+30R	3.2+24R	3.4+20R	3.6+17R	3.8+15R	3.9+13R	4+12R
16	VSC2 @ 24"	q	1344	1268	1228	1203	1186	1173	1164	1157	1151
		F	5.7+33R	7.2+22R	8+16R	8.5+13R	8.8+11R	9.1+9R	9.3+8R	9.5+7R	9.6+6R
	VSC2 @ 18"	q	1627	1485	1547	1474	1421	1469	1430	1398	1436
		F	4.4+34R	6+22R	6.1+17R	6.8+13R	7.3+11R	7.1+9R	7.5+8R	7.7+7R	7.6+7R
	VSC2 @ 12"	q	1817	1782	1763	1752	1744	1738	1734	1730	1568
		F	3.6+34R	4.6+23R	5.1+17R	5.4+13R	5.6+11R	5.7+10R	5.8+8R	5.9+7R	6+7R
	VSC2 @ 8"	q	2035	2018	2009	2004	2000	1997	1995	1936	1568
		F	2.7+34R	3.5+23R	4+17R	4.2+14R	4.4+11R	4.5+10R	4.6+9R	4.7+8R	4.7+7R
	VSC2 @ 6"	q	2144	2135	2131	2128	2126	2125	2124	1936	1568
		F	2.2+34R	3+23R	3.4+17R	3.6+14R	3.8+11R	3.9+10R	3.9+9R	4+8R	4.1+7R
	VSC2 @ 4"	q	2242	2238	2237	2236	2235	2235	2234	1936	1568
		F	1.6+34R	2.4+23R	2.7+17R	3+14R	3.1+11R	3.2+10R	3.3+9R	3.3+8R	3.4+7R

See footnotes on page 106.

Type PLN™ -24

- 24/6 Hilti Fastener Pattern at Supports
X-EDNK22 at Supports 1/8" to 1/4" thick
X-HSN24 at Supports 1/8" to 3/8" thick
- Sidelaps Connected with PunchLok II Tool

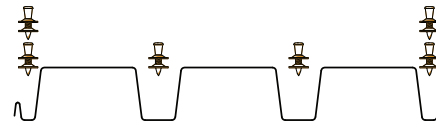

Allowable Diaphragm Shear Strength, q (plf) and Flexibility Factors, F ((in./lb)x10⁶)

DECK GAGE	SIDELAP ATTACHMENT	SPAN (ft.-in.)									
		4'-0"	6'-0"	8'-0"	10'-0"	12'-0"	14'-0"	16'-0"	18'-0"	20'-0"	
22	VSC2 @ 24"	q	740	637	583	549	527	510	498	488	480
		F	1.3+192R	7.9+126R	11.8+93R	14.6+73R	16.7+60R	18.4+51R	19.7+44R	20.8+39R	21.7+35R
	VSC2 @ 18"	q	890	748	751	688	645	662	633	609	559
		F	0.2+192R	6.6+127R	9.5+94R	12.2+75R	14.2+62R	14.9+53R	16.3+46R	17.4+40R	17.6+36R
	VSC2 @ 12"	q	1018	940	899	873	855	842	832	690	559
		F	-0.6+193R	4.8+128R	7.8+95R	9.7+76R	11+63R	12+54R	12.8+47R	13.4+42R	13.9+37R
	VSC2 @ 8"	q	*1220	*1164	*1134	*1115	*1102	1093	873	690	559
		F	-1.8+193R	3.1+128R	5.7+96R	7.3+77R	8.4+64R	9.1+55R	9.8+48R	10.2+42R	10.6+38R
	VSC2 @ 6"	q	*1363	*1324	*1302	*1289	*1280	1140	873	690	559
		F	-2.6+194R	2+129R	4.4+96R	5.8+77R	6.8+64R	7.5+55R	8+48R	8.5+43R	8.8+38R
VSC2 @ 4"	q	*1537	*1517	*1506	*1499	*1494	1140	873	690	559	
	F	-3.7+194R	0.6+129R	2.8+97R	4.2+77R	5.1+65R	5.7+55R	6.2+48R	6.5+43R	6.8+39R	
20	VSC2 @ 24"	q	946	828	765	727	700	682	667	656	647
		F	3.5+121R	8+79R	10.8+59R	12.6+46R	14+38R	15.1+32R	16+28R	16.7+24R	17.2+22R
	VSC2 @ 18"	q	1141	974	988	912	858	884	847	818	734
		F	2.5+121R	6.9+80R	8.6+60R	10.5+47R	11.9+39R	12.2+33R	13.1+29R	13.9+25R	13.9+23R
	VSC2 @ 12"	q	1304	1221	1177	1149	1129	1116	1105	906	734
		F	1.7+122R	5.3+81R	7.2+60R	8.4+48R	9.2+40R	9.9+34R	10.3+30R	10.7+26R	11+24R
	VSC2 @ 8"	q	*1549	*1493	*1463	*1444	*1431	*1421	1146	906	734
		F	0.7+122R	3.8+81R	5.4+61R	6.4+49R	7.1+40R	7.6+35R	8+30R	8.3+27R	8.5+24R
	VSC2 @ 6"	q	*1712	*1674	*1654	*1641	*1633	*1497	1146	906	734
		F	-0.1+123R	2.9+82R	4.4+61R	5.3+49R	5.9+41R	6.3+35R	6.7+30R	6.9+27R	7.1+24R
VSC2 @ 4"	q	*1898	*1880	*1871	*1865	*1861	*1497	1146	906	734	
	F	-0.9+123R	1.8+82R	3.2+61R	4+49R	4.6+41R	5+35R	5.3+31R	5.5+27R	5.7+25R	
18	VSC2 @ 24"	q	1345	1198	1120	1072	1039	1015	998	983	972
		F	4.3+59R	6.5+39R	7.8+29R	8.7+23R	9.3+19R	9.8+16R	10.1+14R	10.4+12R	10.7+11R
	VSC2 @ 18"	q	1626	1411	1443	1342	1270	1311	1261	1221	1124
		F	3.3+59R	5.5+39R	6.2+29R	7.1+23R	7.8+19R	7.8+16R	8.3+14R	8.7+13R	8.6+11R
	VSC2 @ 12"	q	*1850	1756	1704	1672	1651	1635	1623	1387	1124
		F	2.7+59R	4.3+39R	5.2+29R	5.7+24R	6.1+20R	6.4+17R	6.6+15R	6.7+13R	6.9+12R
	VSC2 @ 8"	q	*2166	*2108	*2076	*2056	*2043	*2033	1756	1387	1124
		F	1.9+60R	3.3+40R	4.1+30R	4.5+24R	4.8+20R	5.1+17R	5.2+15R	5.4+13R	5.5+12R
	VSC2 @ 6"	q	*2363	*2327	*2307	*2294	*2286	*2280	1756	1387	1124
		F	1.4+60R	2.7+40R	3.4+30R	3.9+24R	4.1+20R	4.3+17R	4.5+15R	4.6+13R	4.7+12R
VSC2 @ 4"	q	*2574	*2557	*2549	*2543	*2540	*2294	1756	1387	1124	
	F	0.8+60R	2.1+40R	2.8+30R	3.1+24R	3.4+20R	3.6+17R	3.7+15R	3.9+13R	3.9+12R	
16	VSC2 @ 24"	q	1738	1564	1472	1414	1375	1347	1325	1309	1295
		F	4.6+33R	6.1+22R	7+16R	7.7+13R	8.1+10R	8.4+9R	8.7+8R	8.9+7R	9.1+6R
	VSC2 @ 18"	q	2100	1840	1889	1765	1677	1731	1669	1618	1568
		F	3.7+34R	5.3+22R	5.6+16R	6.3+13R	6.8+11R	6.8+9R	7.1+8R	7.4+7R	7.3+6R
	VSC2 @ 12"	q	2381	2275	2218	2182	2158	2140	2126	1936	1568
		F	3.2+34R	4.2+22R	4.8+17R	5.1+13R	5.4+11R	5.5+9R	5.7+8R	5.8+7R	5.9+7R
	VSC2 @ 8"	q	*2763	*2701	*2667	*2646	*2631	*2621	*2450	1936	1568
		F	2.5+34R	3.3+23R	3.8+17R	4.1+14R	4.3+11R	4.4+10R	4.5+8R	4.6+7R	4.7+7R
	VSC2 @ 6"	q	*2991	*2954	*2933	*2920	*2912	*2905	*2450	1936	1568
		F	2+34R	2.8+23R	3.3+17R	3.5+14R	3.7+11R	3.8+10R	3.9+9R	4+8R	4+7R
VSC2 @ 4"	q	*3226	*3210	*3202	*3196	*3193	*3190	*2450	1936	1568	
	F	1.5+34R	2.3+23R	2.7+17R	2.9+14R	3.1+11R	3.2+10R	3.3+9R	3.3+8R	3.4+7R	

1. For diaphragm shear strengths in bold and marked with *, the fastening pattern shall be increased at the building perimeter, chords, collectors to other shear transfer elements to two fasteners per rib (i.e. 24/8 pattern) or shall be limited to 1100 plf, 1400 plf, 1800 plf or 2300 plf for 22, 20, 18 or 16 gage steel deck, respectively. Bearing at supports shall allow for proper end distance and fastener spacing.
2. See footnotes on page 106.

Type PLN™ -24

- 24/4 Hilti Fastener Pattern at Supports
X-ENP19 at Supports 1/4" and thicker
- Sidelaps Connected with PunchLok II Tool



Allowable Diaphragm Shear Strength, q (plf) and Flexibility Factors, F ((in./lb)x10⁶)

DECK GAGE	SIDELAP ATTACHMENT	SPAN (ft-in.)									
		4'-0"	6'-0"	8'-0"	10'-0"	12'-0"	14'-0"	16'-0"	18'-0"	20'-0"	
22	VSC2 @ 24"	q	576	521	492	474	462	453	447	441	437
		F	1.6+192R	8.2+126R	12.2+93R	14.9+73R	17+60R	18.7+51R	20+44R	21+39R	22+35R
	VSC2 @ 18"	q	713	622	644	600	570	591	569	552	559
		F	0.4+192R	6.9+127R	9.7+94R	12.4+75R	14.5+62R	15.1+53R	16.5+46R	17.6+40R	17.7+36R
	VSC2 @ 12"	q	823	787	767	756	748	742	737	690	559
		F	-0.4+193R	5+128R	7.9+95R	9.8+76R	11.2+63R	12.1+54R	12.9+47R	13.5+42R	14+37R
	VSC2 @ 8"	q	977	955	943	936	931	927	873	690	559
		F	-1.7+193R	3.2+128R	5.8+96R	7.3+77R	8.4+64R	9.2+55R	9.8+48R	10.3+42R	10.7+38R
	VSC2 @ 6"	q	1073	1059	1052	1047	1044	1042	873	690	559
		F	-2.6+194R	2+129R	4.4+96R	5.9+77R	6.8+64R	7.5+55R	8.1+48R	8.5+43R	8.8+38R
	VSC2 @ 4"	q	1174	1168	1165	1163	1162	1140	873	690	559
		F	-3.7+194R	0.7+129R	2.9+97R	4.2+77R	5.1+65R	5.7+55R	6.2+48R	6.6+43R	6.9+39R
20	VSC2 @ 24"	q	746	684	651	631	618	608	600	595	590
		F	3.8+121R	8.3+79R	11+58R	12.8+46R	14.2+38R	15.3+32R	16.1+28R	16.8+24R	17.4+22R
	VSC2 @ 18"	q	920	814	846	794	758	786	759	738	734
		F	2.7+121R	7+80R	8.7+60R	10.6+47R	12+39R	12.3+33R	13.2+29R	14+25R	14+23R
	VSC2 @ 12"	q	1053	1017	997	985	977	971	966	906	734
		F	1.8+122R	5.4+81R	7.3+60R	8.5+48R	9.3+40R	9.9+34R	10.4+30R	10.8+26R	11.1+24R
	VSC2 @ 8"	q	1230	1209	1198	1191	1186	1183	1146	906	734
		F	0.7+122R	3.8+81R	5.5+61R	6.5+49R	7.1+40R	7.6+35R	8+30R	8.3+27R	8.5+24R
	VSC2 @ 6"	q	1332	1320	1314	1309	1307	1305	1146	906	734
		F	0+123R	2.9+82R	4.4+61R	5.3+49R	5.9+41R	6.4+35R	6.7+30R	6.9+27R	7.2+24R
	VSC2 @ 4"	q	1434	1429	1427	1425	1424	1423	1146	906	734
		F	-0.9+123R	1.8+82R	3.2+61R	4+49R	4.6+41R	5+35R	5.3+31R	5.5+27R	5.7+25R
18	VSC2 @ 24"	q	1073	998	959	935	918	906	897	890	885
		F	4.4+59R	6.6+39R	7.9+29R	8.8+23R	9.4+19R	9.8+16R	10.2+14R	10.5+12R	10.7+11R
	VSC2 @ 18"	q	1314	1181	1230	1163	1115	1156	1120	1092	1124
		F	3.4+59R	5.6+39R	6.2+29R	7.2+23R	7.9+19R	7.9+16R	8.3+14R	8.7+13R	8.6+11R
	VSC2 @ 12"	q	1487	1448	1427	1414	1406	1399	1394	1387	1124
		F	2.7+59R	4.4+39R	5.2+30R	5.8+24R	6.1+20R	6.4+17R	6.6+15R	6.8+13R	6.9+12R
	VSC2 @ 8"	q	1701	1681	1670	1663	1659	1655	1653	1387	1124
		F	1.9+60R	3.3+40R	4.1+30R	4.5+24R	4.8+20R	5.1+17R	5.2+15R	5.4+13R	5.5+12R
	VSC2 @ 6"	q	1816	1805	1799	1795	1793	1791	1756	1387	1124
		F	1.4+60R	2.8+40R	3.4+30R	3.9+24R	4.2+20R	4.4+17R	4.5+15R	4.6+13R	4.7+12R
	VSC2 @ 4"	q	1924	1920	1918	1916	1915	1915	1756	1387	1124
		F	0.8+60R	2.1+40R	2.8+30R	3.2+24R	3.4+20R	3.6+17R	3.7+15R	3.9+13R	3.9+12R
16	VSC2 @ 24"	q	1394	1307	1262	1233	1214	1200	1190	1181	1175
		F	4.7+33R	6.2+22R	7.1+16R	7.7+13R	8.2+10R	8.5+9R	8.7+8R	9+7R	9.1+6R
	VSC2 @ 18"	q	1696	1539	1603	1522	1464	1515	1473	1438	1478
		F	3.8+34R	5.3+22R	5.7+16R	6.4+13R	6.9+11R	6.8+9R	7.2+8R	7.4+7R	7.3+6R
	VSC2 @ 12"	q	1906	1864	1842	1828	1818	1811	1806	1802	1568
		F	3.2+34R	4.3+22R	4.8+17R	5.2+13R	5.4+11R	5.6+9R	5.7+8R	5.8+7R	5.9+7R
	VSC2 @ 8"	q	2154	2133	2122	2116	2111	2107	2105	1936	1568
		F	2.5+34R	3.4+23R	3.8+17R	4.1+14R	4.3+11R	4.4+10R	4.5+8R	4.6+8R	4.7+7R
	VSC2 @ 6"	q	2283	2271	2265	2262	2259	2258	2256	1936	1568
		F	2+34R	2.9+23R	3.3+17R	3.5+14R	3.7+11R	3.8+10R	3.9+9R	4+8R	4+7R
	VSC2 @ 4"	q	2399	2395	2393	2392	2391	2390	2390	1936	1568
		F	1.5+34R	2.3+23R	2.7+17R	2.9+14R	3.1+11R	3.2+10R	3.3+9R	3.3+8R	3.4+7R

See footnotes on page 106.

Type PLN™ -24

- 24/4 Pneutek Fastener Pattern at Supports
SDK61 at Supports 0.113 to 0.155" thick
- Sidelaps Connected with PunchLok II Tool



Allowable Diaphragm Shear Strength, q (plf) and Flexibility Factors, F ((in./lb)x10⁶)

DECK GAGE	SIDELAP ATTACHMENT	SPAN (ft.-in.)									
		4'-0"	6'-0"	8'-0"	10'-0"	12'-0"	14'-0"	16'-0"	18'-0"	20'-0"	
22	VSC2 @ 24"	q	563	511	484	467	456	448	442	437	433
		F	11+190R	17.4+126R	20.9+94R	23.1+75R	24.6+62R	25.7+53R	26.5+46R	27.2+41R	27.7+37R
	VSC2 @ 18"	q	696	610	632	591	562	583	562	545	559
		F	6.6+192R	13.4+127R	14.7+95R	17.4+76R	19.4+63R	19.1+54R	20.4+47R	21.5+42R	21+38R
	VSC2 @ 12"	q	801	769	751	740	733	728	724	690	559
		F	3.9+193R	8.8+128R	11.2+96R	12.7+77R	13.7+64R	14.5+55R	15+48R	15.4+43R	15.8+38R
	VSC2 @ 8"	q	947	927	917	910	906	903	873	690	559
		F	0.8+194R	5.2+129R	7.5+97R	8.8+77R	9.7+64R	10.3+55R	10.8+48R	11.2+43R	11.5+39R
	VSC2 @ 6"	q	1035	1023	1017	1013	1010	1008	873	690	559
		F	-0.9+194R	3.3+129R	5.5+97R	6.7+78R	7.6+65R	8.2+55R	8.7+48R	9+43R	9.3+39R
	VSC2 @ 4"	q	1127	1122	1119	1117	1116	1115	873	690	559
		F	-2.8+195R	1.3+130R	3.4+97R	4.6+78R	5.4+65R	6+56R	6.5+49R	6.8+43R	7.1+39R
20	VSC2 @ 24"	q	726	669	639	621	608	599	592	587	583
		F	10.5+120R	14.5+80R	16.7+59R	18.1+47R	19+39R	19.7+34R	20.2+29R	20.6+26R	20.9+23R
	VSC2 @ 18"	q	894	796	828	779	744	771	746	726	734
		F	6.8+122R	11.4+80R	11.9+60R	13.7+48R	15.1+40R	14.8+34R	15.6+30R	16.3+27R	16+24R
	VSC2 @ 12"	q	1020	988	971	960	953	947	943	906	734
		F	4.7+122R	7.8+81R	9.3+61R	10.2+49R	10.8+41R	11.3+35R	11.6+30R	11.9+27R	12.1+24R
	VSC2 @ 8"	q	1184	1166	1156	1150	1146	1143	1141	906	734
		F	2.3+123R	5.1+82R	6.5+61R	7.3+49R	7.9+41R	8.3+35R	8.6+31R	8.8+27R	9+25R
	VSC2 @ 6"	q	1276	1266	1260	1257	1254	1253	1146	906	734
		F	1+123R	3.7+82R	5+61R	5.8+49R	6.4+41R	6.7+35R	7+31R	7.3+27R	7.4+25R
	VSC2 @ 4"	q	1366	1362	1360	1358	1357	1357	1146	906	734
		F	-0.4+123R	2.2+82R	3.5+62R	4.3+49R	4.8+41R	5.2+35R	5.4+31R	5.7+27R	5.8+25R
18	VSC2 @ 24"	q	1038	971	936	914	899	889	880	874	869
		F	7.4+59R	9.2+39R	10.2+29R	10.7+23R	11.1+19R	11.4+17R	11.6+15R	11.8+13R	11.9+12R
	VSC2 @ 18"	q	1265	1145	1193	1131	1087	1125	1093	1067	1096
		F	5.1+60R	7.3+40R	7.4+30R	8.3+24R	8.9+20R	8.7+17R	9.1+15R	9.5+13R	9.2+12R
	VSC2 @ 12"	q	1425	1392	1374	1363	1356	1350	1346	1343	1124
		F	3.8+60R	5.2+40R	5.9+30R	6.4+24R	6.7+20R	6.9+17R	7+15R	7.1+13R	7.2+12R
	VSC2 @ 8"	q	1616	1599	1590	1585	1581	1578	1576	1387	1124
		F	2.5+60R	3.8+40R	4.4+30R	4.8+24R	5.1+20R	5.3+17R	5.4+15R	5.5+13R	5.6+12R
	VSC2 @ 6"	q	1716	1707	1702	1699	1697	1695	1694	1387	1124
		F	1.7+60R	3+40R	3.6+30R	4+24R	4.3+20R	4.5+17R	4.6+15R	4.7+13R	4.8+12R
	VSC2 @ 4"	q	1807	1804	1802	1801	1800	1800	1756	1387	1124
		F	1+60R	2.2+40R	2.9+30R	3.2+24R	3.5+20R	3.7+17R	3.8+15R	3.9+13R	4+12R
16	VSC2 @ 24"	q	1338	1263	1223	1199	1182	1170	1161	1153	1148
		F	7.2+33R	8.3+22R	8.9+17R	9.3+13R	9.5+11R	9.7+9R	9.9+8R	10+7R	10.1+7R
	VSC2 @ 18"	q	1618	1478	1540	1468	1415	1463	1425	1393	1430
		F	5.2+34R	6.7+22R	6.6+17R	7.2+13R	7.7+11R	7.5+10R	7.8+8R	8+7R	7.8+7R
	VSC2 @ 12"	q	1805	1771	1753	1742	1734	1729	1724	1721	1568
		F	4.1+34R	4.9+23R	5.4+17R	5.6+14R	5.8+11R	5.9+10R	6+9R	6.1+8R	6.1+7R
	VSC2 @ 8"	q	2019	2003	1995	1989	1986	1983	1981	1936	1568
		F	2.9+34R	3.7+23R	4.1+17R	4.3+14R	4.5+11R	4.6+10R	4.7+9R	4.7+8R	4.8+7R
	VSC2 @ 6"	q	2127	2118	2114	2111	2109	2108	2107	1936	1568
		F	2.3+34R	3.1+23R	3.4+17R	3.7+14R	3.8+11R	3.9+10R	4+9R	4+8R	4.1+7R
	VSC2 @ 4"	q	2222	2219	2217	2216	2215	2215	2215	1936	1568
		F	1.7+34R	2.4+23R	2.8+17R	3+14R	3.1+11R	3.2+10R	3.3+9R	3.4+8R	3.4+7R

See footnotes on page 106.

Type PLN™ -24

- 24/6 Pneutek Fastener Pattern at Supports
SDK61 at Supports 0.113 to 0.155" thick
- Sidelaps Connected with PunchLok II Tool

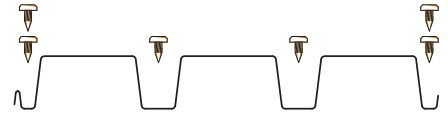

Allowable Diaphragm Shear Strength, q (plf) and Flexibility Factors, F ((in./lb)x10⁶)

DECK GAGE	SIDELAP ATTACHMENT	SPAN (ft-in.)									
		4'-0"	6'-0"	8'-0"	10'-0"	12'-0"	14'-0"	16'-0"	18'-0"	20'-0"	
22	VSC2 @ 24"	q	751	645	589	554	531	514	501	491	483
		F	7.2+190R	14+125R	17.9+93R	20.4+74R	22.2+61R	23.5+52R	24.5+45R	25.4+40R	26+36R
	VSC2 @ 18"	q	901	756	758	694	650	667	636	613	559
		F	4.3+192R	11.1+127R	13.1+95R	15.8+75R	17.9+62R	18+54R	19.3+47R	20.4+41R	20.1+37R
	VSC2 @ 12"	q	1032	951	907	880	862	849	838	690	559
		F	2.4+193R	7.5+128R	10.2+96R	11.9+76R	13+64R	13.8+54R	14.4+48R	14.9+42R	15.3+38R
	VSC2 @ 8"	q	*1237	1179	1147	1128	1114	1104	873	690	559
		F	0+194R	4.6+129R	7+96R	8.4+77R	9.3+64R	10+55R	10.5+48R	11+43R	11.3+38R
	VSC2 @ 6"	q	*1385	*1343	*1321	*1306	*1297	1140	873	690	559
		F	-1.4+194R	3+129R	5.2+97R	6.5+77R	7.4+65R	8+55R	8.5+48R	8.9+43R	9.2+39R
	VSC2 @ 4"	q	*1566	*1544	*1533	*1525	*1520	1140	873	690	559
		F	-3+194R	1.1+130R	3.2+97R	4.5+78R	5.3+65R	5.9+55R	6.4+49R	6.7+43R	7+39R
20	VSC2 @ 24"	q	955	835	771	731	704	685	670	659	650
		F	7.9+120R	12.3+79R	14.8+59R	16.4+47R	17.5+39R	18.4+33R	19+29R	19.5+25R	19.9+23R
	VSC2 @ 18"	q	1152	982	995	917	863	888	851	821	734
		F	5.4+121R	9.9+80R	10.9+60R	12.8+48R	14.2+39R	14.1+34R	15+30R	15.7+26R	15.4+24R
	VSC2 @ 12"	q	1317	1232	1185	1157	1137	1123	1112	906	734
		F	3.8+122R	7+81R	8.7+61R	9.7+48R	10.4+40R	10.9+34R	11.3+30R	11.6+27R	11.8+24R
	VSC2 @ 8"	q	*1566	*1508	*1476	*1457	*1443	*1433	1146	906	734
		F	1.8+122R	4.7+82R	6.2+61R	7.1+49R	7.7+41R	8.1+35R	8.4+31R	8.7+27R	8.9+24R
	VSC2 @ 6"	q	*1733	*1694	*1673	*1660	*1651	*1497	1146	906	734
		F	0.7+123R	3.5+82R	4.8+61R	5.7+49R	6.2+41R	6.6+35R	6.9+31R	7.2+27R	7.4+25R
	VSC2 @ 4"	q	*1925	*1907	*1897	*1890	*1886	*1497	1146	906	734
		F	-0.5+123R	2.1+82R	3.4+62R	4.2+49R	4.7+41R	5.1+35R	5.4+31R	5.6+27R	5.8+25R
18	VSC2 @ 24"	q	1348	1201	1122	1074	1041	1017	999	985	973
		F	6.4+59R	8.4+39R	9.5+29R	10.2+23R	10.6+19R	11+16R	11.2+14R	11.4+13R	11.6+11R
	VSC2 @ 18"	q	1630	1414	1445	1344	1272	1313	1263	1222	1124
		F	4.6+59R	6.8+39R	7.1+30R	8+24R	8.6+20R	8.5+17R	8.9+15R	9.3+13R	9.1+12R
	VSC2 @ 12"	q	1855	1760	1708	1676	1654	1638	1625	1387	1124
		F	3.5+60R	5+40R	5.7+30R	6.2+24R	6.5+20R	6.7+17R	6.9+15R	7+13R	7.1+12R
	VSC2 @ 8"	q	*2173	*2114	*2082	*2062	*2048	*2038	1756	1387	1124
		F	2.3+60R	3.7+40R	4.3+30R	4.7+24R	5+20R	5.2+17R	5.4+15R	5.5+13R	5.6+12R
	VSC2 @ 6"	q	*2371	*2334	*2314	*2302	*2293	*2287	1756	1387	1124
		F	1.6+60R	2.9+40R	3.6+30R	4+24R	4.3+20R	4.4+17R	4.6+15R	4.7+13R	4.8+12R
	VSC2 @ 4"	q	*2584	*2567	*2558	*2553	*2549	*2294	1756	1387	1124
		F	0.9+60R	2.2+40R	2.8+30R	3.2+24R	3.5+20R	3.6+17R	3.8+15R	3.9+13R	4+12R
16	VSC2 @ 24"	q	1729	1558	1466	1410	1371	1343	1322	1305	1292
		F	6.3+33R	7.7+22R	8.4+16R	8.8+13R	9.2+11R	9.4+9R	9.6+8R	9.7+7R	9.8+6R
	VSC2 @ 18"	q	2089	1832	1882	1759	1671	1726	1664	1614	1568
		F	4.8+34R	6.3+22R	6.3+17R	7+13R	7.5+11R	7.3+9R	7.6+8R	7.9+7R	7.7+7R
	VSC2 @ 12"	q	*2368	2264	2208	2173	2149	2131	2118	1936	1568
		F	3.8+34R	4.7+23R	5.2+17R	5.5+14R	5.7+11R	5.8+10R	5.9+8R	6+7R	6.1+7R
	VSC2 @ 8"	q	*2745	*2684	*2651	*2630	*2616	*2606	*2450	1936	1568
		F	2.8+34R	3.6+23R	4+17R	4.3+14R	4.4+11R	4.5+10R	4.6+9R	4.7+8R	4.8+7R
	VSC2 @ 6"	q	*2969	*2933	*2913	*2900	*2892	*2886	*2450	1936	1568
		F	2.2+34R	3+23R	3.4+17R	3.6+14R	3.8+11R	3.9+10R	4+9R	4+8R	4.1+7R
	VSC2 @ 4"	q	*3199	*3184	*3176	*3171	*3167	*3165	*2450	1936	1568
		F	1.6+34R	2.4+23R	2.7+17R	3+14R	3.1+11R	3.2+10R	3.3+9R	3.4+8R	3.4+7R

1. For diaphragm shear strengths in bold and marked with *, the fastening pattern shall be increased at the building perimeter, chords, collectors to other shear transfer elements to two fasteners per rib (i.e. 24/8 pattern) or shall be limited to 1200 plf, 1400 plf, 1900 plf or 2300 plf for 22, 20, 18 or 16 gage steel deck, respectively. Bearing at supports shall allow for proper end distance and fastener spacing.
2. See footnotes on page 106.

Type PLN™ -24

- 24/4 Pneutek Fastener Pattern at Supports
SDK63 at Supports 0.155 to 0.250" thick
- Sidelaps Connected with PunchLok II Tool



Allowable Diaphragm Shear Strength, q (plf) and Flexibility Factors, F ((in./lb)x10⁶)

DECK GAGE	SIDELAP ATTACHMENT	SPAN (ft.-in.)									
		4'-0"	6'-0"	8'-0"	10'-0"	12'-0"	14'-0"	16'-0"	18'-0"	20'-0"	
22	VSC2 @ 24"	q	593	533	502	482	469	460	453	447	443
		F	11+190R	17.4+126R	20.9+94R	23.1+75R	24.6+62R	25.7+53R	26.5+46R	27.2+41R	27.7+37R
	VSC2 @ 18"	q	734	637	658	612	580	601	578	560	559
		F	6.6+192R	13.4+127R	14.7+95R	17.4+76R	19.4+63R	19.1+54R	20.4+47R	21.5+42R	21+38R
	VSC2 @ 12"	q	850	809	788	774	765	759	754	690	559
		F	3.9+193R	8.8+128R	11.2+96R	12.7+77R	13.7+64R	14.5+55R	15+48R	15.4+43R	15.8+38R
	VSC2 @ 8"	q	1016	990	976	967	962	957	873	690	559
		F	0.8+194R	5.2+129R	7.5+97R	8.8+77R	9.7+64R	10.3+55R	10.8+48R	11.2+43R	11.5+39R
	VSC2 @ 6"	q	1121	1105	1096	1091	1087	1084	873	690	559
		F	-0.9+194R	3.3+129R	5.5+97R	6.7+78R	7.6+65R	8.2+55R	8.7+48R	9+43R	9.3+39R
VSC2 @ 4"	q	1236	1228	1225	1222	1221	1140	873	690	559	
	F	-2.8+195R	1.3+130R	3.4+97R	4.6+78R	5.4+65R	6+56R	6.5+49R	6.8+43R	7.1+39R	
20	VSC2 @ 24"	q	753	689	656	635	621	611	603	597	592
		F	10.5+120R	14.5+80R	16.7+59R	18.1+47R	19+39R	19.7+34R	20.2+29R	20.6+26R	20.9+23R
	VSC2 @ 18"	q	929	821	853	800	762	791	763	742	734
		F	6.8+122R	11.4+80R	11.9+60R	13.7+48R	15.1+40R	14.8+34R	15.6+30R	16.3+27R	16+24R
	VSC2 @ 12"	q	1065	1027	1007	994	985	979	974	906	734
		F	4.7+122R	7.8+81R	9.3+61R	10.2+49R	10.8+41R	11.3+35R	11.6+30R	11.9+27R	12.1+24R
	VSC2 @ 8"	q	1247	1225	1213	1206	1201	1197	1146	906	734
		F	2.3+123R	5.1+82R	6.5+61R	7.3+49R	7.9+41R	8.3+35R	8.6+31R	8.8+27R	9+25R
	VSC2 @ 6"	q	1353	1340	1333	1328	1325	1323	1146	906	734
		F	1+123R	3.7+82R	5+61R	5.8+49R	6.4+41R	6.7+35R	7+31R	7.3+27R	7.4+25R
VSC2 @ 4"	q	1459	1454	1451	1449	1448	1447	1146	906	734	
	F	-0.4+123R	2.2+82R	3.5+62R	4.3+49R	4.8+41R	5.2+35R	5.4+31R	5.7+27R	5.8+25R	
18	VSC2 @ 24"	q	1046	978	941	919	904	893	885	878	873
		F	7.4+59R	9.2+39R	10.2+29R	10.7+23R	11.1+19R	11.4+17R	11.6+15R	11.8+13R	11.9+12R
	VSC2 @ 18"	q	1277	1153	1202	1139	1094	1133	1100	1073	1103
		F	5.1+60R	7.3+40R	7.4+30R	8.3+24R	8.9+20R	8.7+17R	9.1+15R	9.5+13R	9.2+12R
	VSC2 @ 12"	q	1439	1405	1387	1375	1367	1362	1358	1354	1124
		F	3.8+60R	5.2+40R	5.9+30R	6.4+24R	6.7+20R	6.9+17R	7+15R	7.1+13R	7.2+12R
	VSC2 @ 8"	q	1636	1618	1609	1603	1599	1597	1594	1387	1124
		F	2.5+60R	3.8+40R	4.4+30R	4.8+24R	5.1+20R	5.3+17R	5.4+15R	5.5+13R	5.6+12R
	VSC2 @ 6"	q	1739	1730	1725	1722	1719	1718	1717	1387	1124
		F	1.7+60R	3+40R	3.6+30R	4+24R	4.3+20R	4.5+17R	4.6+15R	4.7+13R	4.8+12R
VSC2 @ 4"	q	1835	1831	1829	1828	1827	1827	1756	1387	1124	
	F	1+60R	2.2+40R	2.9+30R	3.2+24R	3.5+20R	3.7+17R	3.8+15R	3.9+13R	4+12R	
16	VSC2 @ 24"	q	1319	1247	1210	1186	1170	1159	1150	1143	1138
		F	7.2+33R	8.3+22R	8.9+17R	9.3+13R	9.5+11R	9.7+9R	9.9+8R	10+7R	10.1+7R
	VSC2 @ 18"	q	1590	1457	1517	1448	1398	1444	1407	1377	1413
		F	5.2+34R	6.7+22R	6.6+17R	7.2+13R	7.7+11R	7.5+10R	7.8+8R	8+7R	7.8+7R
	VSC2 @ 12"	q	1770	1739	1722	1712	1705	1699	1696	1693	1568
		F	4.1+34R	4.9+23R	5.4+17R	5.6+14R	5.8+11R	5.9+10R	6+9R	6.1+8R	6.1+7R
	VSC2 @ 8"	q	1974	1959	1951	1946	1943	1941	1939	1936	1568
		F	2.9+34R	3.7+23R	4.1+17R	4.3+14R	4.5+11R	4.6+10R	4.7+9R	4.7+8R	4.8+7R
	VSC2 @ 6"	q	2074	2066	2062	2060	2058	2057	2056	1936	1568
		F	2.3+34R	3.1+23R	3.4+17R	3.7+14R	3.8+11R	3.9+10R	4+9R	4+8R	4.1+7R
VSC2 @ 4"	q	2163	2160	2158	2157	2157	2156	2156	1936	1568	
	F	1.7+34R	2.4+23R	2.8+17R	3+14R	3.1+11R	3.2+10R	3.3+9R	3.4+8R	3.4+7R	

See footnotes on page 106.

Type PLN™ -24

- 24/6 Pneutek Fastener Pattern at Supports
SDK63 at Supports 0.155 to 0.250" thick
- Sidelaps Connected with PunchLok II Tool

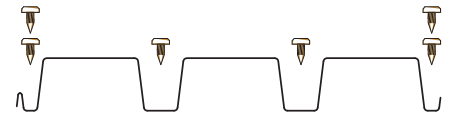

Allowable Diaphragm Shear Strength, q (plf) and Flexibility Factors, F ((in./lb)x10⁶)

DECK GAGE	SIDELAP ATTACHMENT	SPAN (ft-in.)									
		4'-0"	6'-0"	8'-0"	10'-0"	12'-0"	14'-0"	16'-0"	18'-0"	20'-0"	
22	VSC2 @ 24"	q	801	673	610	572	546	528	515	504	495
		F	7.2+190R	14+125R	17.9+93R	20.4+74R	22.2+61R	23.5+52R	24.5+45R	25.4+40R	26+36R
	VSC2 @ 18"	q	957	794	790	720	671	687	654	628	559
		F	4.3+192R	11.1+127R	13.1+95R	15.8+75R	17.9+62R	18+54R	19.3+47R	20.4+41R	20.1+37R
	VSC2 @ 12"	q	1094	998	947	915	893	877	865	690	559
		F	2.4+193R	7.5+128R	10.2+96R	11.9+76R	13+64R	13.8+54R	14.4+48R	14.9+42R	15.3+38R
	VSC2 @ 8"	q	*1319	1246	1207	1182	1165	1140	873	690	559
		F	0+194R	4.6+129R	7+96R	8.4+77R	9.3+64R	10+55R	10.5+48R	11+43R	11.3+38R
	VSC2 @ 6"	q	*1485	*1432	*1402	*1384	*1372	1140	873	690	559
		F	-1.4+194R	3+129R	5.2+97R	6.5+77R	7.4+65R	8+55R	8.5+48R	8.9+43R	9.2+39R
	VSC2 @ 4"	q	*1700	*1670	*1654	*1644	*1552	1140	873	690	559
		F	-3+194R	1.1+130R	3.2+97R	4.5+78R	5.3+65R	5.9+55R	6.4+49R	6.7+43R	7+39R
20	VSC2 @ 24"	q	997	863	793	750	720	699	683	670	660
		F	7.9+120R	12.3+79R	14.8+59R	16.4+47R	17.5+39R	18.4+33R	19+29R	19.5+25R	19.9+23R
	VSC2 @ 18"	q	1200	1014	1023	940	882	907	868	836	734
		F	5.4+121R	9.9+80R	10.9+60R	12.8+48R	14.2+39R	14.1+34R	15+30R	15.7+26R	15.4+24R
	VSC2 @ 12"	q	1373	1275	1222	1189	1167	1151	1139	906	734
		F	3.8+122R	7+81R	8.7+61R	9.7+48R	10.4+40R	10.9+34R	11.3+30R	11.6+27R	11.8+24R
	VSC2 @ 8"	q	*1639	*1571	*1534	*1511	1495	1483	1146	906	734
		F	1.8+122R	4.7+82R	6.2+61R	7.1+49R	7.7+41R	8.1+35R	8.4+31R	8.7+27R	8.9+24R
	VSC2 @ 6"	q	*1824	*1777	*1751	*1735	*1724	1497	1146	906	734
		F	0.7+123R	3.5+82R	4.8+61R	5.7+49R	6.2+41R	6.6+35R	6.9+31R	7.2+27R	7.4+25R
	VSC2 @ 4"	q	*2043	*2020	*2007	*1999	*1994	1497	1146	906	734
		F	-0.5+123R	2.1+82R	3.4+62R	4.2+49R	4.7+41R	5.1+35R	5.4+31R	5.6+27R	5.8+25R
18	VSC2 @ 24"	q	1360	1209	1129	1079	1046	1021	1003	988	977
		F	6.4+59R	8.4+39R	9.5+29R	10.2+23R	10.6+19R	11+16R	11.2+14R	11.4+13R	11.6+11R
	VSC2 @ 18"	q	1644	1424	1455	1352	1279	1320	1269	1228	1124
		F	4.6+59R	6.8+39R	7.1+30R	8+24R	8.6+20R	8.5+17R	8.9+15R	9.3+13R	9.1+12R
	VSC2 @ 12"	q	1872	1774	1721	1687	1665	1648	1636	1387	1124
		F	3.5+60R	5+40R	5.7+30R	6.2+24R	6.5+20R	6.7+17R	6.9+15R	7+13R	7.1+12R
	VSC2 @ 8"	q	*2196	*2135	*2102	*2081	*2066	*2056	1756	1387	1124
		F	2.3+60R	3.7+40R	4.3+30R	4.7+24R	5+20R	5.2+17R	5.4+15R	5.5+13R	5.6+12R
	VSC2 @ 6"	q	*2400	*2361	*2340	*2327	*2318	*2294	1756	1387	1124
		F	1.6+60R	2.9+40R	3.6+30R	4+24R	4.3+20R	4.4+17R	4.6+15R	4.7+13R	4.8+12R
	VSC2 @ 4"	q	*2619	*2602	*2593	*2587	*2583	*2294	1756	1387	1124
		F	0.9+60R	2.2+40R	2.8+30R	3.2+24R	3.5+20R	3.6+17R	3.8+15R	3.9+13R	4+12R
16	VSC2 @ 24"	q	1703	1538	1451	1396	1359	1332	1312	1296	1283
		F	6.3+33R	7.7+22R	8.4+16R	8.8+13R	9.2+11R	9.4+9R	9.6+8R	9.7+7R	9.8+6R
	VSC2 @ 18"	q	2056	1809	1859	1740	1655	1709	1649	1600	1568
		F	4.8+34R	6.3+22R	6.3+17R	7+13R	7.5+11R	7.3+9R	7.6+8R	7.9+7R	7.7+7R
	VSC2 @ 12"	q	*2327	*2230	2177	2144	2121	2104	2092	1936	1568
		F	3.8+34R	4.7+23R	5.2+17R	5.5+14R	5.7+11R	5.8+10R	5.9+8R	6+7R	6.1+7R
	VSC2 @ 8"	q	*2690	*2634	*2603	*2584	*2571	*2561	*2450	1936	1568
		F	2.8+34R	3.6+23R	4+17R	4.3+14R	4.4+11R	4.5+10R	4.6+9R	4.7+8R	4.8+7R
	VSC2 @ 6"	q	*2904	*2870	*2852	*2840	*2832	*2827	*2450	1936	1568
		F	2.2+34R	3+23R	3.4+17R	3.6+14R	3.8+11R	3.9+10R	4+9R	4+8R	4.1+7R
	VSC2 @ 4"	q	*3120	*3106	*3098	*3094	*3091	*3088	*2450	1936	1568
		F	1.6+34R	2.4+23R	2.7+17R	3+14R	3.1+11R	3.2+10R	3.3+9R	3.4+8R	3.4+7R

1. For diaphragm shear strengths in bold and marked with *, the fastening pattern shall be increased at the building perimeter, chords, collectors to other shear transfer elements to two fasteners per rib (i.e. 24/8 pattern) or shall be limited to 1300 plf, 1500 plf, 1900 plf or 2200 plf for 22, 20, 18 or 16 gage steel deck, respectively. Bearing at supports shall allow for proper end distance and fastener spacing.
 2. See footnotes on page 106.

Type PLN™ -24

- 24/4 Pneutek Fastener Pattern at Supports
K64 at Supports 0.187 to 0.312" thick
- Sidelaps Connected with PunchLok II Tool



Allowable Diaphragm Shear Strength, q (plf) and Flexibility Factors, F ((in./lb)x10⁶)

DECK GAGE	SIDELAP ATTACHMENT	SPAN (ft.-in.)									
		4'-0"	6'-0"	8'-0"	10'-0"	12'-0"	14'-0"	16'-0"	18'-0"	20'-0"	
22	VSC2 @ 24"	q	594	534	502	483	470	460	453	447	443
		F	11+190R	17.4+126R	20.9+94R	23.1+75R	24.6+62R	25.7+53R	26.5+46R	27.2+41R	27.7+37R
	VSC2 @ 18"	q	736	638	659	613	580	602	579	560	559
		F	6.6+192R	13.4+127R	14.7+95R	17.4+76R	19.4+63R	19.1+54R	20.4+47R	21.5+42R	21+38R
	VSC2 @ 12"	q	851	810	789	775	766	760	755	690	559
		F	3.9+193R	8.8+128R	11.2+96R	12.7+77R	13.7+64R	14.5+55R	15+48R	15.4+43R	15.8+38R
	VSC2 @ 8"	q	1018	992	978	969	963	959	873	690	559
		F	0.8+194R	5.2+129R	7.5+97R	8.8+77R	9.7+64R	10.3+55R	10.8+48R	11.2+43R	11.5+39R
	VSC2 @ 6"	q	1124	1107	1099	1093	1089	1087	873	690	559
		F	-0.9+194R	3.3+129R	5.5+97R	6.7+78R	7.6+65R	8.2+55R	8.7+48R	9+43R	9.3+39R
VSC2 @ 4"	q	1239	1232	1228	1226	1224	1140	873	690	559	
	F	-2.8+195R	1.3+130R	3.4+97R	4.6+78R	5.4+65R	6+56R	6.5+49R	6.8+43R	7.1+39R	
20	VSC2 @ 24"	q	795	720	680	656	640	628	619	612	607
		F	10.5+120R	14.5+80R	16.7+59R	18.1+47R	19+39R	19.7+34R	20.2+29R	20.6+26R	20.9+23R
	VSC2 @ 18"	q	983	859	890	831	789	818	788	764	734
		F	6.8+122R	11.4+80R	11.9+60R	13.7+48R	15.1+40R	14.8+34R	15.6+30R	16.3+27R	16+24R
	VSC2 @ 12"	q	1133	1085	1059	1044	1033	1025	1019	906	734
		F	4.7+122R	7.8+81R	9.3+61R	10.2+49R	10.8+41R	11.3+35R	11.6+30R	11.9+27R	12.1+24R
	VSC2 @ 8"	q	1343	1314	1298	1288	1282	1277	1146	906	734
		F	2.3+123R	5.1+82R	6.5+61R	7.3+49R	7.9+41R	8.3+35R	8.6+31R	8.8+27R	9+25R
	VSC2 @ 6"	q	1472	1454	1444	1438	1434	1431	1146	906	734
		F	1+123R	3.7+82R	5+61R	5.8+49R	6.4+41R	6.7+35R	7+31R	7.3+27R	7.4+25R
VSC2 @ 4"	q	1608	1600	1596	1593	1591	1497	1146	906	734	
	F	-0.4+123R	2.2+82R	3.5+62R	4.3+49R	4.8+41R	5.2+35R	5.4+31R	5.7+27R	5.8+25R	
18	VSC2 @ 24"	q	1161	1065	1014	983	962	947	935	926	919
		F	7.4+59R	9.2+39R	10.2+29R	10.7+23R	11.1+19R	11.4+17R	11.6+15R	11.8+13R	11.9+12R
	VSC2 @ 18"	q	1432	1268	1317	1237	1180	1223	1182	1149	1124
		F	5.1+60R	7.3+40R	7.4+30R	8.3+24R	8.9+20R	8.7+17R	9.1+15R	9.5+13R	9.2+12R
	VSC2 @ 12"	q	1638	1582	1552	1533	1520	1511	1504	1387	1124
		F	3.8+60R	5.2+40R	5.9+30R	6.4+24R	6.7+20R	6.9+17R	7+15R	7.1+13R	7.2+12R
	VSC2 @ 8"	q	1912	1880	1863	1852	1845	1840	1756	1387	1124
		F	2.5+60R	3.8+40R	4.4+30R	4.8+24R	5.1+20R	5.3+17R	5.4+15R	5.5+13R	5.6+12R
	VSC2 @ 6"	q	2071	2052	2041	2035	2031	2028	1756	1387	1124
		F	1.7+60R	3+40R	3.6+30R	4+24R	4.3+20R	4.5+17R	4.6+15R	4.7+13R	4.8+12R
VSC2 @ 4"	q	2228	2220	2216	2214	2212	2211	1756	1387	1124	
	F	1+60R	2.2+40R	2.9+30R	3.2+24R	3.5+20R	3.7+17R	3.8+15R	3.9+13R	4+12R	
16	VSC2 @ 24"	q	1503	1392	1333	1297	1272	1254	1241	1230	1222
		F	7.2+33R	8.3+22R	8.9+17R	9.3+13R	9.5+11R	9.7+9R	9.9+8R	10+7R	10.1+7R
	VSC2 @ 18"	q	1847	1651	1719	1621	1551	1608	1557	1516	1561
		F	5.2+34R	6.7+22R	6.6+17R	7.2+13R	7.7+11R	7.5+10R	7.8+8R	8+7R	7.8+7R
	VSC2 @ 12"	q	2099	2038	2006	1986	1972	1962	1954	1936	1568
		F	4.1+34R	4.9+23R	5.4+17R	5.6+14R	5.8+11R	5.9+10R	6+9R	6.1+8R	6.1+7R
	VSC2 @ 8"	q	2419	2386	2369	2358	2351	2345	2341	1936	1568
		F	2.9+34R	3.7+23R	4.1+17R	4.3+14R	4.5+11R	4.6+10R	4.7+9R	4.7+8R	4.8+7R
	VSC2 @ 6"	q	2596	2577	2567	2561	2557	2554	2450	1936	1568
		F	2.3+34R	3.1+23R	3.4+17R	3.7+14R	3.8+11R	3.9+10R	4+9R	4+8R	4.1+7R
VSC2 @ 4"	q	2765	2758	2754	2752	2750	2749	2450	1936	1568	
	F	1.7+34R	2.4+23R	2.8+17R	3+14R	3.1+11R	3.2+10R	3.3+9R	3.4+8R	3.4+7R	

See footnotes on page 106.

Type PLN™ -24

- 24/6 Pneutek Fastener Pattern at Supports
K64 at Supports 0.187 to 0.312" thick
- Sidelaps Connected with PunchLok II Tool

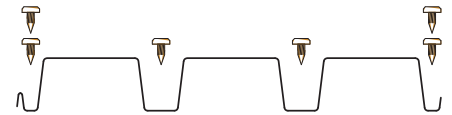

Allowable Diaphragm Shear Strength, q (plf) and Flexibility Factors, F ((in./lb)x10⁶)

DECK GAGE	SIDELAP ATTACHMENT	SPAN (ft-in.)									
		4'-0"	6'-0"	8'-0"	10'-0"	12'-0"	14'-0"	16'-0"	18'-0"	20'-0"	
22	VSC2 @ 24"	q	803	674	610	572	547	529	515	504	495
		F	7.2+190R	14+125R	17.9+93R	20.4+74R	22.2+61R	23.5+52R	24.5+45R	25.4+40R	26+36R
	VSC2 @ 18"	q	959	795	791	720	672	688	655	629	559
		F	4.3+192R	11.1+127R	13.1+95R	15.8+75R	17.9+62R	18+54R	19.3+47R	20.4+41R	20.1+37R
	VSC2 @ 12"	q	1097	1000	948	916	894	878	866	690	559
		F	2.4+193R	7.5+128R	10.2+96R	11.9+76R	13+64R	13.8+54R	14.4+48R	14.9+42R	15.3+38R
	VSC2 @ 8"	q	*1321	1248	1209	1184	1167	1140	873	690	559
		F	0+194R	4.6+129R	7+96R	8.4+77R	9.3+64R	10+55R	10.5+48R	11+43R	11.3+38R
	VSC2 @ 6"	q	*1489	*1434	*1405	*1387	*1374	1140	873	690	559
		F	-1.4+194R	3+129R	5.2+97R	6.5+77R	7.4+65R	8+55R	8.5+48R	8.9+43R	9.2+39R
	VSC2 @ 4"	q	*1704	*1674	*1658	*1648	*1552	1140	873	690	559
		F	-3+194R	1.1+130R	3.2+97R	4.5+78R	5.3+65R	5.9+55R	6.4+49R	6.7+43R	7+39R
20	VSC2 @ 24"	q	1063	909	828	779	745	721	703	688	677
		F	7.9+120R	12.3+79R	14.8+59R	16.4+47R	17.5+39R	18.4+33R	19+29R	19.5+25R	19.9+23R
	VSC2 @ 18"	q	1275	1066	1067	976	912	936	893	859	734
		F	5.4+121R	9.9+80R	10.9+60R	12.8+48R	14.2+39R	14.1+34R	15+30R	15.7+26R	15.4+24R
	VSC2 @ 12"	q	1459	1341	1278	1239	1212	1192	1146	906	734
		F	3.8+122R	7+81R	8.7+61R	9.7+48R	10.4+40R	10.9+34R	11.3+30R	11.6+27R	11.8+24R
	VSC2 @ 8"	q	*1752	*1666	*1619	1590	1570	1497	1146	906	734
		F	1.8+122R	4.7+82R	6.2+61R	7.1+49R	7.7+41R	8.1+35R	8.4+31R	8.7+27R	8.9+24R
	VSC2 @ 6"	q	*1964	*1902	*1869	*1848	*1833	1497	1146	906	734
		F	0.7+123R	3.5+82R	4.8+61R	5.7+49R	6.2+41R	6.6+35R	6.9+31R	7.2+27R	7.4+25R
	VSC2 @ 4"	q	*2228	*2196	*2178	*2167	*2038	1497	1146	906	734
		F	-0.5+123R	2.1+82R	3.4+62R	4.2+49R	4.7+41R	5.1+35R	5.4+31R	5.6+27R	5.8+25R
18	VSC2 @ 24"	q	1533	1332	1225	1159	1115	1083	1058	1039	1024
		F	6.4+59R	8.4+39R	9.5+29R	10.2+23R	10.6+19R	11+16R	11.2+14R	11.4+13R	11.6+11R
	VSC2 @ 18"	q	1847	1565	1581	1454	1366	1405	1345	1297	1124
		F	4.6+59R	6.8+39R	7.1+30R	8+24R	8.6+20R	8.5+17R	8.9+15R	9.3+13R	9.1+12R
	VSC2 @ 12"	q	2113	1966	1888	1838	1805	1781	1756	1387	1124
		F	3.5+60R	5+40R	5.7+30R	6.2+24R	6.5+20R	6.7+17R	6.9+15R	7+13R	7.1+12R
	VSC2 @ 8"	q	*2519	*2418	*2363	*2329	*2305	2288	1756	1387	1124
		F	2.3+60R	3.7+40R	4.3+30R	4.7+24R	5+20R	5.2+17R	5.4+15R	5.5+13R	5.6+12R
	VSC2 @ 6"	q	*2798	*2729	*2691	*2668	*2652	2294	1756	1387	1124
		F	1.6+60R	2.9+40R	3.6+30R	4+24R	4.3+20R	4.4+17R	4.6+15R	4.7+13R	4.8+12R
	VSC2 @ 4"	q	*3127	*3092	*3074	*3063	*3055	2294	1756	1387	1124
		F	0.9+60R	2.2+40R	2.8+30R	3.2+24R	3.5+20R	3.6+17R	3.8+15R	3.9+13R	4+12R
16	VSC2 @ 24"	q	1969	1730	1603	1525	1472	1433	1404	1382	1363
		F	6.3+33R	7.7+22R	8.4+16R	8.8+13R	9.2+11R	9.4+9R	9.6+8R	9.7+7R	9.8+6R
	VSC2 @ 18"	q	2378	2036	2069	1913	1803	1858	1782	1721	1568
		F	4.8+34R	6.3+22R	6.3+17R	7+13R	7.5+11R	7.3+9R	7.6+8R	7.9+7R	7.7+7R
	VSC2 @ 12"	q	2716	2550	2461	2405	2367	2340	2318	1936	1568
		F	3.8+34R	4.7+23R	5.2+17R	5.5+14R	5.7+11R	5.8+10R	5.9+8R	6+7R	6.1+7R
	VSC2 @ 8"	q	*3215	*3106	*3047	*3010	*2985	*2966	2450	1936	1568
		F	2.8+34R	3.6+23R	4+17R	4.3+14R	4.4+11R	4.5+10R	4.6+9R	4.7+8R	4.8+7R
	VSC2 @ 6"	q	*3544	*3472	*3433	*3409	*3392	*3200	2450	1936	1568
		F	2.2+34R	3+23R	3.4+17R	3.6+14R	3.8+11R	3.9+10R	4+9R	4+8R	4.1+7R
	VSC2 @ 4"	q	*3915	*3881	*3863	*3852	*3844	*3200	2450	1936	1568
		F	1.6+34R	2.4+23R	2.7+17R	3+14R	3.1+11R	3.2+10R	3.3+9R	3.4+8R	3.4+7R

1. For diaphragm shear strengths in bold and marked with *, the fastening pattern shall be increased at the building perimeter, chords, collectors to other shear transfer elements to two fasteners per rib (i.e. 24/8 pattern) or shall be limited to 1300 plf, 1600 plf, 2300 plf or 2600 plf for 22, 20, 18 or 16 gage steel deck, respectively. Bearing at supports shall allow for proper end distance and fastener spacing.
2. See footnotes on page 106.

Type PLN™ -24

- 24/4 Pneutek Fastener Pattern at Supports
K66 at Supports 0.281" and thicker
- Sidelaps Connected with PunchLok II Tool



Allowable Diaphragm Shear Strength, q (plf) and Flexibility Factors, F ((in./lb)x10⁶)

DECK GAGE	SIDELAP ATTACHMENT	SPAN (ft.-in.)									
		4'-0"	6'-0"	8'-0"	10'-0"	12'-0"	14'-0"	16'-0"	18'-0"	20'-0"	
22	VSC2 @ 24"	q	612	546	512	491	477	467	459	453	448
		F	11+190R	17.4+126R	20.9+94R	23.1+75R	24.6+62R	25.7+53R	26.5+46R	27.2+41R	27.7+37R
	VSC2 @ 18"	q	757	653	673	624	590	611	587	568	559
		F	6.6+192R	13.4+127R	14.7+95R	17.4+76R	19.4+63R	19.1+54R	20.4+47R	21.5+42R	21+38R
	VSC2 @ 12"	q	877	832	808	793	783	775	770	690	559
		F	3.9+193R	8.8+128R	11.2+96R	12.7+77R	13.7+64R	14.5+55R	15+48R	15.4+43R	15.8+38R
	VSC2 @ 8"	q	1055	1025	1009	999	993	988	873	690	559
		F	0.8+194R	5.2+129R	7.5+97R	8.8+77R	9.7+64R	10.3+55R	10.8+48R	11.2+43R	11.5+39R
	VSC2 @ 6"	q	1171	1152	1141	1135	1130	1127	873	690	559
		F	-0.9+194R	3.3+129R	5.5+97R	6.7+78R	7.6+65R	8.2+55R	8.7+48R	9+43R	9.3+39R
VSC2 @ 4"	q	1301	1292	1287	1284	1282	1140	873	690	559	
	F	-2.8+195R	1.3+130R	3.4+97R	4.6+78R	5.4+65R	6+56R	6.5+49R	6.8+43R	7.1+39R	
20	VSC2 @ 24"	q	802	725	684	660	643	631	622	615	609
		F	10.5+120R	14.5+80R	16.7+59R	18.1+47R	19+39R	19.7+34R	20.2+29R	20.6+26R	20.9+23R
	VSC2 @ 18"	q	992	866	896	836	793	822	792	768	734
		F	6.8+122R	11.4+80R	11.9+60R	13.7+48R	15.1+40R	14.8+34R	15.6+30R	16.3+27R	16+24R
	VSC2 @ 12"	q	1145	1095	1068	1052	1040	1032	1026	906	734
		F	4.7+122R	7.8+81R	9.3+61R	10.2+49R	10.8+41R	11.3+35R	11.6+30R	11.9+27R	12.1+24R
	VSC2 @ 8"	q	1359	1329	1312	1302	1295	1290	1146	906	734
		F	2.3+123R	5.1+82R	6.5+61R	7.3+49R	7.9+41R	8.3+35R	8.6+31R	8.8+27R	9+25R
	VSC2 @ 6"	q	1492	1473	1463	1457	1452	1449	1146	906	734
		F	1+123R	3.7+82R	5+61R	5.8+49R	6.4+41R	6.7+35R	7+31R	7.3+27R	7.4+25R
VSC2 @ 4"	q	1633	1625	1620	1617	1616	1497	1146	906	734	
	F	-0.4+123R	2.2+82R	3.5+62R	4.3+49R	4.8+41R	5.2+35R	5.4+31R	5.7+27R	5.8+25R	
18	VSC2 @ 24"	q	1183	1081	1028	995	972	956	944	935	927
		F	7.4+59R	9.2+39R	10.2+29R	10.7+23R	11.1+19R	11.4+17R	11.6+15R	11.8+13R	11.9+12R
	VSC2 @ 18"	q	1460	1288	1338	1254	1195	1239	1196	1162	1124
		F	5.1+60R	7.3+40R	7.4+30R	8.3+24R	8.9+20R	8.7+17R	9.1+15R	9.5+13R	9.2+12R
	VSC2 @ 12"	q	1675	1614	1581	1561	1547	1537	1529	1387	1124
		F	3.8+60R	5.2+40R	5.9+30R	6.4+24R	6.7+20R	6.9+17R	7+15R	7.1+13R	7.2+12R
	VSC2 @ 8"	q	1964	1929	1910	1898	1890	1884	1756	1387	1124
		F	2.5+60R	3.8+40R	4.4+30R	4.8+24R	5.1+20R	5.3+17R	5.4+15R	5.5+13R	5.6+12R
	VSC2 @ 6"	q	2134	2113	2102	2095	2090	2087	1756	1387	1124
		F	1.7+60R	3+40R	3.6+30R	4+24R	4.3+20R	4.5+17R	4.6+15R	4.7+13R	4.8+12R
VSC2 @ 4"	q	2306	2297	2293	2290	2288	2286	1756	1387	1124	
	F	1+60R	2.2+40R	2.9+30R	3.2+24R	3.5+20R	3.7+17R	3.8+15R	3.9+13R	4+12R	
16	VSC2 @ 24"	q	1577	1447	1379	1337	1308	1288	1272	1260	1250
		F	7.2+33R	8.3+22R	8.9+17R	9.3+13R	9.5+11R	9.7+9R	9.9+8R	10+7R	10.1+7R
	VSC2 @ 18"	q	1944	1722	1790	1681	1604	1663	1607	1562	1568
		F	5.2+34R	6.7+22R	6.6+17R	7.2+13R	7.7+11R	7.5+10R	7.8+8R	8+7R	7.8+7R
	VSC2 @ 12"	q	2224	2148	2108	2083	2066	2053	2044	1936	1568
		F	4.1+34R	4.9+23R	5.4+17R	5.6+14R	5.8+11R	5.9+10R	6+9R	6.1+8R	6.1+7R
	VSC2 @ 8"	q	2595	2551	2528	2514	2504	2497	2450	1936	1568
		F	2.9+34R	3.7+23R	4.1+17R	4.3+14R	4.5+11R	4.6+10R	4.7+9R	4.7+8R	4.8+7R
	VSC2 @ 6"	q	2808	2783	2769	2761	2755	2751	2450	1936	1568
		F	2.3+34R	3.1+23R	3.4+17R	3.7+14R	3.8+11R	3.9+10R	4+9R	4+8R	4.1+7R
VSC2 @ 4"	q	3020	3010	3004	3001	2999	2997	2450	1936	1568	
	F	1.7+34R	2.4+23R	2.8+17R	3+14R	3.1+11R	3.2+10R	3.3+9R	3.4+8R	3.4+7R	

See footnotes on page 106.

Type PLN™ -24

- 24/6 Pneutek Fastener Pattern at Supports
K66 at Supports 0.281" and thicker
- Sidelaps Connected with PunchLok II Tool

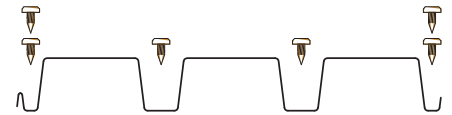

Allowable Diaphragm Shear Strength, q (plf) and Flexibility Factors, F ((in./lb)x10⁶)

DECK GAGE	SIDELAP ATTACHMENT	SPAN (ft-in.)									
		4'-0"	6'-0"	8'-0"	10'-0"	12'-0"	14'-0"	16'-0"	18'-0"	20'-0"	
22	VSC2 @ 24"	q	827	689	622	582	555	535	521	510	501
		F	7.2+190R	14+125R	17.9+93R	20.4+74R	22.2+61R	23.5+52R	24.5+45R	25.4+40R	26+36R
	VSC2 @ 18"	q	990	816	808	735	684	699	664	638	559
		F	4.3+192R	11.1+127R	13.1+95R	15.8+75R	17.9+62R	18+54R	19.3+47R	20.4+41R	20.1+37R
	VSC2 @ 12"	q	1132	1026	969	934	910	893	873	690	559
		F	2.4+193R	7.5+128R	10.2+96R	11.9+76R	13+64R	13.8+54R	14.4+48R	14.9+42R	15.3+38R
	VSC2 @ 8"	q	*1366	1284	1240	1213	1194	1140	873	690	559
		F	0+194R	4.6+129R	7+96R	8.4+77R	9.3+64R	10+55R	10.5+48R	11+43R	11.3+38R
	VSC2 @ 6"	q	*1544	*1482	*1448	*1428	*1413	1140	873	690	559
		F	-1.4+194R	3+129R	5.2+97R	6.5+77R	7.4+65R	8+55R	8.5+48R	8.9+43R	9.2+39R
	VSC2 @ 4"	q	*1778	*1743	*1724	*1712	*1552	1140	873	690	559
		F	-3+194R	1.1+130R	3.2+97R	4.5+78R	5.3+65R	5.9+55R	6.4+49R	6.7+43R	7+39R
20	VSC2 @ 24"	q	1075	915	833	783	750	725	706	691	680
		F	7.9+120R	12.3+79R	14.8+59R	16.4+47R	17.5+39R	18.4+33R	19+29R	19.5+25R	19.9+23R
	VSC2 @ 18"	q	1288	1075	1074	982	917	940	897	863	734
		F	5.4+121R	9.9+80R	10.9+60R	12.8+48R	14.2+39R	14.1+34R	15+30R	15.7+26R	15.4+24R
	VSC2 @ 12"	q	1474	1352	1287	1247	1219	1199	1146	906	734
		F	3.8+122R	7+81R	8.7+61R	9.7+48R	10.4+40R	10.9+34R	11.3+30R	11.6+27R	11.8+24R
	VSC2 @ 8"	q	*1771	1682	1633	1603	1582	1497	1146	906	734
		F	1.8+122R	4.7+82R	6.2+61R	7.1+49R	7.7+41R	8.1+35R	8.4+31R	8.7+27R	8.9+24R
	VSC2 @ 6"	q	*1988	*1923	*1888	*1866	*1851	1497	1146	906	734
		F	0.7+123R	3.5+82R	4.8+61R	5.7+49R	6.2+41R	6.6+35R	6.9+31R	7.2+27R	7.4+25R
	VSC2 @ 4"	q	*2260	*2225	*2206	*2195	*2038	1497	1146	906	734
		F	-0.5+123R	2.1+82R	3.4+62R	4.2+49R	4.7+41R	5.1+35R	5.4+31R	5.6+27R	5.8+25R
18	VSC2 @ 24"	q	1568	1356	1244	1175	1128	1095	1069	1049	1033
		F	6.4+59R	8.4+39R	9.5+29R	10.2+23R	10.6+19R	11+16R	11.2+14R	11.4+13R	11.6+11R
	VSC2 @ 18"	q	1886	1592	1604	1474	1383	1421	1358	1309	1124
		F	4.6+59R	6.8+39R	7.1+30R	8+24R	8.6+20R	8.5+17R	8.9+15R	9.3+13R	9.1+12R
	VSC2 @ 12"	q	2158	2002	1918	1865	1830	1804	1756	1387	1124
		F	3.5+60R	5+40R	5.7+30R	6.2+24R	6.5+20R	6.7+17R	6.9+15R	7+13R	7.1+12R
	VSC2 @ 8"	q	*2580	*2470	*2410	*2373	*2348	2294	1756	1387	1124
		F	2.3+60R	3.7+40R	4.3+30R	4.7+24R	5+20R	5.2+17R	5.4+15R	5.5+13R	5.6+12R
	VSC2 @ 6"	q	*2874	*2797	*2756	*2730	*2712	2294	1756	1387	1124
		F	1.6+60R	2.9+40R	3.6+30R	4+24R	4.3+20R	4.4+17R	4.6+15R	4.7+13R	4.8+12R
	VSC2 @ 4"	q	*3225	*3187	*3166	*3153	*3122	2294	1756	1387	1124
		F	0.9+60R	2.2+40R	2.8+30R	3.2+24R	3.5+20R	3.6+17R	3.8+15R	3.9+13R	4+12R
16	VSC2 @ 24"	q	2081	1809	1665	1576	1516	1472	1439	1414	1393
		F	6.3+33R	7.7+22R	8.4+16R	8.8+13R	9.2+11R	9.4+9R	9.6+8R	9.7+7R	9.8+6R
	VSC2 @ 18"	q	2508	2126	2148	1977	1858	1911	1829	1763	1568
		F	4.8+34R	6.3+22R	6.3+17R	7+13R	7.5+11R	7.3+9R	7.6+8R	7.9+7R	7.7+7R
	VSC2 @ 12"	q	2869	2671	2565	2499	2453	2420	2396	1936	1568
		F	3.8+34R	4.7+23R	5.2+17R	5.5+14R	5.7+11R	5.8+10R	5.9+8R	6+7R	6.1+7R
	VSC2 @ 8"	q	*3420	*3283	*3210	*3163	*3132	*3109	2450	1936	1568
		F	2.8+34R	3.6+23R	4+17R	4.3+14R	4.4+11R	4.5+10R	4.6+9R	4.7+8R	4.8+7R
	VSC2 @ 6"	q	*3797	*3704	*3653	*3622	*3600	*3200	2450	1936	1568
		F	2.2+34R	3+23R	3.4+17R	3.6+14R	3.8+11R	3.9+10R	4+9R	4+8R	4.1+7R
	VSC2 @ 4"	q	*4240	*4194	*4170	*4154	*4144	*3200	2450	1936	1568
		F	1.6+34R	2.4+23R	2.7+17R	3+14R	3.1+11R	3.2+10R	3.3+9R	3.4+8R	3.4+7R

1. For diaphragm shear strengths in bold and marked with *, the fastening pattern shall be increased at the building perimeter, chords, collectors to other shear transfer elements to two fasteners per rib (i.e. 24/8 pattern) or shall be limited to 1300 plf, 1700 plf, 2300 plf or 3100 plf for 22, 20, 18 or 16 gage steel deck, respectively. Bearing at supports shall allow for proper end distance and fastener spacing.
2. See footnotes on page 106.

Type PLN™ -24

- 24/4 Screw Pattern at Supports
#12 or #14 SDI Recognized Screws
to Supports 0.0385" and thicker
- Sidelaps Connected with PunchLok II Tool



Allowable Diaphragm Shear Strength, q (plf) and Flexibility Factors, F ((in./lb)x10⁶)

DECK GAGE	SIDELAP ATTACHMENT	SPAN (ft.-in.)									
		2'-0"	4'-0"	6'-0"	8'-0"	10'-0"	12'-0"	14'-0"	16'-0"	18'-0"	
22	VSC2 @ 24"	q	627	537	492	469	454	444	437	432	428
		F	-11.3+387R	5.2+191R	12+125R	16+93R	18.7+74R	20.6+61R	22.1+52R	23.2+45R	24.1+40R
	VSC2 @ 18"	q	812	663	586	609	572	545	565	546	531
		F	-12.9+388R	3+192R	9.7+126R	12+95R	14.8+75R	16.9+62R	17.1+53R	18.5+46R	19.6+41R
	VSC2 @ 12"	q	812	759	733	718	710	704	699	696	690
		F	-12.9+388R	1.5+193R	6.8+128R	9.6+95R	11.3+76R	12.5+63R	13.3+54R	14+47R	14.5+42R
	VSC2 @ 8"	q	917	887	872	864	859	855	853	851	690
		F	-14+388R	-0.5+193R	4.2+129R	6.6+96R	8.1+77R	9.1+64R	9.8+55R	10.4+48R	10.8+43R
	VSC2 @ 6"	q	980	962	953	948	945	943	942	873	690
		F	-14.8+389R	-1.7+194R	2.7+129R	5+97R	6.3+77R	7.2+64R	7.9+55R	8.4+48R	8.8+43R
	VSC2 @ 4"	q	1044	1036	1032	1031	1029	1029	1028	873	690
		F	-15.8+389R	-3.2+194R	1+129R	3.1+97R	4.4+78R	5.3+65R	5.9+55R	6.3+49R	6.7+43R
20	VSC2 @ 24"	q	797	698	648	621	605	594	586	580	575
		F	-4.5+244R	6.5+120R	11+79R	13.6+59R	15.3+46R	16.6+38R	17.5+33R	18.2+28R	18.8+25R
	VSC2 @ 18"	q	1023	856	767	799	754	723	749	726	707
		F	-6.1+245R	4.5+121R	9+80R	10.3+60R	12.2+47R	13.6+39R	13.6+34R	14.5+29R	15.2+26R
	VSC2 @ 12"	q	1023	971	944	929	921	915	910	907	904
		F	-6.1+245R	3.2+122R	6.5+81R	8.3+60R	9.4+48R	10.1+40R	10.7+34R	11.1+30R	11.4+27R
	VSC2 @ 8"	q	1142	1114	1100	1092	1088	1085	1082	1081	906
		F	-7.1+246R	1.5+122R	4.5+81R	6+61R	6.9+49R	7.5+41R	8+35R	8.3+30R	8.6+27R
	VSC2 @ 6"	q	1209	1193	1185	1180	1178	1176	1175	1146	906
		F	-7.7+246R	0.5+123R	3.3+82R	4.7+61R	5.6+49R	6.2+41R	6.6+35R	6.9+31R	7.1+27R
	VSC2 @ 4"	q	1273	1267	1264	1262	1261	1260	1260	1146	906
		F	-8.6+246R	-0.6+123R	2+82R	3.4+61R	4.2+49R	4.7+41R	5.1+35R	5.4+31R	5.6+27R
18	VSC2 @ 24"	q	1127	1008	948	916	896	883	873	866	860
		F	0.3+119R	5.7+59R	7.9+39R	9+29R	9.8+23R	10.3+19R	10.7+16R	10.9+14R	11.2+13R
	VSC2 @ 18"	q	1428	1224	1113	1160	1103	1062	1099	1068	1044
		F	-1.2+120R	4.2+59R	6.5+39R	6.8+29R	7.8+23R	8.4+19R	8.3+17R	8.8+15R	9.1+13R
	VSC2 @ 12"	q	1428	1372	1343	1328	1319	1312	1307	1304	1301
		F	-1.2+120R	3.3+60R	4.8+40R	5.6+30R	6.1+24R	6.4+20R	6.7+17R	6.8+15R	7+13R
	VSC2 @ 8"	q	1572	1544	1531	1523	1519	1515	1513	1512	1387
		F	-1.9+120R	2.2+60R	3.6+40R	4.3+30R	4.7+24R	5+20R	5.2+17R	5.3+15R	5.5+13R
	VSC2 @ 6"	q	1648	1633	1625	1621	1619	1617	1616	1615	1387
		F	-2.4+120R	1.6+60R	2.9+40R	3.6+30R	4+24R	4.2+20R	4.4+17R	4.6+15R	4.7+13R
	VSC2 @ 4"	q	1718	1712	1709	1708	1707	1706	1706	1706	1387
		F	-2.9+120R	0.9+60R	2.2+40R	2.8+30R	3.2+24R	3.5+20R	3.6+17R	3.8+15R	3.9+13R
16	VSC2 @ 24"	q	1456	1317	1246	1208	1185	1169	1158	1149	1142
		F	2.2+68R	5.8+33R	7.2+22R	8+16R	8.5+13R	8.9+11R	9.1+9R	9.3+8R	9.5+7R
	VSC2 @ 18"	q	1828	1587	1455	1515	1446	1396	1442	1405	1375
		F	0.9+68R	4.5+34R	6+22R	6.2+17R	6.8+13R	7.3+11R	7.2+9R	7.5+8R	7.8+7R
	VSC2 @ 12"	q	1828	1767	1735	1719	1708	1701	1696	1692	1689
		F	0.9+68R	3.7+34R	4.6+23R	5.1+17R	5.4+13R	5.6+11R	5.7+10R	5.9+8R	5.9+7R
	VSC2 @ 8"	q	1998	1968	1954	1946	1941	1938	1936	1934	1933
		F	0.3+68R	2.7+34R	3.5+23R	4+17R	4.2+14R	4.4+11R	4.5+10R	4.6+9R	4.7+8R
	VSC2 @ 6"	q	2084	2068	2061	2057	2054	2052	2051	2050	1936
		F	-0.1+69R	2.2+34R	3+23R	3.4+17R	3.6+14R	3.8+11R	3.9+10R	4+9R	4+8R
	VSC2 @ 4"	q	2162	2156	2153	2152	2151	2150	2150	2150	1936
		F	-0.6+69R	1.6+34R	2.4+23R	2.7+17R	3+14R	3.1+11R	3.2+10R	3.3+9R	3.4+8R

See footnotes on page 106.

Type PLN™ -24

- 24/6 Screw Pattern at Supports
#12 or #14 SDI Recognized Screws
to Supports 0.0385" and thicker
- Sidelaps Connected with PunchLok II Tool

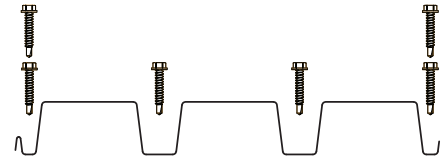

Allowable Diaphragm Shear Strength, q (plf) and Flexibility Factors, F ((in./lb)x10⁶)

DECK GAGE	SIDELAP ATTACHMENT	SPAN (ft-in.)									
		2'-0"	4'-0"	6'-0"	8'-0"	10'-0"	12'-0"	14'-0"	16'-0"	18'-0"	
22	VSC2 @ 24"	q	895	710	616	567	536	515	500	489	480
		F	-14+387R	1.5+192R	8.1+126R	12.1+93R	14.9+73R	17+60R	18.6+51R	19.9+44R	21+39R
	VSC2 @ 18"	q	*1110	856	724	731	672	631	649	621	599
		F	-14.7+388R	0.4+192R	6.8+127R	9.6+94R	12.4+75R	14.4+62R	15.1+53R	16.4+46R	17.6+40R
	VSC2 @ 12"	q	*1110	979	910	873	850	834	823	814	690
		F	-14.7+388R	-0.5+193R	5+128R	7.9+95R	9.8+76R	11.2+63R	12.1+54R	12.9+47R	13.5+42R
	VSC2 @ 8"	q	*1258	*1168	*1120	1094	1078	1067	1059	873	690
		F	-15.3+388R	-1.7+193R	3.2+128R	5.7+96R	7.3+77R	8.4+64R	9.2+55R	9.8+48R	10.3+42R
	VSC2 @ 6"	q	*1361	*1299	*1266	*1248	*1237	*1229	*1140	873	690
		F	-15.7+389R	-2.6+194R	2+129R	4.4+96R	5.9+77R	6.8+64R	7.5+55R	8.1+48R	8.5+43R
	VSC2 @ 4"	q	*1484	*1453	*1436	*1428	*1422	*1418	*1140	873	690
		F	-16.4+389R	-3.7+194R	0.7+129R	2.9+97R	4.2+77R	5.1+65R	5.7+55R	6.2+48R	6.6+43R
20	VSC2 @ 24"	q	1122	912	804	746	711	687	669	656	646
		F	-6.7+245R	3.7+121R	8.2+79R	10.9+58R	12.8+46R	14.2+38R	15.3+32R	16.1+28R	16.8+24R
	VSC2 @ 18"	q	*1397	1101	946	963	891	841	867	832	804
		F	-7.5+245R	2.6+121R	7+80R	8.7+60R	10.6+47R	12+39R	12.3+33R	13.2+29R	14+25R
	VSC2 @ 12"	q	*1397	1257	1184	1144	1119	1102	1090	1080	906
		F	-7.5+245R	1.8+122R	5.4+81R	7.3+60R	8.5+48R	9.3+40R	9.9+34R	10.4+30R	10.8+26R
	VSC2 @ 8"	q	*1576	*1485	*1437	*1411	*1395	*1384	*1376	1146	906
		F	-8+246R	0.7+122R	3.8+81R	5.5+61R	6.5+49R	7.1+40R	7.6+35R	8+30R	8.3+27R
	VSC2 @ 6"	q	*1693	*1633	*1602	*1585	*1574	*1567	*1497	1146	906
		F	-8.4+246R	0+123R	2.9+82R	4.4+61R	5.3+49R	5.9+41R	6.4+35R	6.7+30R	6.9+27R
	VSC2 @ 4"	q	*1826	*1798	*1783	*1775	*1771	*1767	*1497	1146	906
		F	-9+246R	-0.9+123R	1.8+82R	3.2+61R	4+49R	4.6+41R	5+35R	5.3+31R	5.5+27R
18	VSC2 @ 24"	q	1568	1306	1170	1098	1053	1023	1001	984	971
		F	-1+119R	4.4+59R	6.6+39R	7.9+29R	8.8+23R	9.4+19R	9.8+16R	10.2+14R	10.5+12R
	VSC2 @ 18"	q	*1953	1578	1377	1412	1316	1248	1289	1241	1203
		F	-1.8+120R	3.4+59R	5.6+39R	6.2+29R	7.2+23R	7.9+19R	7.9+16R	8.3+14R	8.7+13R
	VSC2 @ 12"	q	*1953	1793	1708	1662	1633	1614	1599	1589	1387
		F	-1.8+120R	2.7+59R	4.4+39R	5.2+30R	5.8+24R	6.1+20R	6.4+17R	6.6+15R	6.8+13R
	VSC2 @ 8"	q	*2186	*2089	*2038	*2010	*1993	*1981	*1972	1756	1387
		F	-2.3+120R	1.9+60R	3.3+40R	4.1+30R	4.5+24R	4.8+20R	5.1+17R	5.2+15R	5.4+13R
	VSC2 @ 6"	q	*2330	*2269	*2237	*2221	*2210	*2203	*2197	1756	1387
		F	-2.7+120R	1.4+60R	2.8+40R	3.4+30R	3.9+24R	4.1+20R	4.4+17R	4.5+15R	4.6+13R
	VSC2 @ 4"	q	*2484	*2457	*2444	*2436	*2432	*2429	*2294	1756	1387
		F	-3.1+120R	0.8+60R	2.1+40R	2.8+30R	3.2+24R	3.4+20R	3.6+17R	3.7+15R	3.9+13R
16	VSC2 @ 24"	q	2015	1700	1536	1449	1395	1358	1331	1311	1295
		F	1.1+68R	4.6+33R	6.2+22R	7.1+16R	7.7+13R	8.2+10R	8.5+9R	8.7+8R	8.9+7R
	VSC2 @ 18"	q	*2506	2052	1806	1857	1738	1653	1707	1647	1599
		F	0.4+68R	3.8+34R	5.3+22R	5.7+16R	6.3+13R	6.9+11R	6.8+9R	7.2+8R	7.4+7R
	VSC2 @ 12"	q	*2506	*2323	*2226	2173	2140	2118	2101	2089	1936
		F	0.4+68R	3.2+34R	4.2+22R	4.8+17R	5.1+13R	5.4+11R	5.6+9R	5.7+8R	5.8+7R
	VSC2 @ 8"	q	*2791	*2684	*2628	*2598	*2579	*2566	*2556	*2450	1936
		F	-0.1+68R	2.5+34R	3.4+23R	3.8+17R	4.1+14R	4.3+11R	4.4+10R	4.5+8R	4.6+8R
	VSC2 @ 6"	q	*2961	*2896	*2863	*2845	*2833	*2826	*2820	*2450	1936
		F	-0.4+69R	2+34R	2.9+23R	3.3+17R	3.5+14R	3.7+11R	3.8+10R	3.9+9R	4+8R
	VSC2 @ 4"	q	*3139	*3111	*3097	*3090	*3085	*3082	*3080	*2450	1936
		F	-0.7+69R	1.5+34R	2.3+23R	2.7+17R	2.9+14R	3.1+11R	3.2+10R	3.3+9R	3.3+8R

1. For diaphragm shear strengths in bold and marked with *, the fastening pattern shall be increased at the building perimeter, chords, collectors to other shear transfer elements to two fasteners per rib (i.e. 24/8 pattern) or shall be limited to 1100 plf, 1300 plf, 1800 plf or 2200 plf for 22, 20, 18 or 16 gage steel deck, respectively. Bearing at supports shall allow for proper end distance and fastener spacing.

2. See footnotes on page 106.

Type N-24

- 24/4 Weld Pattern at Supports
- Sidelaps Connected with Button Punch or 1½" Top Seam Weld

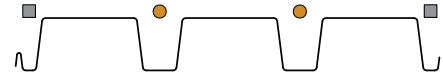

Allowable Diaphragm Shear Strength, q (plf) and Flexibility Factors, F ((in./lb)x10⁶)

DECK GAGE	SIDELAP ATTACHMENT	SPAN (ft.-in.)									
		4'-0"	6'-0"	8'-0"	10'-0"	12'-0"	14'-0"	16'-0"	18'-0"	20'-0"	
22	BP @ 24"	q	245	174	139	119	105	95	88	82	77
		F	10+187R	21.4+119R	30.1+84R	37.4+62R	43.9+48R	49.7+37R	55+28R	59.8+22R	64.3+16R
	BP @ 12"	q	281	210	175	154	141	131	123	118	113
		F	8.5+188R	18.4+121R	25.5+87R	31+67R	35.6+53R	39.4+43R	42.8+35R	45.7+30R	48.3+25R
	TSW @ 24"	q	644	572	538	517	503	494	486	480	474
		F	-2.2+194R	2.2+129R	4.5+97R	5.9+77R	6.8+64R	7.4+55R	7.9+48R	8.3+43R	8.6+39R
	TSW @ 18"	q	837	710	732	674	635	659	631	609	559
		F	-3.5+194R	1.1+129R	2.8+97R	4.4+78R	5.4+65R	5.7+55R	6.4+48R	6.9+43R	6.9+39R
	TSW @ 12"	q	990	930	898	879	865	856	849	690	559
		F	-4.3+194R	-0.2+130R	1.9+97R	3.2+78R	4+65R	4.6+56R	5+49R	5.4+43R	5.6+39R
	TSW @ 6"	q	1422	1389	1371	1361	1353	1140	873	690	559
		F	-5.6+195R	-1.5+130R	0.5+97R	1.7+78R	2.5+65R	3.1+56R	3.5+49R	3.8+43R	4.1+39R
20	BP @ 24"	q	360	251	201	171	151	137	126	118	112
		F	12.1+116R	21.3+73R	28.7+50R	35.1+35R	40.8+25R	45.9+18R	50.6+12R	54.9+8R	58.9+4R
	BP @ 12"	q	412	303	253	223	203	189	178	170	163
		F	10.7+117R	18.7+74R	24.5+52R	29.2+39R	33.2+30R	36.6+24R	39.5+19R	42.1+15R	44.4+12R
	TSW @ 24"	q	863	754	704	674	654	640	628	619	611
		F	1+122R	3.9+82R	5.4+61R	6.3+49R	6.9+41R	7.3+35R	7.7+30R	7.9+27R	8.1+24R
	TSW @ 18"	q	1092	923	947	871	819	849	812	783	734
		F	-0.3+123R	2.8+82R	3.9+61R	4.9+49R	5.7+41R	5.8+35R	6.3+31R	6.6+27R	6.6+24R
	TSW @ 12"	q	1286	1202	1158	1131	1112	1099	1089	906	734
		F	-1+123R	1.7+82R	3+61R	3.8+49R	4.4+41R	4.7+35R	5+31R	5.3+27R	5.4+25R
	TSW @ 6"	q	1829	1783	1759	1744	1734	1497	1146	906	734
		F	-2.1+123R	0.4+82R	1.7+62R	2.5+49R	3+41R	3.4+35R	3.6+31R	3.8+27R	4+25R
18	BP @ 24"	q	650	447	358	305	269	244	225	210	198
		F	12.9+54R	19.9+32R	25.9+20R	31.1+12R	35.8+6R	40.2+2R	44.1-1R	47.8-4R	51.2-6R
	BP @ 12"	q	741	539	450	396	361	335	316	301	290
		F	11.7+55R	17.6+33R	22.2+22R	26+15R	29.2+10R	32+7R	34.5+5R	36.6+3R	38.6+1R
	TSW @ 24"	q	1354	1167	1078	1024	988	961	940	924	911
		F	3.2+60R	4.8+40R	5.6+30R	6.1+24R	6.5+20R	6.7+17R	6.9+15R	7+13R	7.1+12R
	TSW @ 18"	q	1670	1402	1426	1307	1226	1266	1210	1165	1124
		F	2.2+60R	3.9+40R	4.3+30R	4.9+24R	5.4+20R	5.4+17R	5.7+15R	5.9+13R	5.8+12R
	TSW @ 12"	q	1949	1808	1733	1688	1657	1634	1617	1387	1124
		F	1.6+60R	2.9+40R	3.6+30R	4+24R	4.3+20R	4.5+17R	4.6+15R	4.7+13R	4.8+12R
	TSW @ 6"	q	2738	2661	2620	2594	2576	2294	1756	1387	1124
		F	0.5+60R	1.8+40R	2.4+30R	2.8+24R	3.1+20R	3.3+17R	3.4+15R	3.5+13R	3.6+12R
16	BP @ 24"	q	848	586	475	409	364	333	309	291	276
		F	12.4+29R	18.3+15R	23.4+8R	28+3R	32.2-1R	36-4R	39.5-6R	42.7-8R	45.7-9R
	BP @ 12"	q	991	729	618	552	507	476	452	434	419
		F	11.4+30R	16.2+17R	20.2+10R	23.4+6R	26.2+3R	28.7+1R	30.8-1R	32.7-2R	34.4-3R
	TSW @ 24"	q	1758	1535	1423	1354	1307	1273	1247	1227	1211
		F	3.8+34R	4.8+22R	5.3+17R	5.7+13R	5.9+11R	6+10R	6.2+8R	6.3+7R	6.3+7R
	TSW @ 18"	q	2175	1838	1877	1726	1622	1677	1605	1548	1568
		F	2.8+34R	4+23R	4.2+17R	4.6+14R	4.9+11R	4.9+10R	5.1+8R	5.2+7R	5.2+7R
	TSW @ 12"	q	2540	2370	2280	2225	2188	2161	2140	1936	1568
		F	2.3+34R	3.1+23R	3.5+17R	3.8+14R	3.9+11R	4+10R	4.1+9R	4.2+8R	4.2+7R
	TSW @ 6"	q	3543	3454	3407	3378	3358	3200	2450	1936	1568
		F	1.4+34R	2.1+23R	2.5+17R	2.7+14R	2.9+11R	3+10R	3+9R	3.1+8R	3.2+7R

See footnotes on page 106.

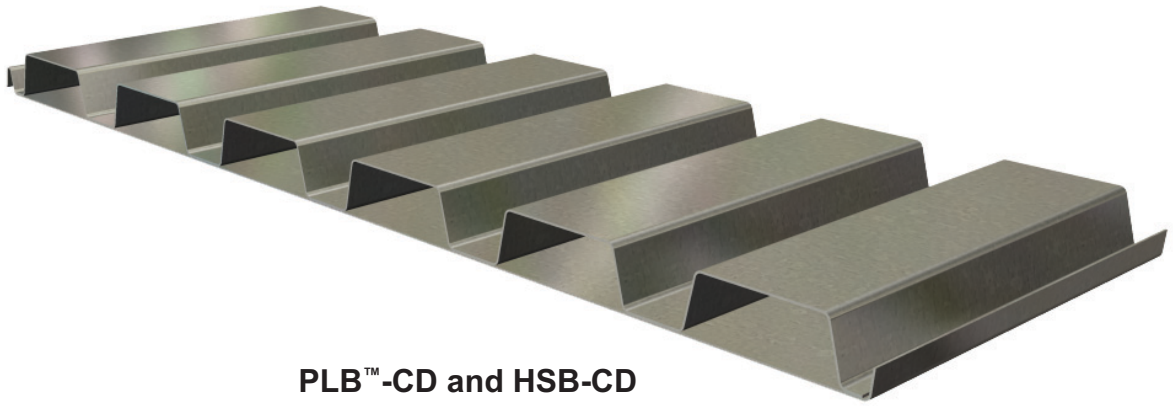

PLB™-CD and HSB-CD
(Acoustic Version Available)

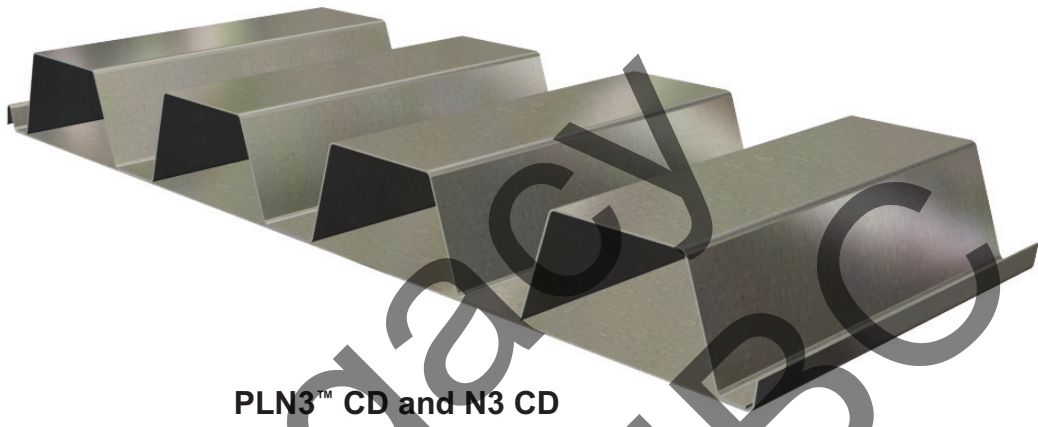

PLN3™ CD and N3 CD
(Acoustic Version Available)

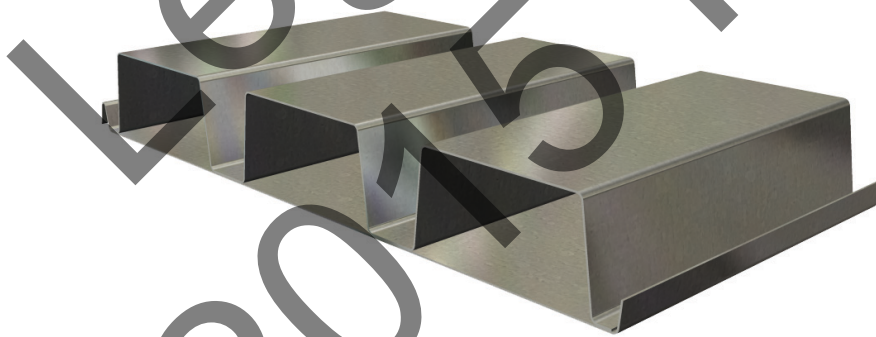

PLN™-24 CD and N-24 CD
(Acoustic Version Available)

CELLULAR ROOF DECK CONTENTS

Section Properties	125-127
Vertical Load Capacity	128-136
PLB™-36 CD Allowable Diaphragm Shear Strength and Flexibility Tables	137-138
PLN3™ CD Allowable Diaphragm Shear Strength and Flexibility Tables	139-140
PLN™-24 CD Allowable Diaphragm Shear Strength and Flexibility Tables	141-142
Acoustical Properties	155

PLB™-CD or HSB®-CD

- 1½" Deep Cellular Roof Deck
- Galvanized
- PLB-CD used with PunchLok II System
- HSB-CD used with Top Seam Welds

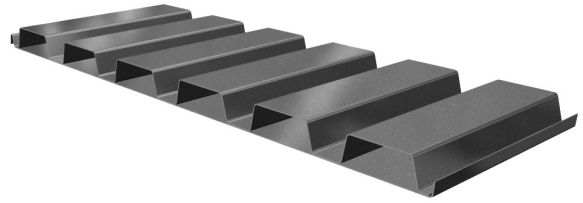

Dimensions

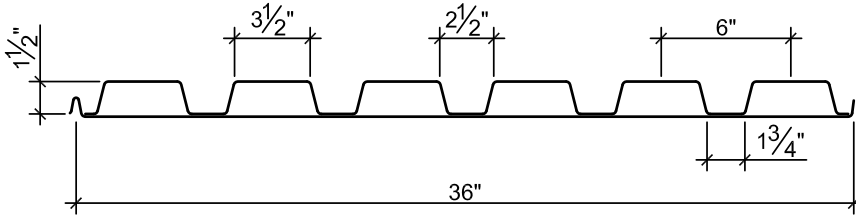

PLB-CD, PLB-CD AC,
HSB-CD or HSB-CD AC

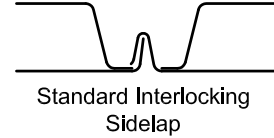

Deck Weight and Section Properties

Gage	Weight (psf)	I_d for Deflections		Positive Moment		Negative Moment		Vertical Shear	
		Single Span (in. ⁴)	Multiple Spans (in. ⁴)	+ S_{eff} (in. ³)	+M (in.-kips)	- S_{eff} (in. ³)	-M (in.-kips)	End (lb)	Interior (lb)
20/20	3.6	0.416	0.416	0.279	8.4	0.382	11.4	340	510
20/18	4.1	0.454	0.454	0.287	8.6	0.428	12.8	318	369
18/20	4.1	0.535	0.535	0.417	12.5	0.453	13.6	369	612
18/18	4.6	0.587	0.587	0.428	12.8	0.552	16.5	517	667
18/16	5.1	0.631	0.631	0.437	13.1	0.575	17.2	491	524
16/18	5.3	0.704	0.704	0.587	17.6	0.629	18.8	549	757
16/16	5.8	0.759	0.759	0.599	17.9	0.700	20.9	718	821

Notes:

1. Section properties are based on $F_y = 50,000$ psi.
2. Section properties have been computed in accordance with AISI's "S100: Specification for the Design of Cold-Formed Steel Structural Members."
3. The gage "xx/yy" of cellular decks is defined as: First Number (xx) is the gage of the fluted top section. Second Number (yy) is the gage of the flat bottom section.
4. I_d is the effective moment of inertia for deflection of simple or multiple span conditions due to uniform loads.
5. S_{eff} (+ or -) is the effective section modulus. M (+ or -) is the ASD allowable moment, $M = M_n/\Omega_b$, where $\Omega_b = 1.67$ and M_n is the nominal flexural strength. Nominal moments may be determined by multiplying the table values by Ω_b . LRFD moments may be determined by multiplying nominal moments by $\Phi_b = 0.95$.
6. Vertical Shear is the ASD allowable vertical shear strength based on the horizontal shear strength of the resistance welds, where $V = V_n/\Omega$, with $\Omega = 2.35$. "END" shear strength values are applicable adjacent to supports where deck is not continuous and "INTERIOR" shear strength values are applicable adjacent to supports where deck is continuous.
7. End and interior reactions shall be compared to the allowable reactions due to web crippling for fluted (non-cellular) deck of the same gage as the fluted top section of the cellular deck.
8. Multiply tabulated cellular deck values by the following factors to obtain acoustical cellular deck section properties:

Deck Type	I_d for Deflection		Allowable Moment		Vertical Shear	
	Single Span	Multi Span	Positive	Negative	End	Interior
BCD Acoustical	0.97	0.97	0.99	1.00	1.00	1.00

Attachment Patterns to Supports

36/7



- Note:** ● indicates location of arc spot weld, power actuated fastener, or screw as indicated in the load tables.
■ indicates location of arc seam weld, power actuated fastener, or screw as indicated in the load tables.

PLN3™-CD or HSN3™-CD

- 3" Deep Cellular Roof Deck
- Galvanized
- PLN3-CD used with PunchLok II System
- HSN3-CD used with Top Seam Welds

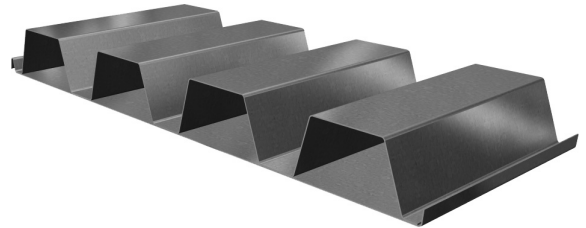

Dimensions

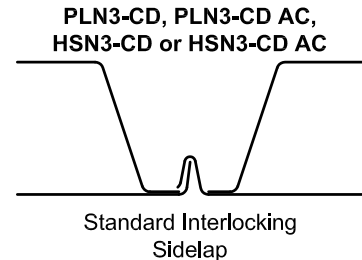
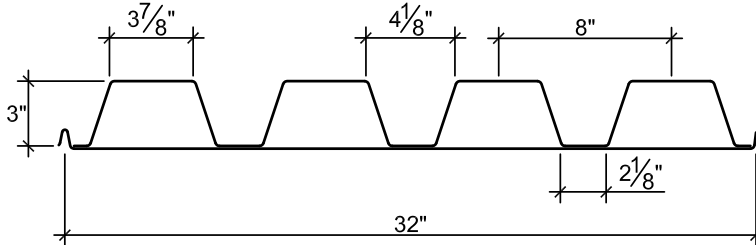

Deck Weight and Section Properties

Gage	Weight (psf)	I_d for Deflections		Positive Moment		Negative Moment		Vertical Shear	
		Single Span (in. ⁴)	Multiple Spans (in. ⁴)	+ S_{eff} (in. ³)	+M (in.-kips)	- S_{eff} (in. ³)	-M (in.-kips)	End (lb)	Interior (lb)
20/20	3.9	1.579	1.579	0.505	15.1	0.709	21.2	528	1,186
20/18	4.4	1.716	1.716	0.503	15.1	0.801	24.0	489	747
18/20	4.6	2.017	2.017	0.804	24.1	0.869	26.0	579	1,438
18/18	5.1	2.194	2.194	0.824	24.7	1.030	30.8	803	1,426
18/16	5.7	2.346	2.346	0.829	24.8	1.077	32.2	756	1,106
16/18	5.9	2.652	2.652	1.107	33.1	1.210	36.2	862	1,684
16/16	6.4	2.838	2.838	1.129	33.8	1.314	39.3	1,115	1,734

Notes:

- Section properties are based on $F_y = 50,000$ psi.
- Section properties have been computed in accordance with AISI's "S100: Specification for the Design of Cold-Formed Steel Structural Members."
- The gage "xx/yy" of cellular decks is defined as: First Number (xx) is the gage of the fluted top section. Second Number (yy) is the gage of the flat bottom section.
- I_d is the effective moment of inertia for deflection of simple or multiple span conditions due to uniform loads.
- S_{eff} (+ or -) is the effective section modulus. M (+ or -) is the ASD allowable moment, $M = M_n/\Omega_b$, where $\Omega_b = 1.67$ and M_n is the nominal flexural strength. Nominal moments may be determined by multiplying the table values by Ω_b . LRFD moments may be determined by multiplying nominal moments by $\Phi_b = 0.95$.
- Vertical Shear is the ASD allowable vertical shear strength based on the horizontal shear strength of the resistance welds, where $V = V_n/\Omega$, with $\Omega = 2.35$. "END" shear strength values are applicable adjacent to supports where deck is not continuous and "INTERIOR" shear strength values are applicable adjacent to supports where deck is continuous.
- End and interior reactions shall be compared to the allowable reactions due to web crippling for fluted (non-cellular) deck of the same gage as the fluted top section of the cellular deck.
- Multiply tabulated cellular deck values by the following factors to obtain acoustical cellular deck section properties:

Deck Type	I_d for Deflection		Allowable Moment		Vertical Shear	
	Single Span	Multi Span	Positive	Negative	End	Interior
N3CD Acoustical	0.97	0.99	0.99	1.00	1.00	1.00

Attachment Patterns to Supports



- Note:** ● indicates location of arc spot weld, power actuated fastener, or screw as indicated in the load tables.
 ■ indicates location of arc seam weld, power actuated fastener, or screw as indicated in the load tables.

PLN™-24-CD or N-24-CD

- 1½" Deep Cellular Roof Deck
- Galvanized
- PLN-24-CD used with PunchLok II System
- N-24-CD used with Top Seam Welds



Dimensions

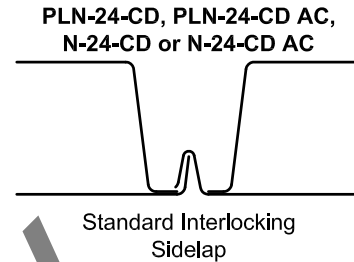
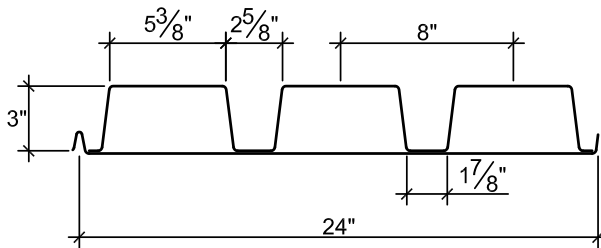

Deck Weight and Section Properties

Gage	Weight (psf)	I_d for Deflections		Positive Moment		Negative Moment		Vertical Shear	
		Single Span (in. ⁴)	Multiple Spans (in. ⁴)	+ S_{eff} (in. ³)	+M (in.-kips)	- S_{eff} (in. ³)	-M (in.-kips)	End (lb)	Interior (lb)
20/20	4.1	1.681	1.681	0.518	15.5	0.706	21.2	559	1039
20/18	4.6	1.841	1.841	0.515	15.4	0.909	27.2	522	718
18/20	4.8	2.159	2.159	0.805	24.1	0.852	25.5	608	1,253
18/18	5.3	2.369	2.369	0.826	24.7	1.055	31.6	850	1,275
18/16	5.8	2.544	2.544	0.843	25.2	1.318	39.5	805	966
16/18	6.1	2.881	2.881	1.121	33.6	1.199	35.9	906	1,455
16/16	6.6	3.106	3.106	1.144	34.3	1.475	44.2	1,181	1,498

Notes:

1. Section properties are based on $F_y = 50,000$ psi.
2. Section properties have been computed in accordance with AISI's "S100: Specification for the Design of Cold-Formed Steel Structural Members."
3. The gage "xx/yy" of cellular decks is defined as: First Number (xx) is the gage of the fluted top section. Second Number (yy) is the gage of the flat bottom section.
4. I_d is the effective moment of inertia for deflection of simple or multiple span conditions due to uniform loads.
5. S_{eff} (+ or -) is the effective section modulus. M (+ or -) is the ASD allowable moment, $M = M_n/\Omega_b$, where $\Omega_b = 1.67$ and M_n is the nominal flexural strength. Nominal moments may be determined by multiplying the table values by Ω_b . LRFDMoments may be determined by multiplying nominal moments by $\Phi_b = 0.95$.
6. Vertical Shear is the ASD allowable vertical shear strength based on the horizontal shear strength of the resistance welds, where $V = V_n/\Omega$, with $\Omega = 2.35$. "END" shear strength values are applicable adjacent to supports where deck is not continuous and "INTERIOR" shear strength values are applicable adjacent to supports where deck is continuous.
7. End and interior reactions shall be compared to the allowable reactions due to web crippling for fluted (non-cellular) deck of the same gage as the fluted top section of the cellular deck.
8. Multiply tabulated cellular deck values by the following factors to obtain acoustical cellular deck section properties:

Deck Type	I_d for Deflection		Allowable Moment		Vertical Shear	
	Single Span	Multi Span	Positive	Negative	End	Interior
N24CD Acoustical	0.97	0.97	0.99	1.00	1.00	1.00

Attachment Patterns to Supports



- Note:** ● indicates location of arc spot weld, power actuated fastener, or screw as indicated in the load tables.
 ■ indicates location of arc seam weld, power actuated fastener, or screw as indicated in the load tables.

Footnotes for Allowable Uniform Load Tables

1. Stress = Allowable uniform load based on maximum allowable flexural stress in deck.
2. Shear = Allowable uniform load governed by vertical shear strength based on horizontal shear strength of the resistance welds.
3. L/360, L/240 or L/180 = Uniform load which produces selected deflection in deck.
4. The symbol ♦♦ indicates allowable uniform load based on deflection exceeds allowable uniform load based on stress or shear.
5. Nominal uniform loads based on flexural stress may be determined by multiplying the allowable values in the table by $\Omega_b = 1.67$. LRFD loads may be determined by multiplying nominal loads by $\Phi_b = 0.95$.
6. Nominal uniform loads based on vertical shear may be determined by multiplying the allowable values in the table by $\Omega_b = 2.35$. LRFD loads may be determined by multiplying nominal loads by $\Phi_b = 0.65$.

Footnotes for Diaphragm Shear Strength and Flexibility Factor Tables

General Notes

1. VSC2 = Verco Sidlap Connection 2
2. The dimension from the first and last sidlap connection within each span is to be no more than one-half of specified spacing.
3. R is the ratio of vertical span (L_V) of the deck to the length (L_S) of the deck sheet: $R = L_V / L_S$.
4. Interpolation of diaphragm shear strength between adjacent spans or sidlap spacings is permissible. For interpolation of the diaphragm flexibility factor between adjacent spans, use the flexibility factor for the closest adjacent span length.
5. Diaphragm shear values for side seam fasteners placed at spacings other than those in the table should be determined based on the number of fasteners in each span.
6. For acoustical deck profiles, modify tabulated q and F values using the following adjustment factors:

Deck Type	R_q	R_F
BCD - Acoustical	0.98	1.09
N3CD - Acoustical	0.98	1.11
N24CD - Acoustical	0.97	1.10

- Note:** Adjustment Factor, R_q must be applied only to allowable diaphragm shear strengths governed by panel buckling which are shown in the shaded areas of the diaphragm tables.
7. The allowable diaphragm shear values in the table utilize a factor of safety, $\Omega = 3.0$ (limited by connections) with the exception of the gray shaded table values, which utilize a factor of safety of $\Omega = 2.0$ (limited by panel buckling).
 8. A 1" x 3/8" effective arc seam weld is required at supports adjacent to sidlap and 1/2" effective diameter arc spot welds are required at supports in interior flutes.
 9. Diaphragm shear strength and flexibility factors for fluted decks attached at the sidlap with either VSC2 or Top-Seam Welds may be applicable to cellular sections with a fluted top section of the same profile but with the gage of the flat bottom sheet. This applies with or without acoustical perforations in the flat bottom section of the cellular deck.

Type PLB™ -CD or HSB®-CD

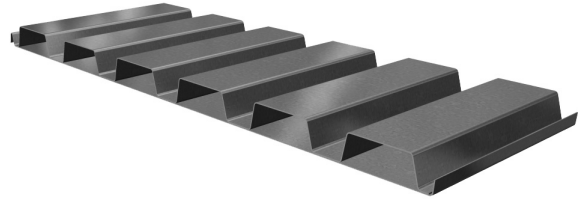

Allowable Uniform Loads (psf)

SINGLE	DECK		SPAN (ft-in.)																	
	SPAN	GAGE	CRITERIA	2'-0"	3'-0"	4'-0"	5'-0"	5'-6"	6'-0"	6'-6"	7'-0"	7'-6"	8'-0"	8'-6"	9'-0"	9'-6"	10'-0"	11'-0"	12'-0"	
20/20		Stress		300	300	300	223	184	155	132	114	99	87	77	69	62	56	46	39	
		Shear		300	227	170	136	124	113	105	97	91	85	80	76	72	68	62	57	
		L/360	◆◆◆	◆◆◆	◆◆◆	◆◆◆	◆◆◆	◆◆◆	◆◆◆	◆◆◆	◆◆◆	◆◆◆	◆◆◆	◆◆◆	◆◆◆	◆◆◆	◆◆◆	◆◆◆	◆◆◆	◆◆◆
		L/240	◆◆◆	◆◆◆	◆◆◆	◆◆◆	◆◆◆	◆◆◆	◆◆◆	◆◆◆	◆◆◆	◆◆◆	◆◆◆	◆◆◆	◆◆◆	◆◆◆	◆◆◆	◆◆◆	◆◆◆	◆◆◆
		L/180	◆◆◆	◆◆◆	◆◆◆	◆◆◆	◆◆◆	◆◆◆	◆◆◆	◆◆◆	◆◆◆	◆◆◆	◆◆◆	◆◆◆	◆◆◆	◆◆◆	◆◆◆	◆◆◆	◆◆◆	◆◆◆
20/18		Stress		300	300	300	230	190	159	136	117	102	90	79	71	64	57	47	40	
		Shear		300	212	159	127	116	106	98	91	85	80	75	71	67	64	58	53	
		L/360	◆◆◆	◆◆◆	◆◆◆	◆◆◆	◆◆◆	◆◆◆	◆◆◆	◆◆◆	◆◆◆	◆◆◆	◆◆◆	◆◆◆	◆◆◆	◆◆◆	◆◆◆	◆◆◆	◆◆◆	◆◆◆
		L/240	◆◆◆	◆◆◆	◆◆◆	◆◆◆	◆◆◆	◆◆◆	◆◆◆	◆◆◆	◆◆◆	◆◆◆	◆◆◆	◆◆◆	◆◆◆	◆◆◆	◆◆◆	◆◆◆	◆◆◆	◆◆◆
		L/180	◆◆◆	◆◆◆	◆◆◆	◆◆◆	◆◆◆	◆◆◆	◆◆◆	◆◆◆	◆◆◆	◆◆◆	◆◆◆	◆◆◆	◆◆◆	◆◆◆	◆◆◆	◆◆◆	◆◆◆	◆◆◆
18/20		Stress		300	300	300	300	276	232	197	170	148	130	115	103	92	83	69	58	
		Shear		300	246	184	147	134	123	113	105	98	92	87	82	78	74	67	61	
		L/360	◆◆◆	◆◆◆	◆◆◆	◆◆◆	◆◆◆	◆◆◆	◆◆◆	◆◆◆	◆◆◆	◆◆◆	◆◆◆	◆◆◆	◆◆◆	◆◆◆	◆◆◆	◆◆◆	◆◆◆	◆◆◆
		L/240	◆◆◆	◆◆◆	◆◆◆	◆◆◆	◆◆◆	◆◆◆	◆◆◆	◆◆◆	◆◆◆	◆◆◆	◆◆◆	◆◆◆	◆◆◆	◆◆◆	◆◆◆	◆◆◆	◆◆◆	◆◆◆
		L/180	◆◆◆	◆◆◆	◆◆◆	◆◆◆	◆◆◆	◆◆◆	◆◆◆	◆◆◆	◆◆◆	◆◆◆	◆◆◆	◆◆◆	◆◆◆	◆◆◆	◆◆◆	◆◆◆	◆◆◆	◆◆◆
18/18		Stress		300	300	300	300	283	238	203	175	152	134	118	106	95	86	71	59	
		Shear		300	300	258	207	188	172	159	148	138	129	122	115	109	103	94	86	
		L/360	◆◆◆	◆◆◆	◆◆◆	◆◆◆	◆◆◆	◆◆◆	◆◆◆	◆◆◆	◆◆◆	◆◆◆	◆◆◆	◆◆◆	◆◆◆	◆◆◆	◆◆◆	◆◆◆	◆◆◆	◆◆◆
		L/240	◆◆◆	◆◆◆	◆◆◆	◆◆◆	◆◆◆	◆◆◆	◆◆◆	◆◆◆	◆◆◆	◆◆◆	◆◆◆	◆◆◆	◆◆◆	◆◆◆	◆◆◆	◆◆◆	◆◆◆	◆◆◆
		L/180	◆◆◆	◆◆◆	◆◆◆	◆◆◆	◆◆◆	◆◆◆	◆◆◆	◆◆◆	◆◆◆	◆◆◆	◆◆◆	◆◆◆	◆◆◆	◆◆◆	◆◆◆	◆◆◆	◆◆◆	◆◆◆
18/16		Stress		300	300	300	300	289	243	207	178	155	137	121	108	97	87	72	61	
		Shear		300	300	245	196	179	164	151	140	131	123	116	109	103	98	89	82	
		L/360	◆◆◆	◆◆◆	◆◆◆	◆◆◆	◆◆◆	◆◆◆	◆◆◆	◆◆◆	◆◆◆	◆◆◆	◆◆◆	◆◆◆	◆◆◆	◆◆◆	◆◆◆	◆◆◆	◆◆◆	◆◆◆
		L/240	◆◆◆	◆◆◆	◆◆◆	◆◆◆	◆◆◆	◆◆◆	◆◆◆	◆◆◆	◆◆◆	◆◆◆	◆◆◆	◆◆◆	◆◆◆	◆◆◆	◆◆◆	◆◆◆	◆◆◆	◆◆◆
		L/180	◆◆◆	◆◆◆	◆◆◆	◆◆◆	◆◆◆	◆◆◆	◆◆◆	◆◆◆	◆◆◆	◆◆◆	◆◆◆	◆◆◆	◆◆◆	◆◆◆	◆◆◆	◆◆◆	◆◆◆	◆◆◆
16/18		Stress		300	300	300	300	300	300	278	240	209	183	162	145	130	117	97	82	
		Shear		300	300	275	220	200	183	169	157	146	137	129	122	116	110	100	92	
		L/360	◆◆◆	◆◆◆	◆◆◆	◆◆◆	◆◆◆	◆◆◆	◆◆◆	◆◆◆	◆◆◆	◆◆◆	◆◆◆	◆◆◆	◆◆◆	◆◆◆	◆◆◆	◆◆◆	◆◆◆	◆◆◆
		L/240	◆◆◆	◆◆◆	◆◆◆	◆◆◆	◆◆◆	◆◆◆	◆◆◆	◆◆◆	◆◆◆	◆◆◆	◆◆◆	◆◆◆	◆◆◆	◆◆◆	◆◆◆	◆◆◆	◆◆◆	◆◆◆
		L/180	◆◆◆	◆◆◆	◆◆◆	◆◆◆	◆◆◆	◆◆◆	◆◆◆	◆◆◆	◆◆◆	◆◆◆	◆◆◆	◆◆◆	◆◆◆	◆◆◆	◆◆◆	◆◆◆	◆◆◆	◆◆◆
16/16		Stress		300	300	300	300	300	300	284	244	213	187	166	148	133	120	99	83	
		Shear		300	300	300	287	261	239	221	205	191	179	169	159	151	143	130	120	
		L/360	◆◆◆	◆◆◆	◆◆◆	◆◆◆	◆◆◆	◆◆◆	◆◆◆	◆◆◆	◆◆◆	◆◆◆	◆◆◆	◆◆◆	◆◆◆	◆◆◆	◆◆◆	◆◆◆	◆◆◆	◆◆◆
		L/240	◆◆◆	◆◆◆	◆◆◆	◆◆◆	◆◆◆	◆◆◆	◆◆◆	◆◆◆	◆◆◆	◆◆◆	◆◆◆	◆◆◆	◆◆◆	◆◆◆	◆◆◆	◆◆◆	◆◆◆	◆◆◆
		L/180	◆◆◆	◆◆◆	◆◆◆	◆◆◆	◆◆◆	◆◆◆	◆◆◆	◆◆◆	◆◆◆	◆◆◆	◆◆◆	◆◆◆	◆◆◆	◆◆◆	◆◆◆	◆◆◆	◆◆◆	◆◆◆

Notes:
 1. Governing Values are in Bold Font.
 2. See additional footnotes on page 127.

Type PLB™ -CD or HSB® -CD

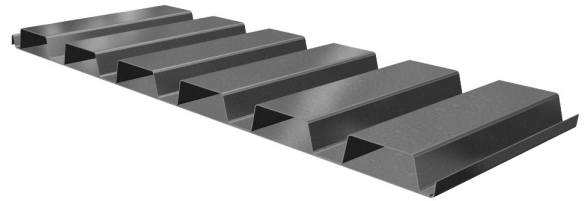

Allowable Uniform Loads (psf)

DECK	SPAN	GAGE	CRITERIA	SPAN (ft.-in.)															
				2'-0"	3'-0"	4'-0"	5'-0"	5'-6"	6'-0"	6'-6"	7'-0"	7'-6"	8'-0"	8'-6"	9'-0"	9'-6"	10'-0"	11'-0"	12'-0"
20/20	DOUBLE	Stress	300	300	300	300	253	212	181	156	136	119	106	94	85	76	63	53	
		Shear	300	273	204	164	149	136	126	117	109	102	96	91	86	82	74	68	
		L/360	***	***	***	***	***	***	***	***	***	104	86	71	60	51	44	33	25
		L/240	***	***	***	***	***	***	***	***	***	***	***	***	90	77	66	49	38
		L/180	***	***	***	***	***	***	***	***	***	***	***	***	***	***	***	***	51
20/18	DOUBLE	Stress	300	300	300	300	283	238	203	175	152	134	119	106	95	86	71	59	
		Shear	295	197	148	118	107	98	91	84	79	74	70	66	62	59	54	49	
		L/360	***	***	***	***	***	***	***	***	***	***	***	***	66	56	48	36	28
		L/240	***	***	***	***	***	***	***	***	***	***	***	***	***	***	***	***	42
		L/180	***	***	***	***	***	***	***	***	***	***	***	***	***	***	***	***	***
18/20	DOUBLE	Stress	300	300	300	300	299	252	214	185	161	142	125	112	100	91	75	63	
		Shear	300	300	245	196	178	163	151	140	131	122	115	109	103	98	89	82	
		L/360	***	***	***	***	***	***	***	***	***	110	92	77	66	56	42	33	
		L/240	***	***	***	***	***	***	***	***	***	***	***	***	99	85	64	49	
		L/180	***	***	***	***	***	***	***	***	***	***	***	***	***	***	***	***	
18/18	DOUBLE	Stress	300	300	300	300	300	300	261	225	196	172	153	136	122	110	91	77	
		Shear	300	300	267	213	194	178	164	152	142	133	126	119	112	107	97	89	
		L/360	***	***	***	***	***	***	***	***	***	121	101	85	72	62	46	36	
		L/240	***	***	***	***	***	***	***	***	***	***	***	***	108	93	70	54	
		L/180	***	***	***	***	***	***	***	***	***	***	***	***	***	***	***	***	
18/16	DOUBLE	Stress	300	300	300	300	300	300	272	235	204	180	159	142	127	115	95	80	
		Shear	300	279	210	168	152	140	129	120	112	105	99	93	88	84	76	70	
		L/360	***	***	***	***	***	***	***	***	***	***	***	***	91	78	66	50	38
		L/240	***	***	***	***	***	***	***	***	***	***	***	***	***	***	***	75	58
		L/180	***	***	***	***	***	***	***	***	***	***	***	***	***	***	***	***	
16/18	DOUBLE	Stress	300	300	300	300	300	300	298	257	224	197	174	155	139	126	104	87	
		Shear	300	300	300	242	220	202	186	173	162	151	143	135	128	121	110	101	
		L/360	***	***	***	***	***	***	***	***	***	145	121	102	87	74	56	43	
		L/240	***	***	***	***	***	***	***	***	***	***	***	***	***	111	84	64	
		L/180	***	***	***	***	***	***	***	***	***	***	***	***	***	***	***	***	
16/16	DOUBLE	Stress	300	300	300	300	300	300	300	286	249	219	194	173	155	140	116	97	
		Shear	300	300	300	262	239	219	202	187	175	164	154	146	138	131	119	109	
		L/360	***	***	***	***	***	***	***	***	***	156	130	110	93	80	60	46	
		L/240	***	***	***	***	***	***	***	***	***	***	***	***	***	120	90	69	
		L/180	***	***	***	***	***	***	***	***	***	***	***	***	***	***	***	***	

Notes:
 1. Governing Values are in Bold Font.
 2. See additional footnotes on page 127.

Type PLB™ -CD or HSB®-CD

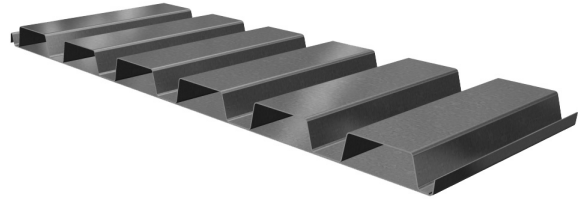

Allowable Uniform Loads (psf)

TRIPLE	DECK		SPAN (ft-in.)																		
	SPAN	GAGE	CRITERIA	2'-0"	3'-0"	4'-0"	5'-0"	5'-6"	6'-0"	6'-6"	7'-0"	7'-6"	8'-0"	8'-6"	9'-0"	9'-6"	10'-0"	11'-0"	12'-0"		
20/20	20/20	L/360	Stress	300	300	300	300	300	265	226	195	170	149	132	118	106	96	79	66		
			Shear	300	283	212	170	155	142	131	121	113	106	100	94	89	85	77	71		
			L/240	♦♦♦	♦♦♦	♦♦♦	♦♦♦	♦♦♦	♦♦♦	♦♦♦	♦♦♦	♦♦♦	♦♦♦	♦♦♦	♦♦♦	♦♦♦	♦♦♦	♦♦♦	♦♦♦	♦♦♦	
			L/180	♦♦♦	♦♦♦	♦♦♦	♦♦♦	♦♦♦	♦♦♦	♦♦♦	♦♦♦	♦♦♦	♦♦♦	♦♦♦	♦♦♦	♦♦♦	♦♦♦	♦♦♦	♦♦♦	♦♦♦	
			20/18	L/360	Stress	300	300	300	300	300	297	253	218	190	167	148	132	119	107	88	74
					Shear	300	205	154	123	112	103	95	88	82	77	72	68	65	62	56	51
	L/240	♦♦♦			♦♦♦	♦♦♦	♦♦♦	♦♦♦	♦♦♦	♦♦♦	♦♦♦	♦♦♦	♦♦♦	♦♦♦	♦♦♦	♦♦♦	♦♦♦	♦♦♦	♦♦♦	♦♦♦	
	L/180	♦♦♦			♦♦♦	♦♦♦	♦♦♦	♦♦♦	♦♦♦	♦♦♦	♦♦♦	♦♦♦	♦♦♦	♦♦♦	♦♦♦	♦♦♦	♦♦♦	♦♦♦	♦♦♦	♦♦♦	
	18/20	L/360			Stress	300	300	300	300	300	300	268	231	201	177	157	140	125	113	94	79
					Shear	300	300	230	184	168	154	142	132	123	115	108	102	97	92	84	77
			L/240	♦♦♦	♦♦♦	♦♦♦	♦♦♦	♦♦♦	♦♦♦	♦♦♦	♦♦♦	♦♦♦	♦♦♦	♦♦♦	♦♦♦	♦♦♦	♦♦♦	♦♦♦	♦♦♦	♦♦♦	
			L/180	♦♦♦	♦♦♦	♦♦♦	♦♦♦	♦♦♦	♦♦♦	♦♦♦	♦♦♦	♦♦♦	♦♦♦	♦♦♦	♦♦♦	♦♦♦	♦♦♦	♦♦♦	♦♦♦	♦♦♦	
18/18			L/360	Stress	300	300	300	300	300	300	300	282	245	216	191	170	153	138	114	96	
				Shear	300	300	278	222	202	185	171	159	148	139	131	123	117	111	101	93	
	L/240	♦♦♦		♦♦♦	♦♦♦	♦♦♦	♦♦♦	♦♦♦	♦♦♦	♦♦♦	♦♦♦	♦♦♦	♦♦♦	♦♦♦	♦♦♦	♦♦♦	♦♦♦	♦♦♦	♦♦♦		
	L/180	♦♦♦		♦♦♦	♦♦♦	♦♦♦	♦♦♦	♦♦♦	♦♦♦	♦♦♦	♦♦♦	♦♦♦	♦♦♦	♦♦♦	♦♦♦	♦♦♦	♦♦♦	♦♦♦	♦♦♦		
	18/16	L/360		Stress	300	300	300	300	300	300	300	293	256	225	199	177	159	144	119	100	
				Shear	300	291	218	175	159	146	134	125	116	109	103	97	92	87	79	73	
L/240			♦♦♦	♦♦♦	♦♦♦	♦♦♦	♦♦♦	♦♦♦	♦♦♦	♦♦♦	♦♦♦	♦♦♦	♦♦♦	♦♦♦	♦♦♦	♦♦♦	♦♦♦	♦♦♦	♦♦♦		
L/180			♦♦♦	♦♦♦	♦♦♦	♦♦♦	♦♦♦	♦♦♦	♦♦♦	♦♦♦	♦♦♦	♦♦♦	♦♦♦	♦♦♦	♦♦♦	♦♦♦	♦♦♦	♦♦♦	♦♦♦		
16/18			L/360	Stress	300	300	300	300	300	300	300	300	280	246	218	194	174	157	130	109	
				Shear	300	300	300	252	229	210	194	180	168	158	148	140	133	126	115	105	
	L/240	♦♦♦		♦♦♦	♦♦♦	♦♦♦	♦♦♦	♦♦♦	♦♦♦	♦♦♦	♦♦♦	♦♦♦	♦♦♦	♦♦♦	♦♦♦	♦♦♦	♦♦♦	♦♦♦	♦♦♦		
	L/180	♦♦♦		♦♦♦	♦♦♦	♦♦♦	♦♦♦	♦♦♦	♦♦♦	♦♦♦	♦♦♦	♦♦♦	♦♦♦	♦♦♦	♦♦♦	♦♦♦	♦♦♦	♦♦♦	♦♦♦		
	16/16	L/360		Stress	300	300	300	300	300	300	300	300	300	273	242	216	194	175	145	121	
				Shear	300	300	300	273	248	228	210	195	182	171	161	152	144	137	124	114	
L/240			♦♦♦	♦♦♦	♦♦♦	♦♦♦	♦♦♦	♦♦♦	♦♦♦	♦♦♦	♦♦♦	♦♦♦	♦♦♦	♦♦♦	♦♦♦	♦♦♦	♦♦♦	♦♦♦	♦♦♦		
L/180			♦♦♦	♦♦♦	♦♦♦	♦♦♦	♦♦♦	♦♦♦	♦♦♦	♦♦♦	♦♦♦	♦♦♦	♦♦♦	♦♦♦	♦♦♦	♦♦♦	♦♦♦	♦♦♦	♦♦♦		

Notes:
 1. Governing Values are in Bold Font.
 2. See additional footnotes on page 127.

Type PLN3™-CD or HSN3™-CD

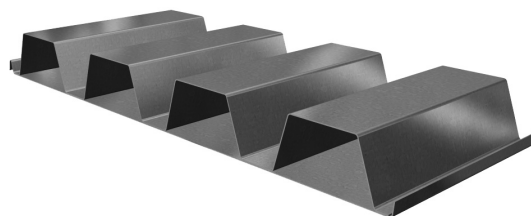

Allowable Uniform Loads (psf)

SPAN	DECK GAGE	CRITERIA	SPAN (ft.-in.)																
			4'-0"	5'-0"	6'-0"	7'-0"	8'-0"	9'-0"	10'-0"	11'-0"	12'-0"	13'-0"	14'-0"	15'-0"	16'-0"	17'-0"	18'-0"	19'-0"	20'-0"
SINGLE	20/20	Stress	300	300	281	206	158	125	101	83	70	60	52	45	39	35	31	28	25
		Shear	264	211	176	151	132	117	106	96	88	81	75	70	66	62	59	56	53
		L/360	***	***	***	***	***	95	69	52	40	31	25	20	17	14	12	10	9
		L/240	***	***	***	***	***	***	***	78	60	47	38	31	25	21	18	15	13
		L/180	***	***	***	***	***	***	***	***	***	***	50	41	34	28	24	20	17
		20/18	Stress	300	300	279	205	157	124	101	83	70	60	51	45	39	35	31	28
	Shear		245	196	163	140	122	109	98	89	82	75	70	65	61	58	54	51	49
	L/360		***	***	***	***	***	103	75	56	43	34	27	22	18	15	13	11	9
	L/240		***	***	***	***	***	***	***	***	65	51	41	33	28	23	19	16	14
	L/180		***	***	***	***	***	***	***	***	***	***	45	37	31	26	22	19	
	18/20		Stress	300	300	300	300	251	199	161	133	112	95	82	71	63	56	50	45
		Shear	290	232	193	165	145	129	116	105	97	89	83	77	72	68	64	61	58
L/360		***	***	***	***	***	121	88	66	51	40	32	26	22	18	15	13	11	
L/240		***	***	***	***	***	***	***	100	77	60	48	39	32	27	23	19	17	
L/180		***	***	***	***	***	***	***	***	***	80	64	52	43	36	30	26	22	
18/18		Stress	300	300	300	300	258	208	165	136	114	98	84	73	64	57	51	46	41
	Shear	300	300	268	229	201	178	161	146	134	124	115	107	100	94	89	85	80	
	L/360	***	***	***	***	188	132	96	72	56	44	35	28	23	20	16	14	12	
	L/240	***	***	***	***	***	***	144	108	83	66	52	43	35	29	25	21	18	
	L/180	***	***	***	***	***	***	***	***	111	87	70	57	47	39	33	28	24	
	18/16	Stress	300	300	300	300	259	205	166	137	115	98	85	74	65	57	51	46	41
Shear		300	300	252	216	189	168	151	137	126	116	108	101	95	89	84	80	76	
L/360		***	***	***	***	***	141	103	77	59	47	37	30	25	21	18	15	13	
L/240		***	***	***	***	***	***	***	116	89	70	56	46	38	31	26	22	19	
L/180		***	***	***	***	***	***	***	***	***	93	75	61	50	42	35	30	26	
16/18		Stress	300	300	300	300	300	273	221	183	154	131	113	98	86	77	68	61	55
	Shear	300	300	287	246	216	192	172	157	144	133	123	115	108	101	96	91	86	
	L/360	***	***	***	***	***	159	116	87	67	53	42	34	28	24	20	17	15	
	L/240	***	***	***	***	***	***	***	131	101	79	63	52	43	35	30	25	22	
	L/180	***	***	***	***	***	***	***	***	134	106	85	69	57	47	40	34	29	
	16/16	Stress	300	300	300	300	300	279	226	187	157	134	115	100	88	78	70	63	56
Shear		300	300	300	300	279	248	223	203	186	172	159	149	139	131	124	117	112	
L/360		***	***	***	***	243	170	124	93	72	57	45	37	30	25	21	18	16	
L/240		***	***	***	***	***	***	186	140	108	85	68	55	45	38	32	27	23	
L/180		***	***	***	***	***	***	***	***	144	113	91	74	61	51	43	36	31	

Notes:

1. Governing Values are in Bold Font.
2. See additional footnotes on page 127.

Type PLN3™-CD or HSN3™-CD

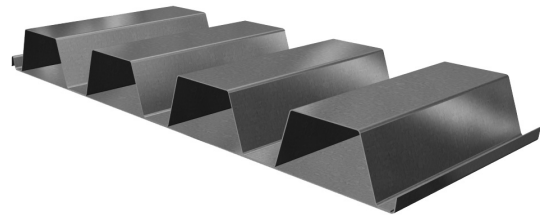

Allowable Uniform Loads (psf)

DECK	SPAN GAGE	CRITERIA	SPAN (ft-in.)																
			4'-0"	5'-0"	6'-0"	7'-0"	8'-0"	9'-0"	10'-0"	11'-0"	12'-0"	13'-0"	14'-0"	15'-0"	16'-0"	17'-0"	18'-0"	19'-0"	20'-0"
20/20	Stress	300	300	300	289	222	175	142	117	98	84	72	63	55	49	44	39	35	
		Shear	300	282	235	201	176	156	141	128	117	108	101	94	88	83	78	74	70
	L/360	◆◆◆	◆◆◆	◆◆◆	◆◆◆	◆◆◆	◆◆◆	◆◆◆	◆◆◆	◆◆◆	◆◆◆	◆◆◆	◆◆◆	◆◆◆	◆◆◆	◆◆◆	◆◆◆	◆◆◆	◆◆◆
		L/240	◆◆◆	◆◆◆	◆◆◆	◆◆◆	◆◆◆	◆◆◆	◆◆◆	◆◆◆	◆◆◆	◆◆◆	◆◆◆	◆◆◆	◆◆◆	◆◆◆	◆◆◆	◆◆◆	◆◆◆
		L/180	◆◆◆	◆◆◆	◆◆◆	◆◆◆	◆◆◆	◆◆◆	◆◆◆	◆◆◆	◆◆◆	◆◆◆	◆◆◆	◆◆◆	◆◆◆	◆◆◆	◆◆◆	◆◆◆	◆◆◆
20/18	Stress	300	300	300	300	250	198	160	132	111	95	82	71	63	55	49	44	40	
		Shear	299	239	199	171	149	133	120	109	100	92	85	80	75	70	66	63	60
	L/360	◆◆◆	◆◆◆	◆◆◆	◆◆◆	◆◆◆	◆◆◆	◆◆◆	◆◆◆	◆◆◆	◆◆◆	◆◆◆	◆◆◆	◆◆◆	◆◆◆	◆◆◆	◆◆◆	◆◆◆	◆◆◆
		L/240	◆◆◆	◆◆◆	◆◆◆	◆◆◆	◆◆◆	◆◆◆	◆◆◆	◆◆◆	◆◆◆	◆◆◆	◆◆◆	◆◆◆	◆◆◆	◆◆◆	◆◆◆	◆◆◆	◆◆◆
		L/180	◆◆◆	◆◆◆	◆◆◆	◆◆◆	◆◆◆	◆◆◆	◆◆◆	◆◆◆	◆◆◆	◆◆◆	◆◆◆	◆◆◆	◆◆◆	◆◆◆	◆◆◆	◆◆◆	◆◆◆
18/20	Stress	300	300	300	300	272	215	174	144	121	103	89	77	68	60	54	48	43	
		Shear	300	300	257	221	193	172	154	140	129	119	110	103	97	91	86	81	77
	L/360	◆◆◆	◆◆◆	◆◆◆	◆◆◆	◆◆◆	◆◆◆	◆◆◆	◆◆◆	◆◆◆	◆◆◆	◆◆◆	◆◆◆	◆◆◆	◆◆◆	◆◆◆	◆◆◆	◆◆◆	◆◆◆
		L/240	◆◆◆	◆◆◆	◆◆◆	◆◆◆	◆◆◆	◆◆◆	◆◆◆	◆◆◆	◆◆◆	◆◆◆	◆◆◆	◆◆◆	◆◆◆	◆◆◆	◆◆◆	◆◆◆	◆◆◆
		L/180	◆◆◆	◆◆◆	◆◆◆	◆◆◆	◆◆◆	◆◆◆	◆◆◆	◆◆◆	◆◆◆	◆◆◆	◆◆◆	◆◆◆	◆◆◆	◆◆◆	◆◆◆	◆◆◆	◆◆◆
18/18	Stress	300	300	300	300	300	254	206	170	143	122	105	92	80	71	64	57	52	
		Shear	300	300	300	300	268	238	214	195	178	165	153	143	134	126	119	113	107
	L/360	◆◆◆	◆◆◆	◆◆◆	◆◆◆	◆◆◆	◆◆◆	◆◆◆	◆◆◆	◆◆◆	◆◆◆	◆◆◆	◆◆◆	◆◆◆	◆◆◆	◆◆◆	◆◆◆	◆◆◆	◆◆◆
		L/240	◆◆◆	◆◆◆	◆◆◆	◆◆◆	◆◆◆	◆◆◆	◆◆◆	◆◆◆	◆◆◆	◆◆◆	◆◆◆	◆◆◆	◆◆◆	◆◆◆	◆◆◆	◆◆◆	◆◆◆
		L/180	◆◆◆	◆◆◆	◆◆◆	◆◆◆	◆◆◆	◆◆◆	◆◆◆	◆◆◆	◆◆◆	◆◆◆	◆◆◆	◆◆◆	◆◆◆	◆◆◆	◆◆◆	◆◆◆	◆◆◆
18/16	Stress	300	300	300	300	300	266	215	178	150	127	110	96	84	75	66	60	54	
		Shear	300	300	295	253	221	197	177	161	147	136	126	118	111	104	98	93	88
	L/360	◆◆◆	◆◆◆	◆◆◆	◆◆◆	◆◆◆	◆◆◆	◆◆◆	◆◆◆	◆◆◆	◆◆◆	◆◆◆	◆◆◆	◆◆◆	◆◆◆	◆◆◆	◆◆◆	◆◆◆	◆◆◆
		L/240	◆◆◆	◆◆◆	◆◆◆	◆◆◆	◆◆◆	◆◆◆	◆◆◆	◆◆◆	◆◆◆	◆◆◆	◆◆◆	◆◆◆	◆◆◆	◆◆◆	◆◆◆	◆◆◆	◆◆◆
		L/180	◆◆◆	◆◆◆	◆◆◆	◆◆◆	◆◆◆	◆◆◆	◆◆◆	◆◆◆	◆◆◆	◆◆◆	◆◆◆	◆◆◆	◆◆◆	◆◆◆	◆◆◆	◆◆◆	◆◆◆
16/18	Stress	300	300	300	300	300	299	242	200	168	143	123	108	95	84	75	67	61	
		Shear	300	300	300	300	287	255	230	209	192	177	164	153	144	135	128	121	115
	L/360	◆◆◆	◆◆◆	◆◆◆	◆◆◆	◆◆◆	◆◆◆	◆◆◆	◆◆◆	◆◆◆	◆◆◆	◆◆◆	◆◆◆	◆◆◆	◆◆◆	◆◆◆	◆◆◆	◆◆◆	◆◆◆
		L/240	◆◆◆	◆◆◆	◆◆◆	◆◆◆	◆◆◆	◆◆◆	◆◆◆	◆◆◆	◆◆◆	◆◆◆	◆◆◆	◆◆◆	◆◆◆	◆◆◆	◆◆◆	◆◆◆	◆◆◆
		L/180	◆◆◆	◆◆◆	◆◆◆	◆◆◆	◆◆◆	◆◆◆	◆◆◆	◆◆◆	◆◆◆	◆◆◆	◆◆◆	◆◆◆	◆◆◆	◆◆◆	◆◆◆	◆◆◆	◆◆◆
16/16	Stress	300	300	300	300	300	300	263	217	183	156	134	117	103	91	81	73	66	
		Shear	300	300	300	300	300	300	277	252	231	213	198	185	173	163	154	146	139
	L/360	◆◆◆	◆◆◆	◆◆◆	◆◆◆	◆◆◆	◆◆◆	◆◆◆	◆◆◆	◆◆◆	◆◆◆	◆◆◆	◆◆◆	◆◆◆	◆◆◆	◆◆◆	◆◆◆	◆◆◆	◆◆◆
		L/240	◆◆◆	◆◆◆	◆◆◆	◆◆◆	◆◆◆	◆◆◆	◆◆◆	◆◆◆	◆◆◆	◆◆◆	◆◆◆	◆◆◆	◆◆◆	◆◆◆	◆◆◆	◆◆◆	◆◆◆
		L/180	◆◆◆	◆◆◆	◆◆◆	◆◆◆	◆◆◆	◆◆◆	◆◆◆	◆◆◆	◆◆◆	◆◆◆	◆◆◆	◆◆◆	◆◆◆	◆◆◆	◆◆◆	◆◆◆	◆◆◆

Notes:
 1. Governing Values are in Bold Font.
 2. See additional footnotes on page 127.

Type PLN3™-CD or HSN3™-CD

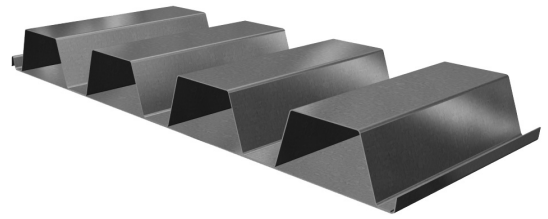

Allowable Uniform Loads (psf)

SPAN	DECK GAGE	CRITERIA	SPAN (ft.-in.)																			
			4'-0"	5'-0"	6'-0"	7'-0"	8'-0"	9'-0"	10'-0"	11'-0"	12'-0"	13'-0"	14'-0"	15'-0"	16'-0"	17'-0"	18'-0"	19'-0"	20'-0"			
20/20	TRIPLE	Stress	300	300	300	289	222	175	142	117	98	84	72	63	55	49	44	39	44			
		Shear	300	282	235	201	176	156	141	128	117	108	101	94	88	83	78	74	66			
		L/360	♦♦♦	♦♦♦	♦♦♦	♦♦♦	♦♦♦	♦♦♦	♦♦♦	♦♦♦	♦♦♦	96	76	61	49	41	34	29	24	16		
		L/240	♦♦♦	♦♦♦	♦♦♦	♦♦♦	♦♦♦	♦♦♦	♦♦♦	♦♦♦	♦♦♦	♦♦♦	♦♦♦	♦♦♦	♦♦♦	♦♦♦	♦♦♦	♦♦♦	43	36	24	
		L/180	♦♦♦	♦♦♦	♦♦♦	♦♦♦	♦♦♦	♦♦♦	♦♦♦	♦♦♦	♦♦♦	♦♦♦	♦♦♦	♦♦♦	♦♦♦	♦♦♦	♦♦♦	♦♦♦	♦♦♦	♦♦♦	♦♦♦	33
20/18	TRIPLE	Stress	300	300	300	300	250	198	160	132	111	95	82	71	63	55	49	44	50			
		Shear	299	239	199	171	149	133	120	109	100	92	85	80	75	70	66	63	61			
		L/360	♦♦♦	♦♦♦	♦♦♦	♦♦♦	♦♦♦	♦♦♦	♦♦♦	♦♦♦	♦♦♦	♦♦♦	♦♦♦	82	66	54	44	37	31	26	18	
		L/240	♦♦♦	♦♦♦	♦♦♦	♦♦♦	♦♦♦	♦♦♦	♦♦♦	♦♦♦	♦♦♦	♦♦♦	♦♦♦	♦♦♦	♦♦♦	♦♦♦	♦♦♦	55	47	40	27	
		L/180	♦♦♦	♦♦♦	♦♦♦	♦♦♦	♦♦♦	♦♦♦	♦♦♦	♦♦♦	♦♦♦	♦♦♦	♦♦♦	♦♦♦	♦♦♦	♦♦♦	♦♦♦	♦♦♦	♦♦♦	♦♦♦	♦♦♦	35
18/20	TRIPLE	Stress	300	300	300	300	272	215	174	144	121	103	89	77	68	60	54	48	54			
		Shear	300	300	257	221	193	172	154	140	129	119	110	103	97	91	86	81	72			
		L/360	♦♦♦	♦♦♦	♦♦♦	♦♦♦	♦♦♦	♦♦♦	♦♦♦	♦♦♦	♦♦♦	♦♦♦	♦♦♦	97	77	63	52	43	36	31	21	
		L/240	♦♦♦	♦♦♦	♦♦♦	♦♦♦	♦♦♦	♦♦♦	♦♦♦	♦♦♦	♦♦♦	♦♦♦	♦♦♦	♦♦♦	♦♦♦	♦♦♦	♦♦♦	♦♦♦	♦♦♦	46	31	
		L/180	♦♦♦	♦♦♦	♦♦♦	♦♦♦	♦♦♦	♦♦♦	♦♦♦	♦♦♦	♦♦♦	♦♦♦	♦♦♦	♦♦♦	♦♦♦	♦♦♦	♦♦♦	♦♦♦	♦♦♦	♦♦♦	♦♦♦	42
18/18	TRIPLE	Stress	300	300	300	300	300	254	206	170	143	122	105	92	80	71	64	57	64			
		Shear	300	300	300	300	268	238	214	195	178	165	153	143	134	126	119	113	100			
		L/360	♦♦♦	♦♦♦	♦♦♦	♦♦♦	♦♦♦	♦♦♦	♦♦♦	♦♦♦	♦♦♦	134	105	84	69	56	47	40	34	23		
		L/240	♦♦♦	♦♦♦	♦♦♦	♦♦♦	♦♦♦	♦♦♦	♦♦♦	♦♦♦	♦♦♦	♦♦♦	♦♦♦	♦♦♦	♦♦♦	♦♦♦	♦♦♦	♦♦♦	♦♦♦	♦♦♦	♦♦♦	34
		L/180	♦♦♦	♦♦♦	♦♦♦	♦♦♦	♦♦♦	♦♦♦	♦♦♦	♦♦♦	♦♦♦	♦♦♦	♦♦♦	♦♦♦	♦♦♦	♦♦♦	♦♦♦	♦♦♦	♦♦♦	♦♦♦	♦♦♦	45
18/16	TRIPLE	Stress	300	300	300	300	300	266	215	178	150	127	110	96	84	75	66	60	67			
		Shear	300	300	295	253	221	197	177	161	147	136	126	118	111	104	98	93	92			
		L/360	♦♦♦	♦♦♦	♦♦♦	♦♦♦	♦♦♦	♦♦♦	♦♦♦	♦♦♦	♦♦♦	143	113	90	73	60	50	42	36	24		
		L/240	♦♦♦	♦♦♦	♦♦♦	♦♦♦	♦♦♦	♦♦♦	♦♦♦	♦♦♦	♦♦♦	♦♦♦	♦♦♦	♦♦♦	♦♦♦	♦♦♦	♦♦♦	♦♦♦	♦♦♦	64	54	36
		L/180	♦♦♦	♦♦♦	♦♦♦	♦♦♦	♦♦♦	♦♦♦	♦♦♦	♦♦♦	♦♦♦	♦♦♦	♦♦♦	♦♦♦	♦♦♦	♦♦♦	♦♦♦	♦♦♦	♦♦♦	♦♦♦	♦♦♦	48
16/18	TRIPLE	Stress	300	300	300	300	300	299	242	200	168	143	123	108	95	84	75	67	76			
		Shear	300	300	300	300	287	255	230	209	192	177	164	153	144	135	128	121	108			
		L/360	♦♦♦	♦♦♦	♦♦♦	♦♦♦	♦♦♦	♦♦♦	♦♦♦	♦♦♦	♦♦♦	162	127	102	83	68	57	48	41	27		
		L/240	♦♦♦	♦♦♦	♦♦♦	♦♦♦	♦♦♦	♦♦♦	♦♦♦	♦♦♦	♦♦♦	♦♦♦	♦♦♦	♦♦♦	♦♦♦	♦♦♦	♦♦♦	♦♦♦	♦♦♦	72	61	41
		L/180	♦♦♦	♦♦♦	♦♦♦	♦♦♦	♦♦♦	♦♦♦	♦♦♦	♦♦♦	♦♦♦	♦♦♦	♦♦♦	♦♦♦	♦♦♦	♦♦♦	♦♦♦	♦♦♦	♦♦♦	♦♦♦	♦♦♦	55
16/16	TRIPLE	Stress	300	300	300	300	300	300	263	217	183	156	134	117	103	91	81	73	82			
		Shear	300	300	300	300	300	300	277	252	231	213	198	185	173	163	154	146	139			
		L/360	♦♦♦	♦♦♦	♦♦♦	♦♦♦	♦♦♦	♦♦♦	♦♦♦	♦♦♦	♦♦♦	173	136	109	89	73	61	51	44	29		
		L/240	♦♦♦	♦♦♦	♦♦♦	♦♦♦	♦♦♦	♦♦♦	♦♦♦	♦♦♦	♦♦♦	♦♦♦	♦♦♦	♦♦♦	♦♦♦	♦♦♦	♦♦♦	♦♦♦	♦♦♦	77	65	44
		L/180	♦♦♦	♦♦♦	♦♦♦	♦♦♦	♦♦♦	♦♦♦	♦♦♦	♦♦♦	♦♦♦	♦♦♦	♦♦♦	♦♦♦	♦♦♦	♦♦♦	♦♦♦	♦♦♦	♦♦♦	♦♦♦	♦♦♦	59

Notes:
 1. Governing Values are in Bold Font.
 2. See additional footnotes on page 127.

Type PLN™ -24-CD or N-24-CD



Allowable Uniform Loads (psf)

DECK	SPAN GAGE	CRITERIA	SPAN (ft-in.)																	
			4'-0"	5'-0"	6'-0"	7'-0"	8'-0"	9'-0"	10'-0"	11'-0"	12'-0"	13'-0"	14'-0"	15'-0"	16'-0"	17'-0"	18'-0"	19'-0"	20'-0"	
20/20	SINGLE	Stress	300	300	288	211	162	128	104	86	72	61	53	46	40	36	32	29	35	
		Shear	279	223	186	160	140	124	112	102	93	86	80	74	70	66	62	59	74	
		L/360	♦♦♦	♦♦♦	♦♦♦	♦♦♦	♦♦♦	♦♦♦	101	74	55	43	33	27	22	18	15	13	11	22
		L/240	♦♦♦	♦♦♦	♦♦♦	♦♦♦	♦♦♦	♦♦♦	♦♦♦	♦♦♦	83	64	50	40	33	27	22	19	16	33
		L/180	♦♦♦	♦♦♦	♦♦♦	♦♦♦	♦♦♦	♦♦♦	♦♦♦	♦♦♦	♦♦♦	♦♦♦	♦♦♦	♦♦♦	♦♦♦	44	36	30	25	21
20/18	SINGLE	Stress	300	300	286	210	161	127	103	85	72	61	53	46	40	36	32	29	45	
		Shear	261	209	174	149	130	116	104	95	87	80	75	70	65	61	58	55	57	
		L/360	♦♦♦	♦♦♦	♦♦♦	♦♦♦	♦♦♦	♦♦♦	111	81	61	47	37	29	24	20	16	14	12	24
		L/240	♦♦♦	♦♦♦	♦♦♦	♦♦♦	♦♦♦	♦♦♦	♦♦♦	♦♦♦	♦♦♦	70	55	44	36	30	25	21	18	36
		L/180	♦♦♦	♦♦♦	♦♦♦	♦♦♦	♦♦♦	♦♦♦	♦♦♦	♦♦♦	♦♦♦	♦♦♦	♦♦♦	♦♦♦	♦♦♦	39	33	28	24	♦♦♦
18/20	SINGLE	Stress	300	300	300	300	252	199	161	133	112	95	82	72	63	56	50	45	43	
		Shear	300	243	203	174	152	135	122	110	101	93	87	81	76	71	68	64	81	
		L/360	♦♦♦	♦♦♦	♦♦♦	♦♦♦	♦♦♦	♦♦♦	130	95	71	55	43	34	28	23	19	16	14	28
		L/240	♦♦♦	♦♦♦	♦♦♦	♦♦♦	♦♦♦	♦♦♦	♦♦♦	♦♦♦	107	82	65	52	42	35	29	24	21	♦♦♦
		L/180	♦♦♦	♦♦♦	♦♦♦	♦♦♦	♦♦♦	♦♦♦	♦♦♦	♦♦♦	♦♦♦	♦♦♦	86	69	56	46	38	32	28	♦♦♦
18/18	SINGLE	Stress	300	300	300	300	258	204	165	137	115	98	84	73	65	57	51	46	53	
		Shear	300	300	283	243	213	189	170	155	142	131	121	113	106	100	94	89	102	
		L/360	♦♦♦	♦♦♦	♦♦♦	♦♦♦	♦♦♦	203	142	104	78	60	47	38	31	25	21	18	15	31
		L/240	♦♦♦	♦♦♦	♦♦♦	♦♦♦	♦♦♦	♦♦♦	156	117	90	71	57	46	38	32	27	23	47	
		L/180	♦♦♦	♦♦♦	♦♦♦	♦♦♦	♦♦♦	♦♦♦	♦♦♦	♦♦♦	♦♦♦	♦♦♦	94	76	61	51	42	36	30	♦♦♦
18/16	SINGLE	Stress	300	300	300	300	263	208	169	139	117	100	86	75	66	58	52	47	66	
		Shear	300	300	268	230	201	179	161	146	134	124	115	107	101	95	89	85	77	
		L/360	♦♦♦	♦♦♦	♦♦♦	♦♦♦	♦♦♦	153	111	84	64	51	41	33	27	23	19	16	34	
		L/240	♦♦♦	♦♦♦	♦♦♦	♦♦♦	♦♦♦	♦♦♦	♦♦♦	126	97	76	61	49	41	34	29	24	50	
		L/180	♦♦♦	♦♦♦	♦♦♦	♦♦♦	♦♦♦	♦♦♦	♦♦♦	♦♦♦	♦♦♦	♦♦♦	♦♦♦	81	66	54	45	38	32	♦♦♦
16/18	SINGLE	Stress	300	300	300	300	300	277	224	185	156	133	114	100	88	78	69	62	60	
		Shear	300	300	300	259	226	201	181	165	151	139	129	121	113	107	101	95	116	
		L/360	♦♦♦	♦♦♦	♦♦♦	♦♦♦	♦♦♦	173	126	95	73	57	46	37	31	26	22	18	38	
		L/240	♦♦♦	♦♦♦	♦♦♦	♦♦♦	♦♦♦	♦♦♦	♦♦♦	142	109	86	69	56	46	39	32	28	57	
		L/180	♦♦♦	♦♦♦	♦♦♦	♦♦♦	♦♦♦	♦♦♦	♦♦♦	♦♦♦	146	115	92	75	62	51	43	37	♦♦♦	
16/16	SINGLE	Stress	300	300	300	300	300	282	229	189	159	135	117	102	89	79	71	63	74	
		Shear	300	300	300	300	295	262	236	215	197	182	169	157	148	139	131	124	120	
		L/360	♦♦♦	♦♦♦	♦♦♦	♦♦♦	♦♦♦	266	186	136	102	79	62	50	40	33	28	23	20	41
		L/240	♦♦♦	♦♦♦	♦♦♦	♦♦♦	♦♦♦	♦♦♦	204	153	118	93	74	60	50	42	35	30	61	
		L/180	♦♦♦	♦♦♦	♦♦♦	♦♦♦	♦♦♦	♦♦♦	♦♦♦	♦♦♦	157	124	99	81	66	55	47	40	♦♦♦	

Notes:
 1. Governing Values are in Bold Font.
 2. See additional footnotes on page 127.

Type PLN™ -24-CD or N-24-CD



Allowable Uniform Loads (psf)

DECK	SPAN GAGE CRITERIA	SPAN (ft.-in.)																	
		4'-0"	5'-0"	6'-0"	7'-0"	8'-0"	9'-0"	10'-0"	11'-0"	12'-0"	13'-0"	14'-0"	15'-0"	16'-0"	17'-0"	18'-0"	19'-0"	20'-0"	
20/20	Stress	300	300	300	288	221	174	141	117	98	84	72	63	55	49	44	39	35	
	Shear	300	298	248	213	186	166	149	135	124	115	106	99	93	88	83	78	74	
	L/360	***	***	***	***	***	***	***	***	***	81	65	52	43	36	30	26	22	
	L/240	***	***	***	***	***	***	***	***	***	***	***	***	***	***	***	***	39	33
	L/180	***	***	***	***	***	***	***	***	***	***	***	***	***	***	***	***	***	***
20/18	Stress	300	300	300	300	284	225	182	150	126	108	93	81	71	63	56	50	45	
	Shear	287	230	192	164	144	128	115	104	96	88	82	77	72	68	64	60	57	
	L/360	***	***	***	***	***	***	***	***	***	88	71	57	47	39	33	28	24	
	L/240	***	***	***	***	***	***	***	***	***	***	***	***	***	59	50	42	36	
	L/180	***	***	***	***	***	***	***	***	***	***	***	***	***	***	***	***	***	***
18/20	Stress	300	300	300	300	266	210	170	141	118	101	87	76	67	59	53	47	43	
	Shear	300	300	270	231	203	180	162	147	135	125	116	108	101	95	90	85	81	
	L/360	***	***	***	***	***	***	***	***	***	***	83	67	56	46	39	33	28	
	L/240	***	***	***	***	***	***	***	***	***	***	***	***	***	***	***	***	***	
	L/180	***	***	***	***	***	***	***	***	***	***	***	***	***	***	***	***	***	***
18/18	Stress	300	300	300	300	300	261	211	174	147	125	108	94	82	73	65	58	53	
	Shear	300	300	300	291	255	227	204	185	170	157	146	136	127	120	113	107	102	
	L/360	***	***	***	***	***	***	***	***	144	114	91	74	61	51	43	36	31	
	L/240	***	***	***	***	***	***	***	***	***	***	***	***	***	***	64	55	47	
	L/180	***	***	***	***	***	***	***	***	***	***	***	***	***	***	***	***	***	***
18/16	Stress	300	300	300	300	300	300	264	218	183	156	134	117	103	91	81	73	66	
	Shear	300	300	258	221	193	172	155	141	129	119	110	103	97	91	86	81	77	
	L/360	***	***	***	***	***	***	***	***	***	***	98	79	65	55	46	39	34	
	L/240	***	***	***	***	***	***	***	***	***	***	***	***	***	82	69	59	50	
	L/180	***	***	***	***	***	***	***	***	***	***	***	***	***	***	***	***	***	***
16/18	Stress	300	300	300	300	300	296	240	198	167	142	122	107	94	83	74	66	60	
	Shear	300	300	300	300	291	259	233	212	194	179	166	155	146	137	129	123	116	
	L/360	***	***	***	***	***	***	***	***	***	138	111	90	74	62	52	44	38	
	L/240	***	***	***	***	***	***	***	***	***	***	***	***	***	***	***	66	57	
	L/180	***	***	***	***	***	***	***	***	***	***	***	***	***	***	***	***	***	***
16/16	Stress	300	300	300	300	300	300	295	244	205	175	151	131	115	102	91	82	74	
	Shear	300	300	300	300	300	266	240	218	200	184	171	160	150	141	133	126	120	
	L/360	***	***	***	***	***	***	***	***	***	189	149	119	97	80	67	56	48	41
	L/240	***	***	***	***	***	***	***	***	***	***	***	***	***	***	100	84	72	61
	L/180	***	***	***	***	***	***	***	***	***	***	***	***	***	***	***	***	***	***

Notes:
 1. Governing Values are in Bold Font.
 2. See additional footnotes on page 127.

Type PLN™ -24-CD or N-24-CD



Allowable Uniform Loads (psf)

DECK	SPAN	GAGE	CRITERIA	SPAN (ft-in.)																		
				4'-0"	5'-0"	6'-0"	7'-0"	8'-0"	9'-0"	10'-0"	11'-0"	12'-0"	13'-0"	14'-0"	15'-0"	16'-0"	17'-0"	18'-0"	19'-0"	20'-0"		
20/20			Stress	300	300	300	300	276	218	177	146	123	105	90	78	69	61	55	49	44		
			Shear	300	279	233	200	175	155	140	127	116	107	100	93	87	82	78	74	70		
			L/360	***	***	***	***	***	***	139	104	80	63	51	41	34	28	24	20	17		
			L/240	***	***	***	***	***	***	***	***	***	***	95	76	62	51	42	36	30	26	
			L/180	***	***	***	***	***	***	***	***	***	***	***	***	***	68	56	48	40	35	
20/18			Stress	300	300	300	300	300	281	227	188	158	135	116	101	89	79	70	63	57		
			Shear	299	239	200	171	150	133	120	109	100	92	86	80	75	70	67	63	60		
			L/360	***	***	***	***	***	***	***	***	***	88	69	55	45	37	31	26	22	19	
			L/240	***	***	***	***	***	***	***	***	***	***	83	67	56	46	39	33	28		
			L/180	***	***	***	***	***	***	***	***	***	***	***	***	***	74	62	52	44	38	
18/20			Stress	300	300	300	300	300	263	213	176	148	126	109	95	83	74	66	59	53		
			Shear	300	300	253	217	190	169	152	138	127	117	108	101	95	89	84	80	76		
			L/360	***	***	***	***	***	***	***	***	134	103	81	65	53	43	36	31	26	22	
			L/240	***	***	***	***	***	***	***	***	***	***	***	97	79	65	54	46	39	33	
			L/180	***	***	***	***	***	***	***	***	***	***	***	***	***	***	72	61	52	45	
18/18			Stress	300	300	300	300	300	300	264	218	183	156	135	117	103	91	81	73	66		
			Shear	300	300	300	300	266	236	212	193	177	163	152	142	133	125	118	112	106		
			L/360	***	***	***	***	***	***	***	195	147	113	89	71	58	48	40	33	28	24	
			L/240	***	***	***	***	***	***	***	***	***	170	133	107	87	72	60	50	43	37	
			L/180	***	***	***	***	***	***	***	***	***	***	***	***	***	116	95	80	67	57	49
18/16			Stress	300	300	300	300	300	300	300	272	229	195	168	146	129	114	102	91	82		
			Shear	300	300	268	230	201	179	161	146	134	124	115	107	101	95	89	85	81		
			L/360	***	***	***	***	***	***	***	***	***	121	95	76	62	51	43	36	31	26	
			L/240	***	***	***	***	***	***	***	***	***	***	***	115	93	77	64	54	46	39	
			L/180	***	***	***	***	***	***	***	***	***	***	***	***	***	***	85	72	61	52	
16/18			Stress	300	300	300	300	300	300	300	248	208	177	153	133	117	104	93	83	75		
			Shear	300	300	300	300	283	252	226	206	189	174	162	151	142	133	126	119	113		
			L/360	***	***	***	***	***	***	***	***	179	138	108	87	70	58	48	41	35	30	
			L/240	***	***	***	***	***	***	***	***	***	***	162	130	106	87	73	61	52	45	
			L/180	***	***	***	***	***	***	***	***	***	***	***	***	***	***	116	97	81	69	59
16/16			Stress	300	300	300	300	300	300	300	300	256	218	188	164	144	128	114	102	92		
			Shear	300	300	300	300	300	277	250	227	208	192	178	166	156	147	139	131	125		
			L/360	***	***	***	***	***	***	***	***	192	148	117	93	76	63	52	44	37	32	
			L/240	***	***	***	***	***	***	***	***	***	***	***	175	140	114	94	78	66	56	48
			L/180	***	***	***	***	***	***	***	***	***	***	***	***	***	152	125	104	88	75	64

Notes:
 1. Governing Values are in Bold Font.
 2. See additional footnotes on page 127.

Type PLB™ -CD

- 36/7 Weld Pattern at Supports
- Sidelaps Connected with PunchLok II Tool

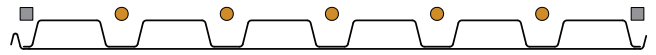

Allowable Diaphragm Shear Strength, q (plf) and Flexibility Factors, F ((in./lb)x10⁶)

DECK GAGE	SIDELAP ATTACHMENT	SPAN (ft-in.)									
		4'-0"	5'-0"	6'-0"	7'-0"	8'-0"	9'-0"	10'-0"	11'-0"	12'-0"	
20/20	VSC2 @ 24"	q	1759	1607	1356	1301	1138	1116	1004	1002	918
		F	6.3-2R	6.6-2R	7.6-2R	7.7-2R	8.6-2R	8.5-2R	9.3-2R	9.2-2R	9.9-2R
	VSC2 @ 18"	q	1963	1775	1503	1428	1371	1225	1199	1178	1081
		F	5.5-1R	5.9-1R	6.8-2R	6.9-1R	7.1-1R	7.8-2R	7.8-1R	7.8-1R	8.4-2R
	VSC2 @ 12"	q	2158	1938	1786	1674	1589	1522	1467	1356	1139
		F	5-1R	5.4-1R	5.7-1R	5.9-1R	6.1-1R	6.2-1R	6.4-1R	6.5-1R	6.6-1R
	VSC2 @ 8"	q	2520	2394	2182	2135	2001	1983	1641	1356	1139
		F	4.2-1R	4.3-1R	4.6-1R	4.7-1R	4.9-1R	4.9-1R	5-1R	5+0R	5.2+0R
	VSC2 @ 6"	q	2847	2668	2543	2450	2379	2026	1641	1356	1139
		F	3.8-1R	3.9+0R	4+0R	4.1+0R	4.2+0R	4.2+0R	4.3+0R	4.3+0R	4.3+0R
	VSC2 @ 4"	q	3394	3254	3155	3081	2564	2026	1641	1356	1139
		F	3.2+0R	3.2+0R	3.3+0R	3.3+0R	3.4+0R	3.4+0R	3.4+0R	3.4+0R	3.4+0R
20/18	VSC2 @ 24"	q	2103	1983	1678	1650	1455	1458	1311	1328	1217
		F	4.8-1R	4.7-1R	5.5-1R	5.3-1R	5.9-1R	5.7-1R	6.2-1R	6-1R	6.4-1R
	VSC2 @ 18"	q	2411	2236	1901	1842	1797	1612	1598	1450	1219
		F	4-1R	4.1-1R	4.7-1R	4.7-1R	4.7-1R	5.1-1R	5-1R	5-1R	5.3-1R
	VSC2 @ 12"	q	2700	2477	2323	2209	2122	2054	1755	1450	1219
		F	3.5-1R	3.7+0R	3.8+0R	3.9+0R	4+0R	4+0R	4.1+0R	4.1+0R	4.1+0R
	VSC2 @ 8"	q	3218	3126	2892	2870	2717	2166	1755	1450	1219
		F	2.9+0R	2.9+0R	3.1+0R	3+0R	3.2+0R	3.1+0R	3.2+0R	3.2+0R	3.2+0R
	VSC2 @ 6"	q	3659	3497	3382	3298	2742	2166	1755	1450	1219
		F	2.6+0R	2.6+0R	2.7+0R	2.7+0R	2.7+0R	2.7+0R	2.7+0R	2.8+0R	2.8+0R
	VSC2 @ 4"	q	4341	4228	4147	3581	2742	2166	1755	1450	1219
		F	2.2+0R	2.2+0R	2.2+0R	2.2+0R	2.2+0R	2.2+0R	2.3+0R	2.3+0R	2.3+0R
18/20	VSC2 @ 24"	q	1861	1690	1426	1361	1191	1163	1047	1040	954
		F	5.7-2R	6-2R	6.9-2R	7.1-2R	7.9-2R	7.9-2R	8.7-2R	8.6-2R	9.3-2R
	VSC2 @ 18"	q	2065	1859	1573	1488	1424	1272	1242	1217	1116
		F	5-1R	5.4-1R	6.2-2R	6.4-1R	6.6-1R	7.3-2R	7.3-2R	7.4-1R	7.9-2R
	VSC2 @ 12"	q	2261	2023	1857	1736	1643	1571	1512	1463	1422
		F	4.6-1R	5-1R	5.3-1R	5.5-1R	5.7-1R	5.9-1R	6-1R	6.1-1R	6.3-1R
	VSC2 @ 8"	q	2628	2484	2258	2202	2060	2037	1937	1930	1647
		F	3.9-1R	4-1R	4.3-1R	4.4-1R	4.6-1R	4.6-1R	4.8-1R	4.7-1R	4.9-1R
	VSC2 @ 6"	q	2961	2764	2625	2523	2444	2382	2332	1960	1647
		F	3.5-1R	3.6+0R	3.8+0R	3.8+0R	3.9+0R	4+0R	4+0R	4.1+0R	4.1+0R
	VSC2 @ 4"	q	3526	3368	3257	3174	3111	2928	2372	1960	1647
		F	2.9+0R	3+0R	3.1+0R	3.1+0R	3.2+0R	3.2+0R	3.2+0R	3.2+0R	3.3+0R
18/18	VSC2 @ 24"	q	2103	1983	1678	1650	1455	1458	1311	1328	1217
		F	4.4-1R	4.4-1R	5.1-1R	5-1R	5.6-1R	5.4-1R	5.9-1R	5.7-1R	6.1-1R
	VSC2 @ 18"	q	2411	2236	1901	1842	1797	1612	1598	1587	1462
		F	3.8-1R	3.9-1R	4.4-1R	4.4-1R	4.4-1R	4.9-1R	4.8-1R	4.8-1R	5.1-1R
	VSC2 @ 12"	q	2700	2477	2323	2209	2122	2054	1998	1953	1765
		F	3.3-1R	3.5-1R	3.6+0R	3.7+0R	3.8+0R	3.8+0R	3.9+0R	3.9+0R	4+0R
	VSC2 @ 8"	q	3218	3126	2892	2870	2717	2718	2541	2100	1765
		F	2.8+0R	2.8+0R	2.9+0R	2.9+0R	3+0R	3+0R	3+0R	3+0R	3.1+0R
	VSC2 @ 6"	q	3659	3497	3382	3298	3232	3138	2541	2100	1765
		F	2.4+0R	2.5+0R	2.5+0R	2.5+0R	2.6+0R	2.6+0R	2.6+0R	2.6+0R	2.6+0R
	VSC2 @ 4"	q	4341	4228	4147	4087	3971	3138	2541	2100	1765
		F	2+0R	2.1+0R	2.1+0R	2.1+0R	2.1+0R	2.1+0R	2.1+0R	2.1+0R	2.1+0R

See footnotes on page 127.

Type PLB™ -CD

- 36/7 Weld Pattern at Supports
- Sidelaps Connected with PunchLok II Tool



Allowable Diaphragm Shear Strength, q (plf) and Flexibility Factors, F ((in./lb)x10⁶)

DECK GAGE	SIDELAP ATTACHMENT	SPAN (ft-in.)									
		4'-0"	5'-0"	6'-0"	7'-0"	8'-0"	9'-0"	10'-0"	11'-0"	12'-0"	
18/16	VSC2 @ 24"	q	2345	2273	1929	1936	1711	1741	1577	1614	1483
		F	4-1R	3.9-1R	4.5-1R	4.4-1R	4.9-1R	4.7-1R	5.1-1R	5-1R	5.3-1R
	VSC2 @ 18"	q	2751	2605	2224	2189	2163	1945	1948	1950	1800
		F	3.3-1R	3.4-1R	3.9-1R	3.9-1R	3.9+0R	4.2-1R	4.2+0R	4.1+0R	4.4+0R
	VSC2 @ 12"	q	3123	2916	2771	2665	2583	2519	2467	2219	1865
		F	2.9+0R	3+0R	3.1+0R	3.2+0R	3.3+0R	3.3+0R	3.3+0R	3.4+0R	3.4+0R
	VSC2 @ 8"	q	3765	3715	3477	3481	3322	3315	2685	2219	1865
		F	2.4+0R	2.4+0R	2.5+0R	2.5+0R	2.6+0R	2.5+0R	2.6+0R	2.6+0R	2.6+0R
	VSC2 @ 6"	q	4280	4145	4050	3979	3925	3315	2685	2219	1865
		F	2.1+0R	2.1+0R	2.2+0R	2.2+0R	2.2+0R	2.2+0R	2.2+0R	2.2+0R	2.2+0R
	VSC2 @ 4"	q	5014	4929	4869	4825	4196	3315	2685	2219	1865
		F	1.8+0R	1.8+0R	1.8+0R	1.8+0R	1.8+0R	1.8+0R	1.8+0R	1.8+0R	1.8+0R
16/18	VSC2 @ 24"	q	2103	1983	1678	1650	1455	1458	1311	1328	1217
		F	4.1-1R	4.2-1R	4.8-1R	4.7-1R	5.3-1R	5.1-1R	5.6-1R	5.5-1R	5.9-1R
	VSC2 @ 18"	q	2411	2236	1901	1842	1797	1612	1598	1587	1462
		F	3.5-1R	3.7-1R	4.2-1R	4.2-1R	4.2-1R	4.6-1R	4.6-1R	4.6-1R	4.9-1R
	VSC2 @ 12"	q	2700	2477	2323	2209	2122	2054	1998	1953	1914
		F	3.1-1R	3.3-1R	3.4+0R	3.5+0R	3.6+0R	3.7+0R	3.7+0R	3.8+0R	3.8+0R
	VSC2 @ 8"	q	3218	3126	2892	2870	2717	2718	2607	2619	2355
		F	2.6+0R	2.6+0R	2.8+0R	2.7+0R	2.9+0R	2.8+0R	2.9+0R	2.9+0R	3+0R
	VSC2 @ 6"	q	3659	3497	3382	3298	3232	3181	3138	2802	2355
		F	2.3+0R	2.3+0R	2.4+0R	2.4+0R	2.4+0R	2.5+0R	2.5+0R	2.5+0R	2.5+0R
	VSC2 @ 4"	q	4341	4228	4147	4087	4041	4004	3391	2802	2355
		F	1.9+0R	1.9+0R	2+0R	2+0R	2+0R	2+0R	2+0R	2+0R	2+0R
16/16	VSC2 @ 24"	q	2345	2273	1929	1936	1711	1741	1577	1614	1483
		F	3.7-1R	3.7-1R	4.3-1R	4.2-1R	4.7-1R	4.5-1R	4.9-1R	4.8-1R	5.1-1R
	VSC2 @ 18"	q	2751	2605	2224	2189	2163	1945	1948	1950	1800
		F	3.2-1R	3.2-1R	3.7-1R	3.7-1R	3.7-1R	4.1-1R	4-1R	4+0R	4.3-1R
	VSC2 @ 12"	q	3123	2916	2771	2665	2583	2519	2467	2424	2388
		F	2.8+0R	2.9+0R	3+0R	3.1+0R	3.1+0R	3.2+0R	3.2+0R	3.3+0R	3.3+0R
	VSC2 @ 8"	q	3765	3715	3477	3481	3322	3343	3225	2964	2491
		F	2.3+0R	2.3+0R	2.4+0R	2.4+0R	2.5+0R	2.4+0R	2.5+0R	2.5+0R	2.6+0R
	VSC2 @ 6"	q	4280	4145	4050	3979	3925	3882	3587	2964	2491
		F	2+0R	2+0R	2.1+0R	2.1+0R	2.1+0R	2.1+0R	2.1+0R	2.1+0R	2.2+0R
	VSC2 @ 4"	q	5014	4929	4869	4825	4791	4428	3587	2964	2491
		F	1.7+0R	1.7+0R	1.7+0R	1.7+0R	1.7+0R	1.7+0R	1.7+0R	1.7+0R	1.7+0R

See footnotes on page 127.

Type PLN3™ -CD

- 32/5 Weld Pattern at Supports
- Sidelaps Connected with PunchLok II Tool

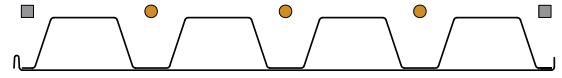

Allowable Diaphragm Shear Strength, q (plf) and Flexibility Factors, F ((in./lb)x10⁶)

DECK GAGE	SIDELAP ATTACHMENT	SPAN (ft-in.)									
		4'-0"	6'-0"	8'-0"	10'-0"	12'-0"	14'-0"	16'-0"	18'-0"	20'-0"	
20/20	VSC2 @ 24"	q	1470	1159	991	891	823	775	739	711	689
		F	8-2R	9.5-2R	10.6-2R	11.4-2R	12-2R	12.5-2R	12.8-2R	13.2-2R	13.4-2R
	VSC2 @ 18"	q	1665	1304	1217	1078	982	978	918	871	879
		F	6.9-2R	8.3-2R	8.5-2R	9.3-2R	10-2R	9.8-1R	10.3-1R	10.7-1R	10.5-1R
	VSC2 @ 12"	q	1847	1573	1426	1334	1272	1228	1194	1167	1094
		F	6-1R	6.7-1R	7.2-1R	7.5-1R	7.7-1R	7.8-1R	7.9-1R	8-1R	8.1-1R
	VSC2 @ 8"	q	2175	1937	1807	1727	1672	1632	1601	1350	1094
		F	5-1R	5.4-1R	5.6-1R	5.8-1R	5.9+0R	5.9+0R	6+0R	6+0R	6.1+0R
	VSC2 @ 6"	q	2457	2253	2141	2071	2023	1988	1709	1350	1094
		F	4.3-1R	4.6+0R	4.7+0R	4.8+0R	4.9+0R	4.9+0R	4.9+0R	5+0R	5+0R
	VSC2 @ 4"	q	2897	2751	2671	2620	2586	2232	1709	1350	1094
		F	3.5+0R	3.7+0R	3.7+0R	3.8+0R	3.8+0R	3.8+0R	3.9+0R	3.9+0R	3.9+0R
20/18	VSC2 @ 24"	q	1789	1465	1293	1186	1115	1064	1026	997	973
		F	5.8-1R	6.5-1R	7-1R	7.3-1R	7.5-1R	7.6-1R	7.7-1R	7.8-1R	7.9-1R
	VSC2 @ 18"	q	2081	1679	1623	1459	1346	1361	1288	1230	1164
		F	4.8-1R	5.5-1R	5.4-1R	5.8-1R	6.1-1R	5.9+0R	6.2+0R	6.4+0R	6.2+0R
	VSC2 @ 12"	q	2347	2074	1928	1837	1775	1730	1696	1437	1164
		F	4.1-1R	4.4+0R	4.5+0R	4.6+0R	4.6+0R	4.7+0R	4.7+0R	4.8+0R	4.8+0R
	VSC2 @ 8"	q	2805	2583	2462	2387	2335	2298	1819	1437	1164
		F	3.3+0R	3.4+0R	3.5+0R	3.6+0R	3.6+0R	3.6+0R	3.6+0R	3.6+0R	3.6+0R
	VSC2 @ 6"	q	3171	2994	2897	2836	2795	2376	1819	1437	1164
		F	2.9+0R	2.9+0R	3+0R	3+0R	3+0R	3+0R	3+0R	3.1+0R	3.1+0R
	VSC2 @ 4"	q	3690	3579	3519	3481	3234	2376	1819	1437	1164
		F	2.4+0R	2.4+0R	2.4+0R	2.4+0R	2.5+0R	2.5+0R	2.5+0R	2.5+0R	2.5+0R
18/20	VSC2 @ 24"	q	1550	1215	1033	924	851	799	760	730	706
		F	7.3-2R	8.8-2R	9.9-2R	10.7-2R	11.4-2R	11.9-2R	12.3-2R	12.6-2R	12.9-2R
	VSC2 @ 18"	q	1744	1359	1260	1112	1011	1003	940	890	897
		F	6.3-2R	7.8-2R	8-2R	8.8-2R	9.5-2R	9.4-1R	9.9-1R	10.3-1R	10.2-1R
	VSC2 @ 12"	q	1928	1630	1470	1371	1303	1254	1217	1189	1165
		F	5.6-1R	6.3-1R	6.8-1R	7.1-1R	7.3-1R	7.5-1R	7.6-1R	7.7-1R	7.8-1R
	VSC2 @ 8"	q	2261	1999	1857	1768	1708	1664	1630	1604	1582
		F	4.7-1R	5.1-1R	5.3-1R	5.5-1R	5.6+0R	5.7+0R	5.8+0R	5.8+0R	5.9+0R
	VSC2 @ 6"	q	2549	2322	2199	2121	2068	2029	2000	1953	1582
		F	4.1-1R	4.3+0R	4.5+0R	4.6+0R	4.6+0R	4.7+0R	4.7+0R	4.8+0R	4.8+0R
	VSC2 @ 4"	q	3006	2841	2750	2693	2653	2624	2471	1953	1582
		F	3.3+0R	3.5+0R	3.5+0R	3.6+0R	3.6+0R	3.6+0R	3.7+0R	3.7+0R	3.7+0R
18/18	VSC2 @ 24"	q	1789	1465	1293	1186	1115	1064	1026	997	973
		F	5.4-1R	6.2-1R	6.6-1R	6.9-1R	7.2-1R	7.4-1R	7.5-1R	7.6-1R	7.7-1R
	VSC2 @ 18"	q	2081	1679	1623	1459	1346	1361	1288	1230	1253
		F	4.5-1R	5.3-1R	5.2-1R	5.6-1R	5.9-1R	5.7+0R	6+0R	6.2+0R	6+0R
	VSC2 @ 12"	q	2347	2074	1928	1837	1775	1730	1696	1669	1648
		F	3.9-1R	4.1+0R	4.3+0R	4.4+0R	4.5+0R	4.5+0R	4.6+0R	4.6+0R	4.6+0R
	VSC2 @ 8"	q	2805	2583	2462	2387	2335	2298	2269	2083	1687
		F	3.1+0R	3.3+0R	3.4+0R	3.4+0R	3.4+0R	3.5+0R	3.5+0R	3.5+0R	3.5+0R
	VSC2 @ 6"	q	3171	2994	2897	2836	2795	2764	2636	2083	1687
		F	2.7+0R	2.8+0R	2.8+0R	2.9+0R	2.9+0R	2.9+0R	2.9+0R	2.9+0R	2.9+0R
	VSC2 @ 4"	q	3690	3579	3519	3481	3455	3436	2636	2083	1687
		F	2.2+0R	2.3+0R	2.3+0R	2.3+0R	2.3+0R	2.3+0R	2.3+0R	2.3+0R	2.3+0R

See footnotes on page 127.

Type PLN3™ -CD

- 32/5 Weld Pattern at Supports
- Sidelaps Connected with PunchLok II Tool

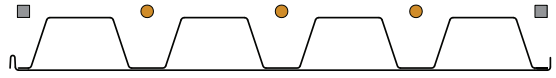

Allowable Diaphragm Shear Strength, q (plf) and Flexibility Factors, F ((in./lb)x10⁶)

DECK GAGE	SIDELAP ATTACHMENT	SPAN (ft-in.)									
		4'-0"	6'-0"	8'-0"	10'-0"	12'-0"	14'-0"	16'-0"	18'-0"	20'-0"	
18/16	VSC2 @ 24"	q	2029	1713	1546	1443	1374	1324	1286	1256	1232
		F	4.9-1R	5.4-1R	5.8-1R	6-1R	6.2-1R	6.3-1R	6.4-1R	6.5-1R	6.6-1R
	VSC2 @ 18"	q	2413	1995	1977	1799	1675	1712	1629	1564	1601
		F	3.9-1R	4.6-1R	4.5+0R	4.8+0R	5.1+0R	4.9+0R	5.1+0R	5.3+0R	5.1+0R
	VSC2 @ 12"	q	2753	2501	2366	2282	2225	2184	2152	2128	1773
		F	3.4+0R	3.6+0R	3.7+0R	3.8+0R	3.8+0R	3.9+0R	3.9+0R	3.9+0R	3.9+0R
	VSC2 @ 8"	q	3310	3118	3015	2950	2906	2873	2771	2189	1773
		F	2.7+0R	2.8+0R	2.9+0R	2.9+0R	2.9+0R	3+0R	3+0R	3+0R	3+0R
	VSC2 @ 6"	q	3727	3584	3507	3458	3425	3401	2771	2189	1773
		F	2.3+0R	2.4+0R	2.4+0R	2.5+0R	2.5+0R	2.5+0R	2.5+0R	2.5+0R	2.5+0R
	VSC2 @ 4"	q	4270	4190	4147	4120	4101	3619	2771	2189	1773
		F	1.9+0R	2+0R	2+0R	2+0R	2+0R	2+0R	2+0R	2+0R	2+0R
16/18	VSC2 @ 24"	q	1789	1465	1293	1186	1115	1064	1026	997	973
		F	5.1-1R	5.9-1R	6.4-1R	6.7-1R	6.9-1R	7.1-1R	7.3-1R	7.4-1R	7.5-1R
	VSC2 @ 18"	q	2081	1679	1623	1459	1346	1361	1288	1230	1253
		F	4.3-1R	5-1R	5-1R	5.4-1R	5.7-1R	5.6-1R	5.8-1R	6-1R	5.8+0R
	VSC2 @ 12"	q	2347	2074	1928	1837	1775	1730	1696	1669	1648
		F	3.7-1R	4+0R	4.1+0R	4.3+0R	4.3+0R	4.4+0R	4.4+0R	4.5+0R	4.5+0R
	VSC2 @ 8"	q	2805	2583	2462	2387	2335	2298	2269	2247	2229
		F	3+0R	3.1+0R	3.2+0R	3.3+0R	3.3+0R	3.3+0R	3.4+0R	3.4+0R	3.4+0R
	VSC2 @ 6"	q	3171	2994	2897	2836	2795	2764	2741	2723	2251
		F	2.6+0R	2.7+0R	2.7+0R	2.8+0R	2.8+0R	2.8+0R	2.8+0R	2.8+0R	2.8+0R
	VSC2 @ 4"	q	3690	3579	3519	3481	3455	3436	3421	2779	2251
		F	2.1+0R	2.2+0R	2.2+0R	2.2+0R	2.2+0R	2.2+0R	2.2+0R	2.2+0R	2.2+0R
16/16	VSC2 @ 24"	q	2029	1713	1546	1443	1374	1324	1286	1256	1232
		F	4.6-1R	5.2-1R	5.6-1R	5.8-1R	6-1R	6.2-1R	6.3-1R	6.4-1R	6.4-1R
	VSC2 @ 18"	q	2413	1995	1977	1799	1675	1712	1629	1564	1601
		F	3.8-1R	4.4-1R	4.3-1R	4.7-1R	4.9+0R	4.8+0R	5+0R	5.1+0R	5+0R
	VSC2 @ 12"	q	2753	2501	2366	2282	2225	2184	2152	2128	2108
		F	3.2+0R	3.5+0R	3.6+0R	3.7+0R	3.7+0R	3.8+0R	3.8+0R	3.8+0R	3.8+0R
	VSC2 @ 8"	q	3310	3118	3015	2950	2906	2873	2849	2830	2369
		F	2.6+0R	2.7+0R	2.8+0R	2.8+0R	2.8+0R	2.9+0R	2.9+0R	2.9+0R	2.9+0R
	VSC2 @ 6"	q	3727	3584	3507	3458	3425	3401	3382	2925	2369
		F	2.2+0R	2.3+0R	2.3+0R	2.4+0R	2.4+0R	2.4+0R	2.4+0R	2.4+0R	2.4+0R
	VSC2 @ 4"	q	4270	4190	4147	4120	4101	4088	3702	2925	2369
		F	1.8+0R	1.9+0R	1.9+0R	1.9+0R	1.9+0R	1.9+0R	1.9+0R	1.9+0R	1.9+0R

See footnotes on page 127.

Type PLN™ -24-CD

- 24/4 Weld Pattern at Supports
- Sidelaps Connected with PunchLok II Tool

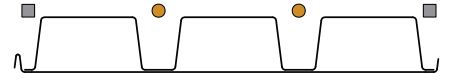

Allowable Diaphragm Shear Strength, q (plf) and Flexibility Factors, F ((in./lb)x10⁶)

DECK GAGE	SIDELAP ATTACHMENT	SPAN (ft-in.)									
		4'-0"	6'-0"	8'-0"	10'-0"	12'-0"	14'-0"	16'-0"	18'-0"	20'-0"	
20/20	VSC2 @ 24"	q	1350	1063	919	833	775	734	703	679	660
		F	10.9-3R	12.9-3R	14.3-3R	15.3-3R	16.1-3R	16.7-3R	17.1-3R	17.5-2R	17.8-2R
	VSC2 @ 18"	q	1552	1221	1154	1026	937	940	884	841	852
		F	9.1-2R	11.1-2R	11.2-2R	12.3-2R	13.2-2R	12.9-2R	13.6-2R	14.1-2R	13.8-1R
	VSC2 @ 12"	q	1742	1496	1366	1286	1231	1192	1162	1139	1120
		F	7.9-2R	8.8-1R	9.3-1R	9.7-1R	9.9-1R	10.1-1R	10.3-1R	10.4-1R	10.5-1R
	VSC2 @ 8"	q	2086	1871	1756	1685	1636	1601	1574	1466	1187
		F	6.4-1R	6.9-1R	7.1-1R	7.3-1R	7.4-1R	7.5+0R	7.6+0R	7.7+0R	7.7+0R
	VSC2 @ 6"	q	2383	2198	2098	2036	1994	1963	1855	1466	1187
		F	5.4-1R	5.7-1R	5.9+0R	6+0R	6.1+0R	6.1+0R	6.2+0R	6.2+0R	6.2+0R
	VSC2 @ 4"	q	2850	2717	2645	2600	2569	2423	1855	1466	1187
		F	4.3+0R	4.5+0R	4.6+0R	4.6+0R	4.7+0R	4.7+0R	4.7+0R	4.7+0R	4.7+0R
20/18	VSC2 @ 24"	q	1668	1366	1215	1124	1063	1020	987	962	942
		F	7.7-2R	8.6-1R	9.1-1R	9.5-1R	9.7-1R	9.9-1R	10.1-1R	10.2-1R	10.3-1R
	VSC2 @ 18"	q	1973	1597	1561	1408	1303	1324	1255	1201	1227
		F	6.1-1R	7.2-1R	6.9-1R	7.5-1R	7.9-1R	7.6-1R	7.9-1R	8.2-1R	7.9+0R
	VSC2 @ 12"	q	2254	2006	1875	1794	1739	1699	1669	1573	1274
		F	5.2-1R	5.5-1R	5.7+0R	5.8+0R	5.9+0R	5.9+0R	6+0R	6+0R	6+0R
	VSC2 @ 8"	q	2742	2538	2428	2361	2314	2281	1990	1573	1274
		F	4.1+0R	4.3+0R	4.3+0R	4.4+0R	4.4+0R	4.4+0R	4.5+0R	4.5+0R	4.5+0R
	VSC2 @ 6"	q	3138	2973	2884	2829	2791	2599	1990	1573	1274
		F	3.5+0R	3.6+0R	3.6+0R	3.6+0R	3.7+0R	3.7+0R	3.7+0R	3.7+0R	3.7+0R
	VSC2 @ 4"	q	3705	3601	3544	3509	3485	2599	1990	1573	1274
		F	2.8+0R	2.8+0R	2.9+0R	2.9+0R	2.9+0R	2.9+0R	2.9+0R	2.9+0R	2.9+0R
18/20	VSC2 @ 24"	q	1419	1111	955	862	799	755	721	695	674
		F	10-3R	12-3R	13.5-3R	14.5-3R	15.3-3R	15.9-3R	16.4-3R	16.9-3R	17.2-3R
	VSC2 @ 18"	q	1621	1268	1191	1055	962	961	903	858	867
		F	8.5-2R	10.4-2R	10.7-2R	11.8-2R	12.7-2R	12.5-2R	13.1-2R	13.7-2R	13.4-2R
	VSC2 @ 12"	q	1812	1545	1404	1317	1258	1215	1183	1158	1137
		F	7.4-2R	8.3-2R	8.9-1R	9.3-1R	9.6-1R	9.8-1R	10-1R	10.1-1R	10.2-1R
	VSC2 @ 8"	q	2160	1924	1798	1720	1667	1628	1599	1576	1558
		F	6-1R	6.5-1R	6.8-1R	7-1R	7.2-1R	7.3-1R	7.4-1R	7.4+0R	7.5+0R
	VSC2 @ 6"	q	2462	2258	2148	2079	2032	1998	1972	1952	1702
		F	5.1-1R	5.5-1R	5.7+0R	5.8+0R	5.9+0R	5.9+0R	6+0R	6+0R	6+0R
	VSC2 @ 4"	q	2943	2794	2713	2662	2627	2602	2582	2101	1702
		F	4.1+0R	4.3+0R	4.4+0R	4.4+0R	4.5+0R	4.5+0R	4.5+0R	4.5+0R	4.5+0R
18/18	VSC2 @ 24"	q	1668	1366	1215	1124	1063	1020	987	962	942
		F	7.2-2R	8.2-2R	8.7-1R	9.1-1R	9.4-1R	9.6-1R	9.8-1R	9.9-1R	10.1-1R
	VSC2 @ 18"	q	1973	1597	1561	1408	1303	1324	1255	1201	1227
		F	5.8-1R	6.8-1R	6.7-1R	7.2-1R	7.6-1R	7.4-1R	7.7-1R	8-1R	7.7+0R
	VSC2 @ 12"	q	2254	2006	1875	1794	1739	1699	1669	1645	1627
		F	4.9-1R	5.3-1R	5.5-1R	5.6+0R	5.7+0R	5.8+0R	5.8+0R	5.8+0R	5.9+0R
	VSC2 @ 8"	q	2742	2538	2428	2361	2314	2281	2255	2235	1831
		F	3.9+0R	4.1+0R	4.2+0R	4.2+0R	4.3+0R	4.3+0R	4.3+0R	4.3+0R	4.4+0R
	VSC2 @ 6"	q	3138	2973	2884	2829	2791	2764	2743	2260	1831
		F	3.3+0R	3.4+0R	3.5+0R	3.5+0R	3.5+0R	3.6+0R	3.6+0R	3.6+0R	3.6+0R
	VSC2 @ 4"	q	3705	3601	3544	3509	3485	3468	2860	2260	1831
		F	2.7+0R	2.7+0R	2.7+0R	2.8+0R	2.8+0R	2.8+0R	2.8+0R	2.8+0R	2.8+0R

See footnotes on page 127.

Type PLN™ -24-CD

- 24/4 Weld Pattern at Supports
- Sidelaps Connected with PunchLok II Tool

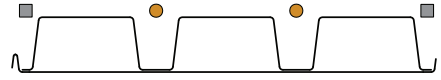

Allowable Diaphragm Shear Strength, q (plf) and Flexibility Factors, F ((in./lb)x10⁶)

DECK GAGE	SIDELAP ATTACHMENT	SPAN (ft-in.)									
		4'-0"	6'-0"	8'-0"	10'-0"	12'-0"	14'-0"	16'-0"	18'-0"	20'-0"	
18/16	VSC2 @ 24"	q	1917	1623	1476	1388	1329	1287	1254	1228	1207
		F	6.4-1R	7.2-1R	7.6-1R	7.9-1R	8.1-1R	8.3-1R	8.4-1R	8.5-1R	8.6-1R
	VSC2 @ 18"	q	2324	1924	1927	1756	1639	1682	1603	1540	1581
		F	5.1-1R	6-1R	5.7-1R	6.2-1R	6.6-1R	6.3+0R	6.6+0R	6.8+0R	6.6+0R
	VSC2 @ 12"	q	2688	2456	2332	2257	2205	2168	2140	2118	1937
		F	4.3-1R	4.6+0R	4.7+0R	4.8+0R	4.9+0R	4.9+0R	4.9+0R	5+0R	5+0R
	VSC2 @ 8"	q	3297	3116	3019	2959	2918	2889	2866	2391	1937
		F	3.4+0R	3.5+0R	3.6+0R	3.6+0R	3.6+0R	3.7+0R	3.7+0R	3.7+0R	3.7+0R
	VSC2 @ 6"	q	3762	3624	3551	3505	3474	3451	3026	2391	1937
		F	2.8+0R	2.9+0R	3+0R	3+0R	3+0R	3+0R	3+0R	3+0R	3+0R
	VSC2 @ 4"	q	4380	4301	4259	4233	4215	3953	3026	2391	1937
		F	2.3+0R	2.3+0R	2.3+0R	2.3+0R	2.4+0R	2.4+0R	2.4+0R	2.4+0R	2.4+0R
16/18	VSC2 @ 24"	q	1668	1366	1215	1124	1063	1020	987	962	942
		F	6.9-2R	7.8-2R	8.4-1R	8.9-1R	9.2-1R	9.4-1R	9.6-1R	9.7-1R	9.8-1R
	VSC2 @ 18"	q	1973	1597	1561	1408	1303	1324	1255	1201	1227
		F	5.6-1R	6.6-1R	6.5-1R	7-1R	7.4-1R	7.2-1R	7.5-1R	7.8-1R	7.6-1R
	VSC2 @ 12"	q	2254	2006	1875	1794	1739	1699	1669	1645	1627
		F	4.7-1R	5.1-1R	5.3-1R	5.4+0R	5.5+0R	5.6+0R	5.7+0R	5.7+0R	5.7+0R
	VSC2 @ 8"	q	2742	2538	2428	2361	2314	2281	2255	2235	2219
		F	3.8+0R	3.9+0R	4+0R	4.1+0R	4.2+0R	4.2+0R	4.2+0R	4.2+0R	4.2+0R
	VSC2 @ 6"	q	3138	2973	2884	2829	2791	2764	2743	2727	2427
		F	3.2+0R	3.3+0R	3.4+0R	3.4+0R	3.4+0R	3.4+0R	3.5+0R	3.5+0R	3.5+0R
	VSC2 @ 4"	q	3705	3601	3544	3509	3485	3468	3454	2996	2427
		F	2.5+0R	2.6+0R	2.6+0R	2.6+0R	2.7+0R	2.7+0R	2.7+0R	2.7+0R	2.7+0R
16/16	VSC2 @ 24"	q	1917	1623	1476	1388	1329	1287	1254	1228	1207
		F	6.1-1R	6.9-1R	7.4-1R	7.7-1R	7.9-1R	8.1-1R	8.2-1R	8.3-1R	8.4-1R
	VSC2 @ 18"	q	2324	1924	1927	1756	1639	1682	1603	1540	1581
		F	4.9-1R	5.8-1R	5.6-1R	6-1R	6.4-1R	6.2+0R	6.4+0R	6.6+0R	6.4+0R
	VSC2 @ 12"	q	2688	2456	2332	2257	2205	2168	2140	2118	2100
		F	4.1-1R	4.4+0R	4.6+0R	4.7+0R	4.7+0R	4.8+0R	4.8+0R	4.9+0R	4.9+0R
	VSC2 @ 8"	q	3297	3116	3019	2959	2918	2889	2866	2849	2571
		F	3.3+0R	3.4+0R	3.5+0R	3.5+0R	3.5+0R	3.6+0R	3.6+0R	3.6+0R	3.6+0R
	VSC2 @ 6"	q	3762	3624	3551	3505	3474	3451	3434	3174	2571
		F	2.7+0R	2.8+0R	2.9+0R	2.9+0R	2.9+0R	2.9+0R	2.9+0R	3+0R	3+0R
	VSC2 @ 4"	q	4380	4301	4259	4233	4215	4202	4018	3174	2571
		F	2.2+0R	2.2+0R	2.3+0R	2.3+0R	2.3+0R	2.3+0R	2.3+0R	2.3+0R	2.3+0R

See footnotes on page 127.



Shallow VERCOR™ Deck



Deep VERCOR™ Deck

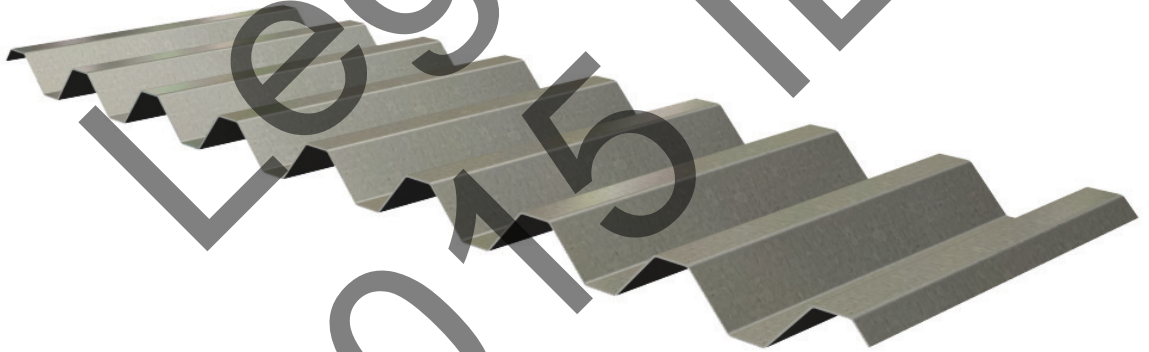

Deep VERCOR™ Deck (Inverted)

VERCOR™ DECK CONTENTS

Section Properties	144-145
Vertical Load Capacity	147-148
Shallow VERCOR™ Deck Allowable Diaphragm Shear Strength and Flexibility Tables .	149-152
Deep VERCOR™ Deck Allowable Diaphragm Shear Strength and Flexibility Tables . . .	153-154

Shallow VERCOR™ Deck

- 9/16" Deep Deck
- Galvanized



Dimensions

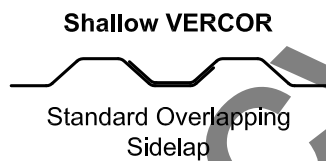
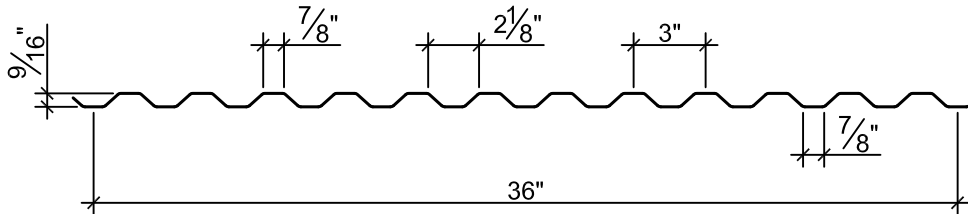

Deck Weight and Section Properties

Gage	Weight Galv (psf)	I _d for Deflection		Moment		Allowable Reactions per ft of Width (lb)							
		Single Span (in. ⁴ /ft)	Multi Span (in. ⁴ /ft)	+S _{eff} (in. ³ /ft)	-S _{eff} (in. ³ /ft)	One Flange Loading				Two Flange Loading			
						End Bearing Length		Interior Bearing Length		End Bearing Length		Interior Bearing Length	
						1 1/2"	2"	1 1/2"	2"	1 1/2"	2"	1 1/2"	2"
26	1.0	0.013	0.013	0.041	0.043	581	644	788	862	536	582	963	1061
24	1.3	0.018	0.018	0.059	0.059	980	1081	1375	1497	999	1080	1709	1875
22	1.6	0.022	0.022	0.073	0.073	1466	1611	2105	2283	1598	1721	2645	2889

1. Section properties are based on $F_y = 60,000$ psi (specified minimum $F_y = 80,000$ psi).
2. I_d is for deflection due to uniform loads.
3. S_{eff} (+ or -) is the effective section modulus.
4. Allowable (ASD) reactions are based on web crippling, per AISI S100 Section C3.4, where $\Omega_w = 1.70$ for end bearing and 1.75 for interior bearing. Nominal reactions may be determined by multiplying the table values by Ω_w . LRFSD reactions may be determined by multiplying nominal reactions by $\Phi_w = 0.90$ for end reactions and 0.85 for interior reactions.

Attachment Patterns to Supports

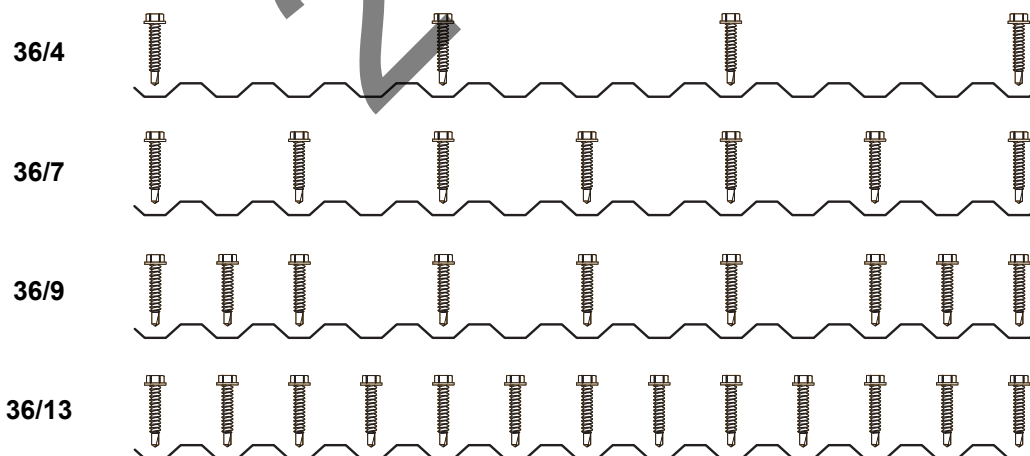

Deep VERCOR™ Deck

- 1⁵/₁₆" Deep Deck
- Galvanized



Dimensions

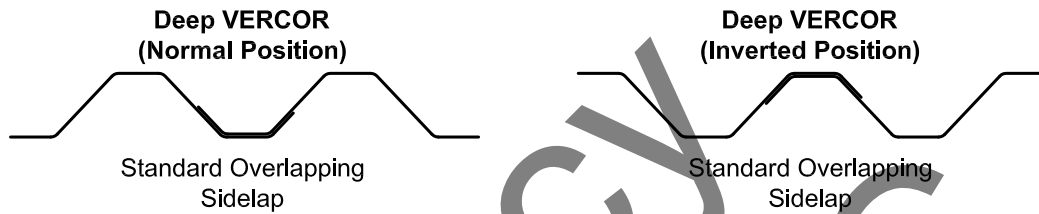
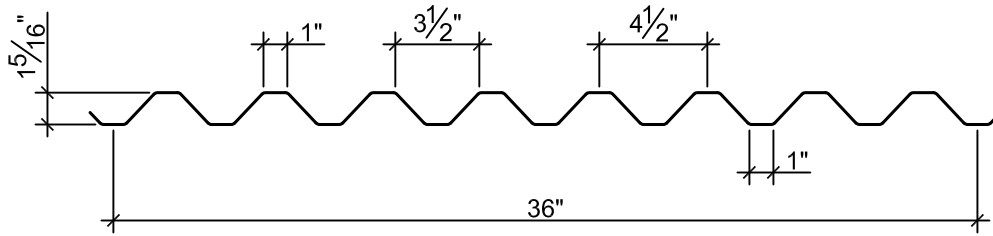

Deck Weight and Section Properties

Gage	Weight Galv (psf)	I_d for Deflection		Moment		Allowable Reactions per ft of Width (lb)									
		Single Span (in. ⁴ /ft)	Multi Span (in. ⁴ /ft)	+ S_{eff} (in. ³ /ft)	- S_{eff} (in. ³ /ft)	One Flange Loading				Two Flange Loading					
						End Bearing Length		Interior Bearing Length		End Bearing Length		Interior Bearing Length			
26	1.1	0.075	0.075	0.099	0.103	2"	3"	4"	3"	4"	2"	3"	4"	3"	4"
24	1.4	0.097	0.097	0.137	0.138	802	927	1032	1366	1503	762	857	937	1642	1819
22	1.7	0.120	0.120	0.172	0.171	1184	1361	1510	2029	2225	1208	1351	1472	2479	2737
20	2.1	0.143	0.143	0.204	0.204	1628	1864	2064	2807	3069	1751	1950	2118	3467	3817

Notes:

1. Section properties are based on $F_y = 60,000$ psi (specified minimum $F_y = 80,000$ psi).
2. I_d is for deflection due to uniform loads.
3. S_{eff} (+ or -) is the effective section modulus.
4. Allowable (ASD) reactions are based on web crippling, per AISI S100 Section C3.4, where $\Omega_w = 1.70$ for end bearing and 1.75 for interior bearing. Nominal reactions may be determined by multiplying the table values by Ω_w . LRFD reactions may be determined by multiplying nominal reactions by $\Phi_w = 0.90$ for end reactions and 0.85 for interior reactions.

Attachment Patterns to Supports

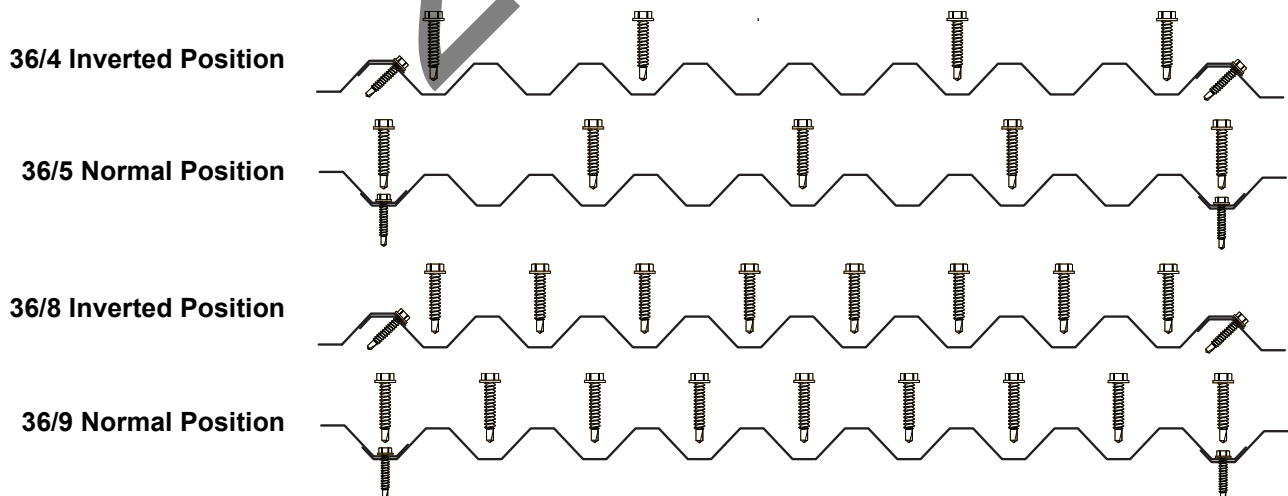

Footnotes for Allowable Uniform Load Tables

1. Stress = Allowable uniform load based on maximum allowable flexural stress in deck.
2. L/360, L/240 or L/180 = Uniform load which produces selected deflection in deck.
3. The symbol ♦♦ indicates allowable uniform load based on deflection exceeds allowable uniform load based on stress.
4. Nominal uniform loads governed by stress may be determined by multiplying the allowable values in the table by $\Omega_b = 1.67$. LRFD loads may be determined by multiplying nominal loads by $\Phi_b = 0.95$.

Footnotes for Diaphragm Shear Strength and Flexibility Factor Tables

General Notes

1. #10 = #10 Generic Screw. Sidelap connections are not required at support locations.
2. The dimension from the first and last sidelap connection within each span is to be no more than one-half of specified spacing.
3. R is the ratio of vertical span (L_V) of the deck to the length (L_S) of the deck sheet: $R = L_V / L_S$.
4. Interpolation of diaphragm shear strength between adjacent spans or sidelap spacings is permissible. For interpolation of the diaphragm flexibility factor between adjacent spans, use the flexibility factor for the closest adjacent span length.
5. Diaphragm shear values for side seam fasteners placed at spacings other than those in the table should be determined based on the number of fasteners in each span.
6. The allowable diaphragm shear values in the tables utilize a factor of safety, $\Omega = 2.5$ (limited by connections) with the exception of the gray shaded table values, which utilize a factor of safety of $\Omega = 2.0$ (limited by panel buckling).
7. Deck is attached with minimum #12 Screws (self drilling, self tapping) to supports. Select appropriate screw based on actual substrate thickness. This table is provided as a guide, proper selection should be verified based on the specific fasteners used.

Support Thickness	Fastener Designation
33 mil (0.0346") to 3/16"	#3 Drill Point
1/8" to 1/4"	#4 Drill Point
1/8" to 1/2"	#5 Drill Point

8. All tabulated diaphragm values shown in this section are for a minimum 0.0385 in. thick support with SDI recognized screws produced by Buildex, Elco, Hilti or Simpson Strong-Tie. If the minimum support thickness can not be met or a screw that is not recognized by SDI is used, modify tabulated q and F values based on actual substrate and thickness using Adjustment Factors listed in the following tables.

For 9/16" (Shallow) VERCOR:

Deck Gage	Factors	Substrate Thickness and Strength									
		20 ga		18 ga		16 ga		14 ga		≥ 12 ga	
		33 mil (0.0345 in) 33 ksi	50 ksi	43 mil (0.0451 in) 33 ksi	50 ksi	54 mil (0.0566 in) 33 ksi	50 ksi	68 mil (0.0713 in) 33 ksi	50 ksi	≥ 97 mil (0.1017 in) 33 ksi	50 ksi
26	R_q	0.66	0.69	0.69	0.69	0.69	0.69	0.69	0.69	0.69	0.69
	R_F	1.26	1.00	1.00	1.00	1.00	1.00	1.00	1.00	1.00	1.00
24	R_q	0.52	0.66	0.68	0.69	0.69	0.69	0.69	0.69	0.69	0.69
	R_F	1.51	1.38	1.27	1.00	1.00	1.00	1.00	1.00	1.00	1.00
22	R_q	0.38	0.54	0.59	0.69	0.69	0.69	0.69	0.69	0.69	0.69
	R_F	1.69	1.58	1.36	1.00	1.00	1.00	1.00	1.00	1.00	1.00

For 1-5/16" (Deep) VERCOR:

Deck Gage	Factors	Substrate Thickness and Strength									
		20 ga		18 ga		16 ga		14 ga		≥ 12 ga	
		33 mil (0.0345 in) 33 ksi	50 ksi	43 mil (0.0451 in) 33 ksi	50 ksi	54 mil (0.0566 in) 33 ksi	50 ksi	68 mil (0.0713 in) 33 ksi	50 ksi	≥ 97 mil (0.1017 in) 33 ksi	50 ksi
26	R_q	0.69	0.74	0.74	0.74	0.74	0.74	0.74	0.74	0.74	0.74
	R_F	1.13	1.00	1.00	1.00	1.00	1.00	1.00	1.00	1.00	1.00
24	R_q	0.58	0.70	0.73	0.75	0.75	0.75	0.75	0.75	0.75	0.75
	R_F	1.21	1.17	1.13	1.00	1.00	1.00	1.00	1.00	1.00	1.00
22	R_q	0.48	0.61	0.65	0.75	0.75	0.75	0.75	0.75	0.75	0.75
	R_F	1.27	1.24	1.16	1.00	1.00	1.00	1.00	1.00	1.00	1.00
20	R_q	0.39	0.53	0.57	0.71	0.71	0.76	0.76	0.76	0.76	0.76
	R_F	1.32	1.33	1.25	1.21	1.16	1.00	1.00	1.00	1.00	1.00

9. Adjustment factors are based on connection strengths determined in accordance with Section E4 of AISI S100. These self drilling, self tapping screws must be compliant with ASTM C1315.
10. Allowable Diaphragm Strength = $q \cdot R_q$; Flexibility Factor = $F \cdot R_F$.
11. These adjustment factors are based on the maximum adjustment for the tabulated span lengths and fastener patterns. To calculate a specific condition, use design equations listed at the end of Evaluation Report ER-0217.



Allowable Uniform Loads (psf)

SPAN	DECK		SPAN (ft-in.)											
	GAGE	CRITERIA	1'-0"	1'-6"	2'-0"	2'-6"	3'-0"	3'-6"	4'-0"	4'-6"	5'-0"	5'-6"	6'-0"	
SINGLE	26	Stress	300	300	246	157	109	80	62	49	39	33	27	
		L/360	◆◆◆	169	71	36	21	13	9	6	5	3	3	
		L/240	◆◆◆	253	107	55	32	20	13	9	7	5	4	
	24	L/180	◆◆◆	◆◆◆	142	73	42	27	18	12	9	7	5	
		Stress	300	300	300	227	157	116	89	70	57	47	39	
		L/360	◆◆◆	233	98	50	29	18	12	9	6	5	4	
	22	L/240	◆◆◆	◆◆◆	148	76	44	28	18	13	9	7	5	
		L/180	◆◆◆	◆◆◆	197	101	58	37	25	17	13	9	7	
		Stress	300	300	300	280	195	143	110	87	70	58	49	
	DOUBLE	26	L/360	◆◆◆	◆◆◆	171	88	51	32	21	15	11	8	6
			L/240	◆◆◆	◆◆◆	257	132	76	48	32	23	16	12	10
			L/180	◆◆◆	◆◆◆	◆◆◆	◆◆◆	101	64	43	30	22	16	13
24		Stress	300	300	300	227	157	116	89	70	57	47	39	
		L/360	◆◆◆	◆◆◆	237	121	70	44	30	21	15	11	9	
		L/240	◆◆◆	◆◆◆	◆◆◆	182	105	66	44	31	23	17	13	
22		L/180	◆◆◆	◆◆◆	◆◆◆	◆◆◆	141	88	59	42	30	23	18	
		Stress	300	300	300	280	195	143	110	87	70	58	49	
		L/360	◆◆◆	◆◆◆	290	148	86	54	36	25	19	14	11	
TRIPLE		26	L/240	◆◆◆	◆◆◆	◆◆◆	◆◆◆	172	108	72	51	37	28	21
			L/180	◆◆◆	◆◆◆	◆◆◆	◆◆◆	172	108	72	51	37	28	21
			Stress	300	300	300	206	143	105	81	64	52	43	36
	24	L/360	◆◆◆	◆◆◆	134	69	40	25	17	12	9	6	5	
		L/240	◆◆◆	◆◆◆	201	103	60	38	25	18	13	10	7	
		L/180	◆◆◆	◆◆◆	268	137	79	50	34	24	17	13	10	
	22	Stress	300	300	300	283	197	144	111	87	71	59	49	
		L/360	◆◆◆	◆◆◆	186	95	55	35	23	16	12	9	7	
		L/240	◆◆◆	◆◆◆	278	143	82	52	35	24	18	13	10	
	22	L/180	◆◆◆	◆◆◆	◆◆◆	190	110	69	46	33	24	18	14	
		Stress	300	300	300	300	243	179	137	108	88	72	61	
		L/360	◆◆◆	◆◆◆	227	116	67	42	28	20	15	11	8	
22	L/240	◆◆◆	◆◆◆	◆◆◆	174	101	63	43	30	22	16	13		
	L/180	◆◆◆	◆◆◆	◆◆◆	232	134	85	57	40	29	22	17		

See footnotes on page 146.



Allowable Uniform Loads (psf)

	DECK	SPAN GAGE	CRITERIA	SPAN (ft.-in.)													
				3'-0"	3'-6"	4'-0"	4'-6"	5'-0"	5'-6"	6'-0"	6'-6"	7'-0"	7'-6"	8'-0"	8'-6"	9'-0"	9'-6"
SINGLE	26	Stress	264	194	149	117	95	79	66	56	48	42	37	33	29	26	24
		L/360	122	77	51	36	26	20	15	12	10	8	6	5	5	4	3
		L/240	182	115	77	54	39	30	23	18	14	12	10	8	7	6	5
	24	L/180	243	153	103	72	53	39	30	24	19	16	13	11	9	8	7
		Stress	300	268	206	162	132	109	91	78	67	58	51	46	41	36	33
		L/360	157	99	66	47	34	26	20	15	12	10	8	7	6	5	4
	22	L/240	236	149	100	70	51	38	29	23	19	15	12	10	9	7	6
		L/180	◆◆◆	198	133	93	68	51	39	31	25	20	17	14	12	10	8
		Stress	300	300	258	204	165	136	115	98	84	73	65	57	51	46	41
	20	L/360	195	123	82	58	42	32	24	19	15	12	10	9	7	6	5
		L/240	292	184	123	86	63	47	36	29	23	19	15	13	11	9	8
		L/180	◆◆◆	245	164	115	84	63	49	38	31	25	21	17	14	12	11
26	Stress	300	300	300	242	196	162	136	116	100	87	77	68	60	54	49	
	L/360	232	146	98	69	50	38	29	23	18	15	12	10	9	7	6	
	L/240	◆◆◆	219	147	103	75	56	43	34	27	22	18	15	13	11	9	
24	L/180	◆◆◆	292	196	137	100	75	58	46	36	30	24	20	17	15	13	
	Stress	275	202	155	122	99	82	69	59	50	44	39	34	31	27	25	
	L/360	◆◆◆	184	123	87	63	48	37	29	23	19	15	13	11	9	8	
22	L/240	◆◆◆	◆◆◆	◆◆◆	◆◆◆	95	71	55	43	35	28	23	19	16	14	12	
	L/180	◆◆◆	◆◆◆	◆◆◆	◆◆◆	◆◆◆	◆◆◆	◆◆◆	58	46	37	31	26	22	18	16	
	Stress	300	270	207	164	132	109	92	78	68	59	52	46	41	37	33	
20	L/360	◆◆◆	238	160	112	82	61	47	37	30	24	20	17	14	12	10	
	L/240	◆◆◆	◆◆◆	◆◆◆	◆◆◆	123	92	71	56	45	36	30	25	21	18	15	
	L/180	◆◆◆	◆◆◆	◆◆◆	◆◆◆	◆◆◆	◆◆◆	◆◆◆	74	60	48	40	33	28	24	20	
26	Stress	300	300	257	203	164	136	114	97	84	73	64	57	51	45	41	
	L/360	◆◆◆	295	198	139	101	76	59	46	37	30	25	21	17	15	13	
	L/240	◆◆◆	◆◆◆	◆◆◆	◆◆◆	152	114	88	69	55	45	37	31	26	22	19	
24	L/180	◆◆◆	◆◆◆	◆◆◆	◆◆◆	◆◆◆	◆◆◆	◆◆◆	92	74	60	49	41	35	29	25	
	Stress	300	300	300	242	196	162	136	116	100	87	77	68	60	54	49	
	L/360	◆◆◆	◆◆◆	235	165	121	91	70	55	44	36	29	25	21	18	15	
22	L/240	◆◆◆	◆◆◆	◆◆◆	◆◆◆	181	136	105	82	66	54	44	37	31	26	23	
	L/180	◆◆◆	◆◆◆	◆◆◆	◆◆◆	◆◆◆	◆◆◆	◆◆◆	110	88	71	59	49	41	35	30	
	Stress	300	252	193	153	124	102	86	73	63	55	48	43	38	34	31	
20	L/360	229	144	97	68	49	37	29	23	18	15	12	10	8	7	6	
	L/240	◆◆◆	216	145	102	74	56	43	34	27	22	18	15	13	11	9	
	L/180	◆◆◆	◆◆◆	◆◆◆	136	99	74	57	45	36	29	24	20	17	14	12	
26	Stress	300	300	259	204	166	137	115	98	84	74	65	57	51	46	41	
	L/360	296	187	125	88	64	48	37	29	23	19	16	13	11	9	8	
	L/240	◆◆◆	280	187	132	96	72	56	44	35	28	23	20	16	14	12	
24	L/180	◆◆◆	◆◆◆	250	176	128	96	74	58	47	38	31	26	22	19	16	
	Stress	300	300	300	253	205	170	143	121	105	91	80	71	63	57	51	
	L/360	◆◆◆	231	155	109	79	59	46	36	29	23	19	16	14	12	10	
22	L/240	◆◆◆	◆◆◆	232	163	119	89	69	54	43	35	29	24	20	17	15	
	L/180	◆◆◆	◆◆◆	◆◆◆	217	158	119	92	72	58	47	39	32	27	23	20	
	Stress	300	300	300	245	202	170	145	125	109	96	85	76	68	61		
20	L/360	◆◆◆	275	184	129	94	71	55	43	34	28	23	19	16	14	12	
	L/240	◆◆◆	◆◆◆	276	194	142	106	82	64	52	42	35	29	24	21	18	
	L/180	◆◆◆	◆◆◆	◆◆◆	259	189	142	109	86	69	56	46	38	32	28	24	

See footnotes on page 146.

Shallow VERCOR™

- 36/4 Screw Pattern at Supports
#12 or #14 SDI Recognized Screws
to Supports 0.0385" and thicker
- Sidelaps Connected with #10 Screws



Allowable Diaphragm Shear Strength, q (plf) and Flexibility Factors, F ((in./lb)x10⁶)

DECK GAGE	SIDELAP FASTENER SPACING	SPAN (ft-in.)								
		1'-0"	1'-6"	2'-0"	2'-6"	3'-0"	3'-6"	4'-0"		
26	(none)	q	295	243	204	178	158	-	-	
		F	-53.8+1038R	-30.3+690R	-17.4+516R	-8.8+411R	-2.3+340R	-	-	
	#10 @ 12"	q	316	292	257	249	226	223	207	
		F	-55.4+1039R	-33.9+692R	-22.2+519R	-15.9+415R	-10.8+345R	-8+296R	-5+259R	
	#10 @ 8"	q	331	308	276	266	258	252	236	
		F	-56.2+1039R	-34.5+693R	-23.1+519R	-16.6+415R	-12.3+346R	-9.2+296R	-6.4+259R	
	#10 @ 6"	q	331	308	291	280	271	264	259	
		F	-56.2+1039R	-34.5+693R	-23.6+519R	-17.1+415R	-12.7+346R	-9.6+297R	-7.2+260R	
	#10 @ 4"	q	340	329	314	310	301	299	292	
		F	-56.6+1039R	-35.3+693R	-24.3+520R	-18+416R	-13.5+346R	-10.5+297R	-8.1+260R	
	24	(none)	q	394	324	273	237	211	-	-
			F	-22.9+503R	-10.7+334R	-3.6+249R	1.4+197R	5.4+163R	-	-
#10 @ 12"		q	426	397	352	343	313	311	289	
		F	-24.3+504R	-13.8+336R	-7.7+251R	-4.7+201R	-1.9+167R	-0.6+143R	1.1+125R	
#10 @ 8"		q	446	419	379	367	358	352	330	
		F	-25+504R	-14.4+336R	-8.5+252R	-5.3+201R	-3.2+168R	-1.7+144R	-0.1+126R	
#10 @ 6"		q	446	419	400	386	376	368	362	
		F	-25+504R	-14.4+336R	-9+252R	-5.7+201R	-3.6+168R	-2+144R	-0.8+126R	
#10 @ 4"		q	459	447	429	426	415	414	406	
		F	-25.4+504R	-15+336R	-9.6+252R	-6.5+202R	-4.3+168R	-2.8+144R	-1.6+126R	
22		(none)	q	493	406	342	297	264	-	-
			F	-10.9+287R	-3.3+190R	1.4+141R	4.9+111R	7.8+91R	-	-
	#10 @ 12"	q	536	504	449	441	403	403	375	
		F	-12.2+288R	-6+192R	-2.3+143R	-0.6+115R	1.2+95R	1.9+82R	3.1+71R	
	#10 @ 8"	q	563	532	484	471	462	454	428	
		F	-12.7+288R	-6.6+192R	-3+144R	-1.1+115R	0.1+96R	1+82R	2+72R	
	#10 @ 6"	q	563	532	510	495	484	475	468	
		F	-12.7+288R	-6.6+192R	-3.4+144R	-1.5+115R	-0.2+96R	0.7+82R	1.4+72R	
	#10 @ 4"	q	579	567	547	544	531	531	522	
		F	-13.1+288R	-7.1+192R	-4+144R	-2.2+115R	-0.9+96R	-0.1+82R	0.6+72R	

See footnotes on page 146.

Shallow VERCOR™

- 36/7 Screw Pattern at Supports
#12 or #14 SDI Recognized Screws
to Supports 0.0385" and thicker
- Sidelaps Connected with #10 Screws

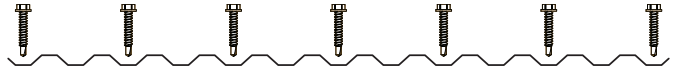

Allowable Diaphragm Shear Strength, q (plf) and Flexibility Factors, F ((in./lb)x10⁶)

DECK GAGE	SIDELAP ATTACHMENT	SPAN (ft-in.)								
		1'-0"	1'-6"	2'-0"	2'-6"	3'-0"	3'-6"	4'-0"		
26	(none)	q	499	383	311	272	232	-	-	
		F	-10+301R	-2.3+200R	2.3+148R	5.6+117R	8.3+97R	-	-	
	#10 @ 12"	q	540	464	386	369	319	315	282	
		F	-10.8+302R	-4.2+201R	-0.3+150R	1.6+120R	3.6+100R	4.4+85R	5.6+74R	
	#10 @ 8"	q	573	497	419	396	370	359	323	
		F	-11.3+302R	-4.7+201R	-0.9+150R	1.1+120R	2.5+100R	3.4+86R	4.5+75R	
	#10 @ 6"	q	573	497	448	422	393	380	362	
		F	-11.3+302R	-4.7+201R	-1.3+151R	0.7+120R	2.1+100R	3.1+86R	3.9+75R	
	#10 @ 4"	q	600	550	499	487	454	451	428	
		F	-11.6+302R	-5.2+201R	-1.9+151R	0+121R	1.4+100R	2.3+86R	3.1+75R	
	24	(none)	q	667	512	415	364	309	-	-
			F	-2.2+146R	2.1+96R	4.8+71R	7+56R	8.9+45R	-	-
#10 @ 12"		q	729	634	529	510	443	440	394	
		F	-2.9+146R	0.4+97R	2.6+72R	3.6+58R	4.8+48R	5.2+41R	6+36R	
#10 @ 8"		q	777	682	578	551	518	505	456	
		F	-3.4+146R	0+97R	2.1+73R	3.1+58R	3.8+48R	4.3+41R	5+36R	
#10 @ 6"		q	777	682	621	588	552	535	512	
		F	-3.4+146R	0+97R	1.7+73R	2.8+58R	3.5+48R	4+41R	4.5+36R	
#10 @ 4"		q	815	757	693	681	639	637	608	
		F	-3.6+146R	-0.5+98R	1.2+73R	2.2+58R	2.9+49R	3.3+42R	3.8+36R	
22		(none)	q	834	640	519	455	387	-	-
			F	0.5+83R	3.4+54R	5.4+40R	7+31R	8.5+25R	-	-
	#10 @ 12"	q	920	809	677	656	571	570	512	
		F	-0.1+83R	1.9+55R	3.4+41R	4+33R	4.8+27R	5+23R	5.7+20R	
	#10 @ 8"	q	984	873	743	712	674	659	596	
		F	-0.5+83R	1.5+55R	2.9+41R	3.6+33R	4+27R	4.3+23R	4.8+20R	
	#10 @ 6"	q	984	873	801	762	719	699	672	
		F	-0.5+88R	1.5+55R	2.6+41R	3.3+33R	3.7+28R	4.1+24R	4.3+21R	
	#10 @ 4"	q	1034	970	894	882	832	832	796	
		F	-0.7+84R	1.1+56R	2.2+42R	2.7+33R	3.2+28R	3.4+24R	3.7+21R	

See footnotes on page 146.

Shallow VERCOR™

- 36/9 Screw Pattern at Supports
#12 or #14 SDI Recognized Screws
to Supports 0.0385" and thicker
- Sidelaps Connected with #10 Screws



Allowable Diaphragm Shear Strength, q (plf) and Flexibility Factors, F ((in./lb)x10⁶)

DECK GAGE	SIDELAP ATTACHMENT	SPAN (ft-in.)								
		1'-0"	1'-6"	2'-0"	2'-6"	3'-0"	3'-6"	4'-0"		
26	(none)	q	696	542	443	390	332	-	-	
		F	-4.9+205R	0.3+136R	3.5+101R	5.8+80R	7.7+66R	-	-	
	#10 @ 12"	q	733	620	516	484	419	408	364	
		F	-5.4+205R	-0.8+137R	2+102R	3.5+81R	4.9+68R	5.5+58R	6.5+50R	
	#10 @ 8"	q	765	654	549	513	471	454	407	
		F	-5.7+205R	-1.1+137R	1.6+102R	3.1+82R	4.1+68R	4.8+58R	5.6+51R	
	#10 @ 6"	q	765	654	580	540	495	475	447	
		F	-5.7+205R	-1.1+137R	1.3+102R	2.8+82R	3.8+68R	4.5+58R	5.1+51R	
	#10 @ 4"	q	792	710	634	611	562	554	520	
		F	-5.9+206R	-1.5+137R	0.9+103R	2.2+82R	3.2+68R	3.8+59R	4.4+51R	
	24	(none)	q	929	724	591	520	444	-	-
			F	-0.1+99R	2.8+65R	4.8+48R	6.3+38R	7.6+31R	-	-
#10 @ 12"		q	986	842	703	665	576	564	504	
		F	-0.5+99R	1.9+66R	3.5+49R	4.3+39R	5.2+32R	5.5+28R	6.1+24R	
#10 @ 8"		q	1033	892	753	707	654	633	569	
		F	-0.7+100R	1.6+66R	3.1+49R	3.9+39R	4.5+33R	4.9+28R	5.4+24R	
#10 @ 6"		q	1033	892	798	747	690	665	629	
		F	-0.7+100R	1.6+66R	2.9+49R	3.7+39R	4.2+33R	4.6+28R	4.9+24R	
#10 @ 4"		q	1073	974	877	850	787	779	735	
		F	-0.9+100R	1.3+66R	2.5+50R	3.2+40R	3.7+33R	4+28R	4.4+25R	
22		(none)	q	1162	905	739	651	555	-	-
			F	1.5+56R	3.5+37R	4.9+27R	6+21R	7.1+17R	-	-
	#10 @ 12"	q	1241	1069	895	851	739	727	650	
		F	1.1+57R	2.6+37R	3.7+28R	4.2+22R	4.9+18R	5.1+16R	5.6+13R	
	#10 @ 8"	q	1305	1136	962	909	846	820	739	
		F	0.9+57R	2.4+38R	3.4+28R	3.9+22R	4.3+18R	4.5+16R	4.9+14R	
	#10 @ 6"	q	1305	1136	1024	962	894	863	820	
		F	0.9+57R	2.4+38R	3.2+28R	3.7+22R	4+19R	4.3+16R	4.5+14R	
	#10 @ 4"	q	1357	1244	1129	1099	1023	1015	962	
		F	0.8+57R	2.1+38R	2.8+28R	3.2+23R	3.6+19R	3.8+16R	4+14R	

See footnotes on page 146.

Shallow VERCOR™

- 36/13 Screw Pattern at Supports
#12 or #14 SDI Recognized Screws
to Supports 0.0385" and thicker
- Sidelaps Connected with #10 Screws

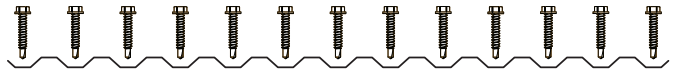

Allowable Diaphragm Shear Strength, q (plf) and Flexibility Factors, F ((in./lb)x10⁶)

DECK GAGE	SIDELAP ATTACHMENT	SPAN (ft-in.)								
		1'-0"	1'-6"	2'-0"	2'-6"	3'-0"	3'-6"	4'-0"		
26	(none)	q	880	652	520	453	383	-	-	
		F	6.5+12R	7.6+7R	8.6+5R	9.6+3R	10.5+2R	-	-	
	#10 @ 12"	q	935	752	607	562	478	463	409	
		F	6.2+12R	6.9+8R	7.6+6R	7.9+4R	8.4+3R	8.6+3R	9+2R	
	#10 @ 8"	q	985	798	647	596	539	515	457	
		F	6+12R	6.6+8R	7.3+6R	7.6+4R	7.8+4R	8+3R	8.3+2R	
	#10 @ 6"	q	985	798	687	629	568	541	503	
		F	6+12R	6.6+8R	7+6R	7.3+5R	7.6+4R	7.7+3R	7.9+3R	
	#10 @ 4"	q	1029	881	760	722	651	637	591	
		F	5.9+12R	6.3+8R	6.7+6R	6.8+5R	7.1+4R	7.1+3R	7.3+3R	
	24	(none)	q	1175	871	694	605	511	-	-
			F	5.3+6R	6.2+3R	7+2R	7.7+1R	8.5+0R	-	-
#10 @ 12"		q	1260	1024	827	771	658	640	567	
		F	5+6R	5.5+4R	6.1+2R	6.3+2R	6.7+1R	6.8+1R	7.2+1R	
#10 @ 8"		q	1334	1092	889	823	750	720	639	
		F	4.9+6R	5.3+4R	5.8+2R	6+2R	6.2+1R	6.3+1R	6.6+1R	
#10 @ 6"		q	1334	1092	948	873	794	758	709	
		F	4.9+6R	5.3+4R	5.6+3R	5.8+2R	6+2R	6.1+1R	6.2+1R	
#10 @ 4"		q	1400	1215	1057	1012	918	903	841	
		F	4.7+6R	5+4R	5.3+3R	5.4+2R	5.6+2R	5.6+1R	5.7+1R	
22		(none)	q	1471	1090	869	757	640	-	-
			F	4.5+3R	5.2+1R	5.9+1R	6.6+0R	7.2-1R	-	-
	#10 @ 12"	q	1588	1302	1054	988	844	825	731	
		F	4.2+3R	4.6+2R	5.1+1R	5.3+1R	5.7+0R	5.7+0R	6.1+0R	
	#10 @ 8"	q	1690	1396	1139	1060	971	935	831	
		F	4.1+3R	4.4+2R	4.8+1R	5+1R	5.2+1R	5.3+0R	5.6+0R	
	#10 @ 6"	q	1690	1396	1220	1128	1031	988	928	
		F	4.1+3R	4.4+2R	4.7+1R	4.8+1R	5+1R	5.1+1R	5.2+0R	
	#10 @ 4"	q	1778	1561	1367	1316	1200	1184	1107	
		F	3.9+3R	4.2+2R	4.4+1R	4.5+1R	4.6+1R	4.6+1R	4.7+1R	

See footnotes on page 146.

Deep VERCOR™

- 36/5 Screw Pattern at Supports
#12 or #14 SDI Recognized Screws
to Supports 0.0385" and thicker
- Sidelaps Connected with #10 Screws

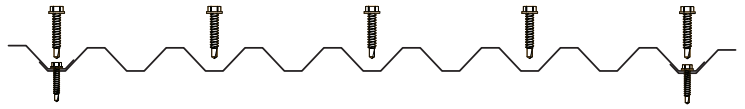

Allowable Diaphragm Shear Strength, q (plf) and Flexibility Factors, F ((in./lb)x10⁶)

DECK GAGE	SIDELAP ATTACHMENT	SPAN (ft-in.)							
		4'-0"	5'-0"	6'-0"	7'-0"	8'-0"	9'-0"	10'-0"	
26	#10 @ 24"	q	214	197	165	157	137	135	122
		F	-4.2+280R	-0.8+224R	3+186R	4.4+159R	6.8+139R	7.4+124R	9.2+111R
	#10 @ 18"	q	237	216	185	175	168	149	147
		F	-5.8+281R	-2.1+225R	1.5+187R	3.1+160R	4.3+140R	6.2+124R	6.9+112R
	#10 @ 12"	q	259	235	218	205	195	187	181
		F	-6.8+281R	-3+225R	-0.4+187R	1.4+161R	2.8+140R	3.9+125R	4.8+112R
	#10 @ 6"	q	332	314	301	292	284	278	273
		F	-8.8+282R	-5.2+226R	-2.8+188R	-1.1+161R	0.2+141R	1.2+125R	2+113R
24	#10 @ 24"	q	287	267	227	220	191	189	170
		F	1.9+144R	3.7+115R	6.2+95R	6.8+82R	8.5+71R	8.7+63R	10+57R
	#10 @ 18"	q	321	295	253	243	235	209	207
		F	0.6+145R	2.6+115R	4.8+96R	5.7+82R	6.3+72R	7.6+64R	7.9+57R
	#10 @ 12"	q	353	322	301	285	272	263	255
		F	-0.3+145R	1.8+116R	3.2+96R	4.2+83R	5+72R	5.6+64R	6.1+58R
	#10 @ 6"	q	454	433	418	406	397	390	384
		F	-2.1+146R	-0.2+116R	1.1+97R	2+83R	2.7+73R	3.2+65R	3.6+58R
22	#10 @ 24"	q	365	342	292	285	250	249	223
		F	4.1+84R	5.1+67R	7+55R	7.3+48R	8.6+41R	8.6+37R	9.7+33R
	#10 @ 18"	q	411	380	326	315	306	276	273
		F	2.9+85R	4.1+68R	5.8+56R	6.3+48R	6.7+42R	7.7+37R	7.8+33R
	#10 @ 12"	q	452	416	390	371	356	345	335
		F	2.1+85R	3.4+68R	4.3+56R	5+48R	5.5+42R	5.9+38R	6.2+34R
	#10 @ 6"	q	583	559	542	529	519	511	504
		F	0.5+86R	1.7+68R	2.5+57R	3+49R	3.4+43R	3.7+38R	4+34R
20	#10 @ 24"	q	445	420	359	353	313	313	280
		F	4.9+54R	5.6+43R	7.1+35R	7.2+30R	8.4+26R	8.3+23R	9.2+21R
	#10 @ 18"	q	503	469	403	391	382	344	341
		F	3.8+54R	4.7+43R	6+36R	6.3+31R	6.5+27R	7.4+24R	7.5+21R
	#10 @ 12"	q	556	514	485	462	445	432	421
		F	3.1+55R	4+44R	4.7+36R	5.1+31R	5.5+27R	5.7+24R	6+22R
	#10 @ 6"	q	717	691	671	657	646	637	629
		F	1.7+55R	2.4+44R	2.9+37R	3.3+31R	3.6+28R	3.8+24R	4+22R

See footnotes on page 146.

Deep VERCOR™ (Inverted)

- 36/4 Screw Pattern at Supports
- Sidelaps Connected with #10 Screws

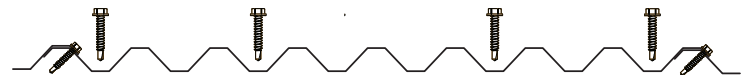

1. To obtain allowable diaphragm shear strength and flexibility factors for Deep VERCOR (Inverted) using a 36/4 screw pattern at supports, multiply values listed for Deep VERCOR using a 36/5 screw pattern at supports by the following adjustment factors:

Adjustment Factor	Sidelap Fastener Spacing			
	24" o.c.	18" o.c.	12" o.c.	6" o.c.
R _q	0.81	0.84	0.87	0.92
R _F	1.47	1.47	1.47	1.47

2. These adjustment factors are based on the maximum adjustment for the tabulated span lengths and fastener patterns. To calculate a specific condition, use design equations listed at the end of Evaluation Report ER-0217.

Deep VERCOR™

- 36/9 Screw Pattern at Supports
#12 or #14 SDI Recognized Screws
to Supports 0.0385" and thicker
- Sidelaps Connected with #10 Screws

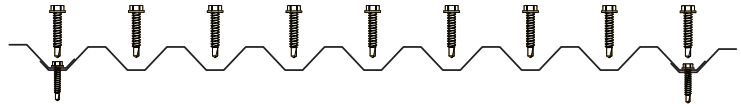

Allowable Diaphragm Shear Strength, q (plf) and Flexibility Factors, F ((in./lb)x10⁶)

DECK GAGE	SIDELAP ATTACHMENT	SPAN (ft.-in.)							
		4'-0"	5'-0"	6'-0"	7'-0"	8'-0"	9'-0"	10'-0"	
26	#10 @ 24"	q	305	268	222	206	180	173	156
		F	10.8+6R	11.1+5R	12.4+3R	12.5+3R	13.5+2R	13.4+2R	14.4+1R
	#10 @ 18"	q	332	293	242	224	210	187	181
		F	9.9+7R	10.3+5R	11.4+4R	11.6+3R	11.7+3R	12.6+2R	12.6+2R
	#10 @ 12"	q	359	314	284	259	241	228	218
		F	9.2+7R	9.7+6R	10.1+4R	10.4+4R	10.6+3R	10.8+3R	11+2R
	#10 @ 6"	q	457	418	390	370	355	343	279
		F	7.7+8R	8+6R	8.2+5R	8.3+4R	8.4+4R	8.5+3R	8.6+3R
24	#10 @ 24"	q	407	364	302	283	246	238	215
		F	9+3R	9.3+2R	10.4+1R	10.4+1R	11.3+0R	11.2+0R	12+0R
	#10 @ 18"	q	447	397	333	310	292	259	251
		F	8.2+3R	8.6+2R	9.5+1R	9.7+1R	9.8+1R	10.5+0R	10.5+0R
	#10 @ 12"	q	486	429	390	362	338	320	306
		F	7.6+3R	8+2R	8.3+2R	8.6+2R	8.8+1R	8.9+1R	9.1+1R
	#10 @ 6"	q	629	579	545	520	500	485	413
		F	6.4+4R	6.5+3R	6.7+2R	6.8+2R	6.9+2R	6.9+2R	7+1R
22	#10 @ 24"	q	515	464	387	366	319	310	278
		F	7.8+1R	8+1R	9+0R	9+0R	9.8-1R	9.8-1R	10.5-1R
	#10 @ 18"	q	569	509	430	402	382	338	328
		F	7.1+1R	7.4+1R	8.2+0R	8.3+0R	8.4+0R	9.1+0R	9.1+0R
	#10 @ 12"	q	622	553	505	470	444	422	404
		F	6.6+2R	6.9+1R	7.2+1R	7.4+1R	7.5+0R	7.7+0R	7.8+0R
	#10 @ 6"	q	813	754	713	683	659	641	567
		F	5.4+2R	5.6+2R	5.7+1R	5.7+1R	5.8+1R	5.9+1R	5.9+1R
20	#10 @ 24"	q	625	568	477	453	395	386	346
		F	6.9+0R	7.1+0R	8-1R	8-1R	8.8-1R	8.7-1R	9.3-1R
	#10 @ 18"	q	695	625	528	500	477	422	411
		F	6.3+1R	6.5+0R	7.3+0R	7.4+0R	7.5+0R	8.1+0R	8.1+0R
	#10 @ 12"	q	763	682	626	585	553	529	509
		F	5.8+1R	6.1+0R	6.3+0R	6.5+0R	6.7+0R	6.8+0R	6.9+0R
	#10 @ 6"	q	1006	938	891	856	829	807	738
		F	4.7+1R	4.9+1R	4.9+1R	5+1R	5.1+1R	5.1+0R	5.2+0R

See footnotes on page 146.

Deep VERCOR™ (Inverted)

- 36/8 Screw Pattern at Supports
- Sidelaps Connected with #10 Screws

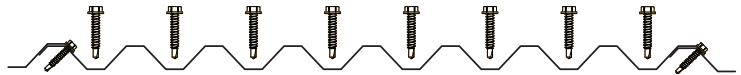

1. To obtain allowable diaphragm shear strength and flexibility factors for Deep VERCOR (Inverted) using a 36/8 screw pattern at supports, multiply values listed for Deep VERCOR using a 36/9 screw pattern at supports by the following adjustment factors:

Adjustment Factor	Sidelap Fastener Spacing			
	24" o.c.	18" o.c.	12" o.c.	6" o.c.
R _q	0.75	0.79	0.81	0.87
R _F	1.08	1.06	1.05	1.02

2. These adjustment factors are based on the maximum adjustment for the tabulated span lengths and fastener patterns. To calculate a specific condition, use design equations listed at the end of Evaluation Report ER-0217.

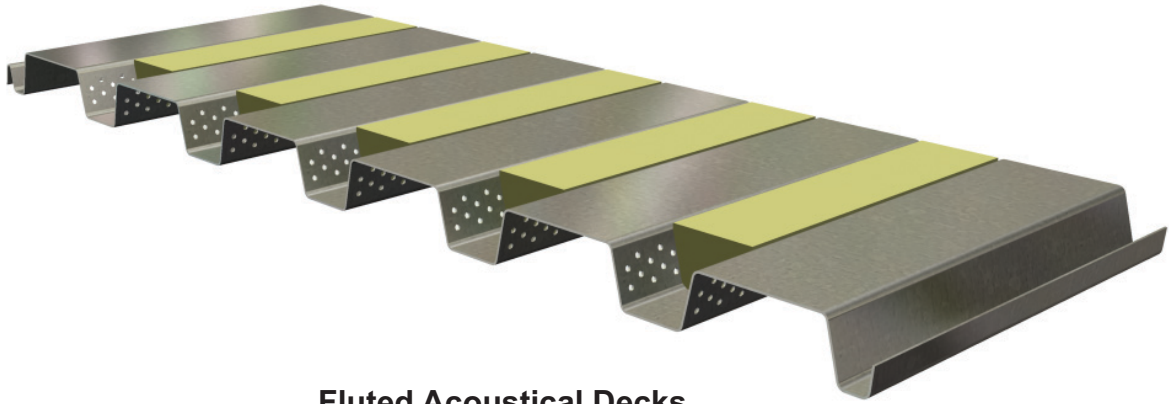

Fluted Acoustical Decks

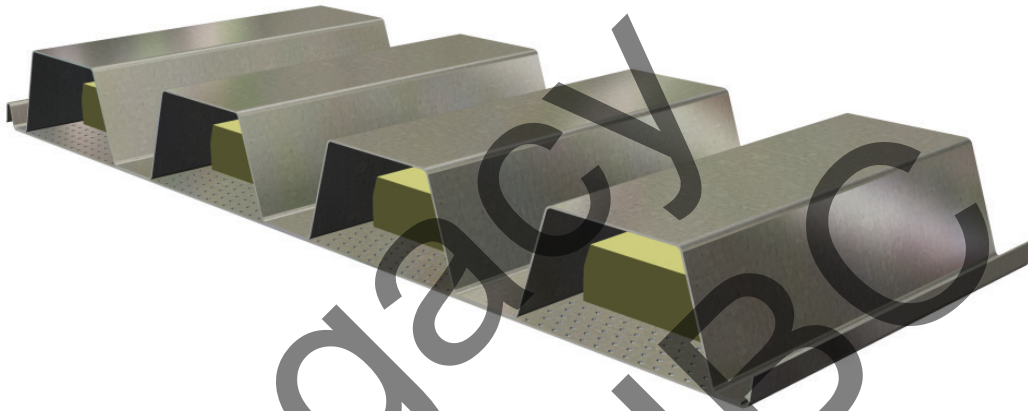

Cellular Acoustical Decks

ACOUSTIC / FACTORY MUTUAL (FM) / FIRE (UL) CONTENTS

Acoustical Roof Deck	156-159
Fluted Acoustical Deck	156
Fully Perforated Deck	157
Cellular Acoustical Deck	157
Roof Insulation	157
Acoustical Insulation	157
Noise Reduction Coefficients	157
Sound Transmission	159
Appearance	159
Factory Mutual	159-160
Fire-Rated Verco Roof Deck	161

ACOUSTICAL ROOF DECK

Verco 1½” and 3” deep fluted and cellular roof decks are available as acoustical decks. Acoustical deck can provide sound attenuation within buildings where the deck is exposed to the interior. Acoustical uses are limited to non-fire-rated assemblies.

Fluted Acoustical Deck

PLB-36, HSB-36, PLN3, HSN3, PLN-24 and N-24 fluted decks are available with acoustical perforations in the webs. The webs adjacent to the sidelaps of the PLB-36 and HSB-36 are not perforated as shown in Figure 15. Acoustical perforations are 5/32 inch in diameter on 7/16 staggered centers. The roofing contractor should install the acoustical insulation batts in fluted acoustical deck before placement of the roof insulation as shown in Figure 15. The web perforations have some impact on the deck section properties (vertical loads), allowable reactions due to web crippling, and diaphragm shear and flexibility, as shown on pages 26 and 28, 80 and 82, and 104 and 106.

Acoustic Insulation Placement

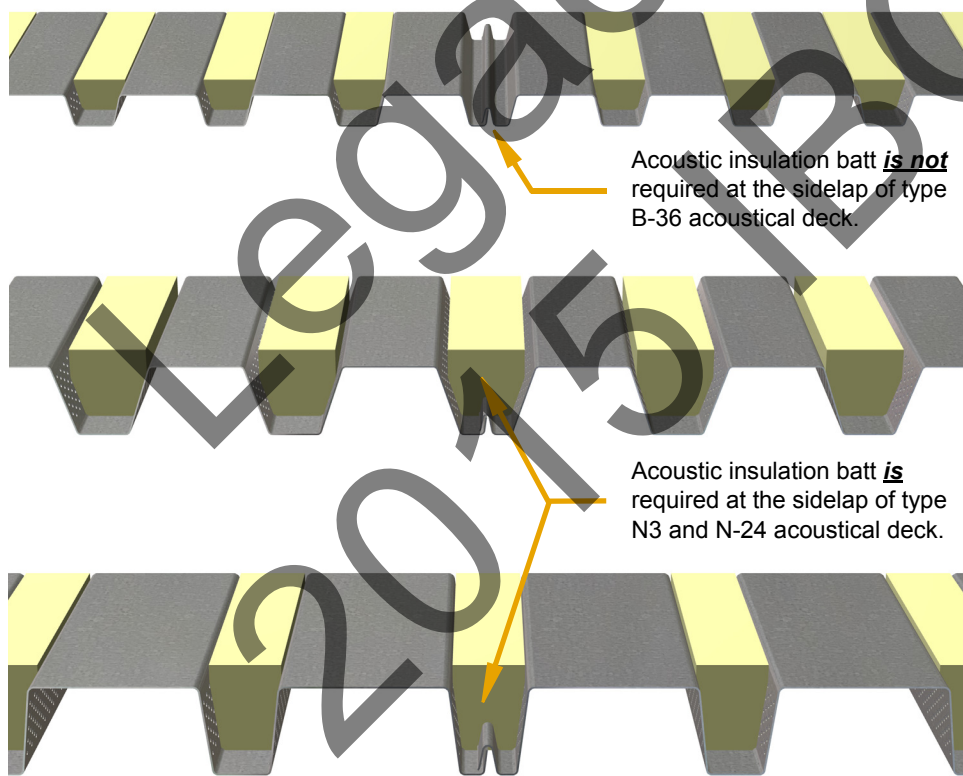

FIGURE 15

Fully Perforated Deck

The fluted profiles are also available fully perforated with the perforations across the entire section except for the sidelaps. Contact your Verco representative for availability.

Cellular Acoustical Deck

PLB-36-CD, HSB-36-CD, PLN3-CD, HSN3-CD, PLN-24-CD and N-24-CD cellular decks are available with acoustical perforations in the flat bottom plate. Acoustical perforations are 5/32 inch in diameter on 7/16 staggered centers in bands centered under the top flanges of the fluted top sections. The insulation batts in acoustical cellular deck are factory installed as shown in Figure 16. The perforations in the flat bottom plates have some impact on the deck section properties (vertical loads) and diaphragm shear and flexibility as shown on pages 124 thru 127.

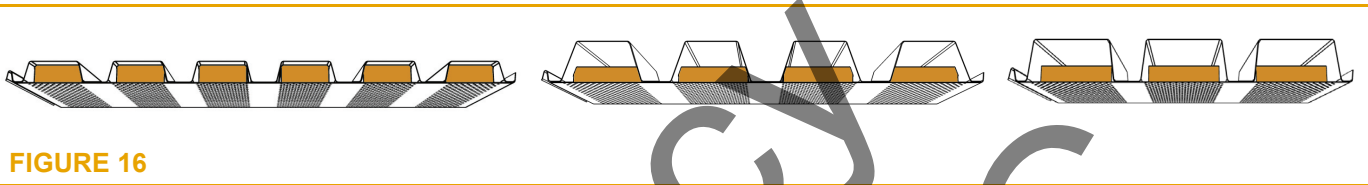

Roof Insulation

The performance of acoustical decks may be affected by the type of insulation placed above the deck. Acoustical performance data for fluted decks is shown with the historically used rigid fiberglass insulation board, polyisocyanurate insulation (poly-iso) board, and with roof board. The choice of insulation placed above the deck has minimal impact on the acoustical performance of cellular deck therefore only polyisocyanurate insulation is used in the cellular deck assemblies.

Acoustical Insulation

The acoustical insulation batts used in fluted or cellular acoustical decks are available encapsulated (wrapped) as a special order. Optional spacers may be installed in cellular acoustical decks between the flat bottom plate and the insulation batts. The acoustical performance of fluted decks with wrapped insulation batts and cellular acoustical decks with spacers are available from the Verco website at www.vercodeck.com.

Noise Reduction Coefficients

Tables 7 and 8 summarize the sound absorption coefficients for fluted and cellular decks at a number of frequencies. The complete acoustical test reports with the full range of absorption coefficients are available from the Verco website. The noise reduction coefficient (NRC) historically reported is the average of the coefficients at 250, 500, 1000, and 2000 Hz expressed to the nearest integral multiple of 0.05. The sound absorption average (SAA) is the average of the sound absorption coefficients for the twelve one-third octave bands from 200 through 2500 Hz inclusive, rounded to the nearest 0.01.

Table 7 lists the noise reduction values for PLB-36, HSB-36, PLN3, HSN3, PLN-24 and N-24 fluted decks with web perforations or fully perforated.

Table 7: Noise Reduction Coefficients of Acoustical Deck

Profile	Roof Insulation	AC Insulation	Absorption Coefficients						SSA	NRC	RAL Test No.
			125 Hz	250 Hz	500 Hz	1000 Hz	2000 Hz	4000 Hz			
PLB-36 AC or HSB-36 AC	Fiberglass	Plain	0.69	1.29	1.11	0.71	0.41	0.22	0.85	0.90	A13-262
	Poly-iso	Plain	0.11	0.23	0.66	0.89	0.38	0.24	0.53	0.55	A13-220
	Roof Board	Plain	0.10	0.33	0.55	0.90	0.42	0.23	0.55	0.55	A14-047
PLN3 AC or HSN3 AC	Fiberglass	Plain	0.69	1.32	1.16	0.93	0.49	0.30	0.94	1.00	A13-265
	Poly-iso	Plain	0.18	0.44	0.86	0.94	0.51	0.36	0.66	0.70	A13-214
	Roof Board	Plain	0.21	0.45	0.77	0.87	0.5	0.32	0.63	0.65	A14-049
PLN-24 AC or N-24 AC	Fiberglass	Plain	0.81	1.27	1.11	0.81	0.47	0.32	0.91	0.90	A13-263
	Poly-iso	Plain	0.20	0.33	0.87	0.84	0.47	0.32	0.63	0.65	A13-226
	Roof Board	Plain	0.27	0.56	0.84	0.88	0.52	0.36	0.69	0.70	A14-048

NOTES:
 AC – fluted deck with perforated webs
 Roof Insulation – insulation board above the deck
 AC Insulation – insulation provided for installation in the deck flutes
 Plain – unwrapped fiberglass insulation batts without facing

Table 8 lists the noise reduction values for PLB-36-CD, HSB-36-CD, PLN3-CD, HSN3-CD, PLN-24-CD and N-24-CD cellular acoustical decks.

Table 8: Noise Reduction Coefficients of Acoustical Cellular Deck

Profile	Roof Insulation	AC Insulation	Absorption Coefficients						SSA	NRC	RAL Test No.
			125 Hz	250 Hz	500 Hz	1000 Hz	2000 Hz	4000 Hz			
PLB-CD AC or HSB-CD AC	Poly-iso	Plain	0.17	0.60	0.91	1.06	0.76	0.53	0.82	0.85	A13-251
	Poly-iso	Wrapped	0.34	0.53	0.76	0.55	0.40	0.33	0.57	0.55	A13-249
PLN3-CD AC or HSN3-CD AC	Poly-iso	Plain	0.58	0.70	1.16	0.93	0.79	0.63	0.90	0.90	A13-234
	Poly-iso	Wrapped	0.54	0.70	0.92	0.67	0.50	0.33	0.70	0.70	A13-237
PLN-24-CD AC or N-24-CD AC	Poly-iso	Plain	0.84	0.79	1.16	0.98	0.82	0.60	0.96	0.95	A04-143

NOTES:
 AC – cellular deck with perforated bands in flat bottom plate
 Plain – unwrapped fiberglass insulation batts without facing
 Wrapped – encapsulated fiberglass insulation batts

Sound Transmission

Sound transmission between spaces within a structure or between the exterior and interior of a building is a function of the mass of the floor or roof assembly, and thus is not greatly impacted by the choice of steel roof deck itself, with or without acoustical insulation.

Appearance

Acoustical decks are normally exposed to view, therefore it is appropriate to review the product appearance considerations described on page 15.

FACTORY MUTUAL



All Verco 1½" and 3" fluted and cellular roof deck profiles meet Factory Mutual (FM) Approvals as: STEEL ROOF DECKS; Class I fire; Class I-60, I-75, and I-90 Wind Uplift Rating; Live Load Deflections; and Foot Traffic Resistance of Insulation per FM Standard 4451. Allowable Spans based upon the most conservative considerations of FM Standard 4451 for live load deflection, and Class I-60, I-75, and I-90 Wind Uplift Rating related to deck bending and fastener pull-over are shown in Table 9 for the specified fluted decks, and Table 10 for cellular decks. (Note: Approved spans are measured center-to-center of support members. FM Standard 4451 limits deflection at L/240 for a 200 lb. point load at mid-span. The specific FM Approved above deck components and selected attachments should also be considered.)

FM Global's RoofNav program, available from their website (www.roofnav.fmglobal.com), may be searched using the company name, Verco, for steel deck. Please note that specific assemblies within RoofNav do not list specific steel decks so as not to unnecessarily restrict what can be used. For a more comprehensive and an expanded list of allowable spans based upon FM Standard 4451 for each Wind Uplift Rating Class I-60, I-75 and I-90 for Verco deck with specific FM Approved support connections and connection spacing are also available from the Verco website (www.vercodeck.com).

Table 9: Simplified FM Approved Spans (c-c) for the most conservative considerations of FM Standard 4451 for live load deflection, and Class I-60, I-75, and I-90 Wind Uplift Rating related to deck bending and fastener pull-over for 1½" and 3" Fluted Roof Decks

Gage	No. of Spans	PLB-36 or HSB-36		PLN3 or HSN3		PLN-24 or N-24	
		Plain	Acoustic	Plain	Acoustic	Plain	Acoustic
22	1	6'-0"	5'-11"	12'-1"	10'-10"	12'-3"	9'-0"
	2+	7'-4"	7'-4"	12'-6"	11'-11"	12'-4"	11'-10"
20	1	6'-8"	6'-8"	13'-6"	12'-1"	13'-7"	10'-1"
	2+	8'-1"	8'-0"	14'-1"	13'-6"	14'-0"	13'-4"
18	1	7'-10"	7'-9"	15'-10"	14'-1"	16'-0"	11'-11"
	2+	9'-4"	9'-3"	17'-3"	16'-6"	17'-0"	16'-3"
16	1	8'-10"	8'-9"	17'-11"	16'-0"	18'-3"	13'-4"
	2+	10'-4"	10'-4"	19'-9"	18'-11"	19'-3"	18'-6"

Note: FM Approved Spans are limited to L/240 deflection due to 200 lb point load at mid-span.

Table 10: Simplified FM Approved Spans (c-c) for the most conservative considerations of FM Standard 4451 for live load deflection, and Class I-60, I-75, and I-90 Wind Uplift Rating related to deck bending and fastener pull-over for 1½" and 3" Cellular Roof Decks

Gage	No. of Spans	PLB-36-CD or HSB-36-CD		PLN3-CD or HSN3-CD		PLN-24-CD or N-24-CD	
		Plain	Acoustic	Plain	Acoustic	Plain	Acoustic
20/20	1	9'-3"	9'-1"	17'-9"	17'-8"	15'-3"	13'-0"
	2	10'-10"	10'-9"	15'-0"	14'-11"	15'-1"	15'-1"
	3+	10'-10"	10'-9"	10'-8"	10'-8"	10'-8"	10'-8"
20/18	1	9'-7"	9'-6"	18'-9"	18'-6"	15'-6"	13'-10"
	2	11'-3"	11'-1"	14'-11"	14'-10"	15'-1"	15'-1"
	3+	11'-4"	11'-1"	10'-8"	10'-8"	10'-8"	10'-8"
18/20	1	10'-6"	10'-4"	19'-8"	19'-8"	18'-8"	14'-1"
	2	12'-4"	12'-1"	16'-0"	16'-0"	16'-0"	16'-0"
	3+	12'-4"	12'-1"	10'-8"	10'-8"	10'-8"	10'-8"
18/18	1	10'-11"	10'-9"	21'-2"	20'-9"	18'-11"	15'-7"
	2	12'-11"	12'-9"	16'-0"	16'-0"	16'-0"	16'-0"
	3+	12'-11"	12'-9"	10'-8"	10'-8"	10'-8"	10'-8"
18/16	1	11'-4"	11'-1"	21'-9"	21'-6"	19'-0"	16'-0"
	2	13'-4"	13'-1"	16'-0"	16'-0"	16'-0"	16'-0"
	3+	13'-4"	13'-1"	10'-8"	10'-8"	10'-8"	10'-8"
16/18	1	12'-0"	11'-10"	23'-2"	22'-11"	22'-0"	16'-9"
	2	14'-1"	13'-11"	16'-0"	16'-0"	16'-0"	16'-0"
	3+	10'-8"	10'-8"	10'-8"	10'-8"	10'-8"	10'-8"
16/16	1	12'-6"	12'-3"	24'-0"	23'-9"	22'-3"	17'-8"
	2	14'-7"	14'-6"	16'-0"	16'-0"	16'-0"	16'-0"
	3+	10'-8"	10'-8"	10'-8"	10'-8"	10'-8"	10'-8"

Note: FM Approved Spans are limited to L/240 deflection due to 200 lb point load at mid-span.

Fire-Rated Verco Roof Deck (UL)



Verco roof decks may be used in assemblies which are required to meet hourly fire ratings. Approved hourly fire rated assemblies are a combination of specific proprietary materials as listed in the UL fire resistance directory.

Refer to Table 11 below for a listing of UL fire-rated assemblies utilizing Verco roof deck profiles. Refer to the particular UL assembly being considered for full details of construction, including specific information about fill or fireproofing thicknesses and span limitations.

ROOF DECK FIRE RESISTANCE RATINGS

Table 11 2, 3, 4, 6, 7

RESTRAINED ASSEMBLY RATING (hr)	UL #	FRAME	SYSTEM	DECK ¹					PROTECTED ⁵
				B	N3	N24	W2	VERCOR	
1-1½	P225	Beam/Joist	Deck/Board	✓	✓	✓			AC Ceiling
1-1½	P230	Beam/Joist	Deck/Board	✓					AC Ceiling
1-3	P518	CFS	Deck/Board	✓				✓	Gyp Board
¾-2	P701	Beam/Joist	Deck/Board	✓	✓	✓			SFRM
1-2	P711	Beam/Joist	Deck/Board	✓	✓	✓			SFRM
1-2	P717	Beam/Joist	Deck/Board	✓	✓	✓			SFRM
1-3	P719	Beam/Joist	Deck/Board	✓	✓	✓	✓		SFRM
1-3	P723	Beam/Joist	Deck/Board	✓	✓	✓	✓		SFRM
¾-2	P726	Beam/Joist	Deck/Board	✓	✓	✓			SFRM
1-3	P732	Beam/Joist	Deck/Board	✓	✓	✓			SFRM
¾-2	P734	Beam/Joist	Deck/Board	✓	✓	✓			SFRM
1-2	P739	Beam/Joist	Deck/Board	✓	✓	✓			SFRM
1-2	P740	Beam/Joist	Deck/Board	✓	✓	✓			SFRM
1-2	P741	Beam/Joist	Deck/Board	✓	✓	✓			SFRM
1-2	P742	Beam/Joist	Deck/Board	✓	✓	✓			SFRM
1-2	P743	Beam/Joist	Deck/Board	✓	✓	✓			SFRM
¾-2	P748	Beam/Joist	Deck/Board	✓	✓	✓			SFRM
1-3	P750	Beam/Joist	Deck/Board	✓	✓	✓	✓		SFRM
1-3	P751	Beam/Joist	Deck/Board	✓	✓	✓	✓		SFRM
1-2	P819	Beam/Joist	Deck/Board	✓	✓	✓			SFRM
1-2	P829	Beam/Joist	Deck/Board	✓	✓	✓			SFRM
1-2	P837	Beam/Joist	Deck/Board	✓	✓	✓			SFRM
1-2	P838	Beam/Joist	Deck/Board	✓	✓	✓			SFRM

(continued on next page)

Table 11 (continued)

RESTRAINED ASSEMBLY RATING (hr)	UL #	FRAME	SYSTEM	DECK ¹					PROTECTED ⁵
				B	N3	N24	W2	VERCOR	
1-2	P907	Beam/Joist	Insulating Concrete					✓	No
1-2	P908	Beam/Joist	Insulating Concrete					✓	No
1-2	P920	Beam/Joist	Insulating Concrete	✓	✓	✓	✓		No
1-2	P921	Beam/Joist	Insulating Concrete	✓	✓	✓	✓	✓	No
1-2	P922	Beam/Joist	Insulating Concrete	✓	✓	✓	✓	✓	No
1-2	P923	Beam/Joist	Insulating Concrete	✓	✓	✓	✓	✓	No
1-2	P925	Beam/Joist	Insulating Concrete	✓	✓	✓	✓	✓	No
1-2	P926	Beam/Joist	Insulating Concrete					✓	No
1-2	P927	Beam/Joist	Insulating Concrete					✓	No
1-2	P928	Beam/Joist	Insulating Concrete	✓	✓	✓	✓	✓	No
1-2	P929	Beam/Joist	Insulating Concrete	✓	✓	✓	✓	✓	No
1-2	P930	Beam/Joist	Insulating Concrete	✓	✓	✓	✓	✓	No
1-2	P936	Beam/Joist	Insulating Concrete	✓	✓	✓	✓	✓	No
1-2	P937	Beam/Joist	Insulating Concrete	✓	✓	✓	✓	✓	No
1-2	P938	Beam/Joist	Insulating Concrete					✓	No
1-2	P939	Beam/Joist	Insulating Concrete	✓	✓	✓	✓	✓	No
1-2	P940	Beam/Joist	Insulating Concrete	✓	✓	✓	✓	✓	No
1-2	P943	Beam/Joist	Insulating Concrete					✓	No
1-2	P944	Beam/Joist	Insulating Concrete	✓	✓	✓	✓		No
1-2	P945	Beam/Joist	Insulating Concrete	✓	✓	✓	✓	✓	No
1-2	P947	Beam/Joist	Insulating Concrete	✓	✓	✓	✓	✓	No

1. "B" = PLB and HSB, PLB and B FORMLOK
 "N24" = PLN and N, PLN and N FORMLOK
 "N3" = PLN3 and HSN3, PLN3 and N3 FORMLOK
 "W2" = PLW2 and W2 FORMLOK
 "VERCOR" = 1 $\frac{5}{16}$ " Deep VERCOR
2. Refer to UL Fire Resistance Directory, Evaluation Reports for Verco Steel Deck, or municipality requirements for full details of construction including usage limitations and mesh requirements.
3. Also see various "unclassified" listings that may apply to Verco decks based on deck profile.
4. Code-compliant Verco gray primer paint is formulated for compatibility with spray-applied fireproofing. Verco steel decks in the protected assemblies listed above may be galvanized or painted, excluding assemblies P230, P726 and P748, which shall be galvanized only. Verco steel decks in the unprotected assemblies listed above shall be galvanized only. Galvanized decks with primer painted underside are not approved for use in fire-rated systems.
5. Protected assemblies have spray-applied fireproofing applied directly to the underside of the deck. Unprotected assemblies do not require spray-applied fireproofing applied to the underside of the deck.
 "AC Ceiling = Fire Rated Acoustical Ceiling system."
 "Gyp Board = UL Classified Gypsum Board."
 "SFRM = Spray-Applied Fire Resistive Materials."
6. Verco Decking, Inc. assumes no responsibility for adhesion of any spray-applied fireproofing material, nor for any treatment, cleaning, or surface preparation of the deck required for adhesion of fire protection material.
7. Sidelap fastening with the PunchLok® II Tool, button punches, or seam welds is required for fluted decks, except for P225, P518, P717, P719, P723, P732, P739, P741, P743, P750, P751, P819, P829, and P929, which also allow screws.

Metric (SI) Conversions

	US	Multiplied by	= Metric		US	Multiplied by	= Metric
Length	in.	x	25.4 = mm	Mass	oz	x	28.34952 = g
	in.	x	2.54 = cm		lb	x	0.4535924 = kg
	ft	x	304.8 = mm		plf	x	1.488164 = kg/m
	ft	x	30.48 = cm		psf	x	4.882428 = kg/m ²
	ft	x	0.3048 = m		pcf	x	16.01846 = kg/m ³
Area	in. ²	x	645.16 = mm ²	Force	lb	x	4.448222 = N
	in. ²	x	6.4516 = cm ²		plf	x	14.5939 = N/m
	ft ²	x	0.09290304 = m ²		psi	x	6.894757 = kN/m ²
Volume	in. ³	x	16,387.06 = mm ³		psf	x	47.88026 = N/m ²
	in. ³	x	16.38706 = cm ³		in.-lb (in.-kips)	x	0.1129848 = Nm (kNm)
	ft ³	x	0.02831685 = m ³	in.-lb/ft (in.-kips/ft)	x	0.3706850 = Nm/m (kNm/m)	
Moment of Inertia	in. ⁴	x	416231.4 = mm ⁴	Flexibility	in./lb x 10 ⁶	x	5.71015 = mm/N x 10 ⁶
	in. ⁴	x	41.62314 = cm ⁴		Galvanizing	oz/ft ²	x
	in. ⁴ /ft	x	1365588 = mm ⁴ /m	Paint		mil	x
	in. ⁴ /ft	x	136.5588 = cm ⁴ /m				
Section Modulus	in. ³ /ft	x	53763 = mm ³ /m				
	in. ³ /ft	x	53.763 = cm ³ /m				

Metric Definitions:

“m” - meter
 “cm” - centimeter
 “mm” - millimeter
 “g” - gram
 “kg” - kilogram
 “N” - Newton
 “Pa” - Pascal

Note: “Metric” is the common term used to refer to measurements denoted by the formal term “Standard International” or “SI.”

Conversion factors and notation as per IEEE/ASTM SI 10-2010 and common mathematical practices.

The PunchLok II tool and the method of using it are the subject of U.S. Patent No. 6,212,932, U.S. Patent No. 6,397,469 and/or U.S. Patent No. 8,667,656.

VERCO®, PUNCHLOK®, SHEARTRANZ®, and HSB®, are registered trademarks of Verco Decking, Inc. PLB™, PLN™, PLN3™, HSN3™, VERCOR™, and FORMLOK™ are trademarks of Verco Decking, Inc. All other names may be trademarks of their respective owners. All rights reserved.

VERCO DECKING, INC., reserves the right to change the design or details of its products without notice. The information in this catalog is presented for general information only and is not to be used or relied upon for any application without complete review of the proposed application and without a complete review by a licensed professional architect, engineer, designer or other qualified professional.

VERCO DECKING, INC. assumes no liability whatsoever for the accuracy or completeness of the information contained herein.

VERCO DECKING, INC., makes no representation or warranty of any kind, either express or implied, respecting any information contained in this catalog including, but not limited to, the accuracy, completeness or suitability of such information for any particular purpose or use.

In addition, VERCO DECKING, INC., expressly disclaims any liability for incidental, special, consequential or punitive damages including, but not limited to, loss of profits or loss of use.

VERCO DECKING, INC.'S liability, warranties and other obligations with respect to its decking products are set forth in the VERCO DECKING, INC. Terms and Conditions of Sale provided to Buyer in connection with the provision of such decking products.

As used herein, references to VERCO DECKING, INC., includes any parents, affiliates and subsidiaries.

INDEX

A

Accessories	21
Acoustical deck (fluted)	156
Acoustical deck (non-cellular)	156
Acoustical Insulation	157
Appearance	159
Attachment	
Button punches	13
Deep VERCOR™ Deck	145
Mechanical fasteners	10–11, 13
Parallel collectors	13–14
PLB™-36 or HSB®-36	27
PLB™-CD or HSB®-CD	124
PLN™-24 or HSN™-24	105
PLN™-24-CD or N-24-CD	126
PLN3™ or HSN3™	81
PLN3™-CD or HSN3™-CD	125
PunchLok® II System	11
Shallow VERCOR™ Deck	144
ShearTranz® II-42 System	11
Sidelaps	12–13
Supports	10–11
Tension strength	7–8
Welds	10, 13
Axial loads	9

B

Bearing	5–6
Button punches	13

C

Cantilevered deck	7
Cellular Acoustical Deck	157
Cellular Deck tables (q and F)	137–142
Closures	21
Concentrated loads	7
Construction loads	7

D

Deep VERCOR™ tables (q and F)	153–154
Design example	17–20
Design formulas	5
Diaphragm load tables	9
Diaphragm shear FORMLOK™ deck without fill	9
Dimensions	
Deep VERCOR™ Deck	145
PLB™-36 or HSB®-36	26
PLB™-CD or HSB®-CD	124
PLN™-24 or HSN™-24	104
PLN™-24-CD or N-24-CD	126
PLN3™ or HSN3™	80
PLN3™-CD or HSN3™-CD	125
Shallow VERCOR™ Deck	144

F

Factory Mutual	159
Finishes	15

Fire resistance ratings	20, 161
Fire-Rated Verco Roof Deck	161
Fluted acoustical deck	156
FORMLOK™ deck diaphragms	9
Fully Perforated Deck	157

G

Galvanized deck	15
Galvanized with primer	15

H

Hilti fasteners	10
PLB™-36 tables (q and F)	34–44
PLN™-24 tables (q and F)	109–111
PLN3™ tables (q and F)	85–87
How to use tables	23
HSB®-36 tables (q and F)	67–78
HSN3™ tables (q and F)	98–101

L

Loads	
Concentrated	7
Suspended	7
Vertical	5

M

Material	4
Metric conversions	163

N

N-24 tables (q and F)	122
Noise Reduction Coefficients	157

P

Parallel collector attachment	13–14
PLB™-36 tables (q and F)	30–64
PLN™-24 tables (q and F)	108–121
PLN3™ tables (q and F)	84–97
Pneutek fasteners	10
PLB™-36 tables (q and F)	45–60
PLN™-24 tables (q and F)	112–119
PLN3™ tables (q and F)	88–95
Primered deck	15

Profiles

Designations	4
Summary	2

Properties

Deep VERCOR™ Deck	145
PLB™-36 or HSB®-36	26
PLB™-CD or HSB®-CD	124
PLN™-24 or HSN™-24	104
PLN™-24-CD or N-24-CD	126
PLN3™ or HSN3™	80
PLN3™-CD or HSN3™-CD	125
Shallow VERCOR™ Deck	144
PunchLok® II System	11

R

Roof Insulation	157
Roofing	16

S

Screws	11, 13
HSB®-36-SS tables (q and F)	71–74
PLB™-36 tables (q and F)	61–64
PLN™-24 tables (q and F)	120–121
PLN3™ tables (q and F)	96–97
Shallow VERCOR™ tables (q and F)	149–154
Shallow VERCOR™ tables (q and F)	149–152
ShearTranz® II-42 System	11
Installation instructions	66
Tables (q and F)	65
Sidelap connections	12–13
Sound Transmission	159
Spans	16
Specification	22
Sump pan	22
Suspended loads	7

U

Uniform Load Tables	5
Cellular Deck	128–136
Deep VERCOR™	148
PLB™-36 and HSB®-36	29
PLN™-24 and N-24	107
PLN3™ and HSN3™	83
Shallow VERCOR™	147

V

Venting	16
---------	----

W

Weights	
Deep VERCOR™ Deck	145
PLB™-36 or HSB®-36	26
PLB™-CD or HSB®-CD	124
PLN™-24 or HSN™-24	104
PLN™-24-CD or N-24-CD	126
PLN3™ or HSN3™	80
PLN3™-CD or HSN3™-CD	125
Shallow VERCOR™ Deck	144
Welds	
Arc spot welds	10, 11
Cellular Deck tables (q and F)	137–142
Fillet welds	13
HSB®-36 tables (q and F)	67–70
HSN3™ tables (q and F)	98
N-24 tables (q and F)	122
PLB™-36 tables (q and F)	30–33
PLN™-24 tables (q and F)	108
PLN3™ tables (q and F)	84
ShearTranz® II-42 System	11
Top seam welds	10, 11, 13
Wind uplift	7–8

Verco can supply factory applied primer paint in standard gray, white, or custom colors over galvanized or cold rolled steel to meet your project requirements.

Depending on the circumstances, use of Verco factory primer painted deck can:

- Eliminate field painting
- Provide an excellent primer base for field finish paint

Use of the PunchLok II System compliments the benefits of the factory primer painted deck and increases the cost savings.

By offering a variety of both attachment and finish options, Verco provides the flexibility to combine finish and attachment options to minimize construction time and maximize project cost savings.

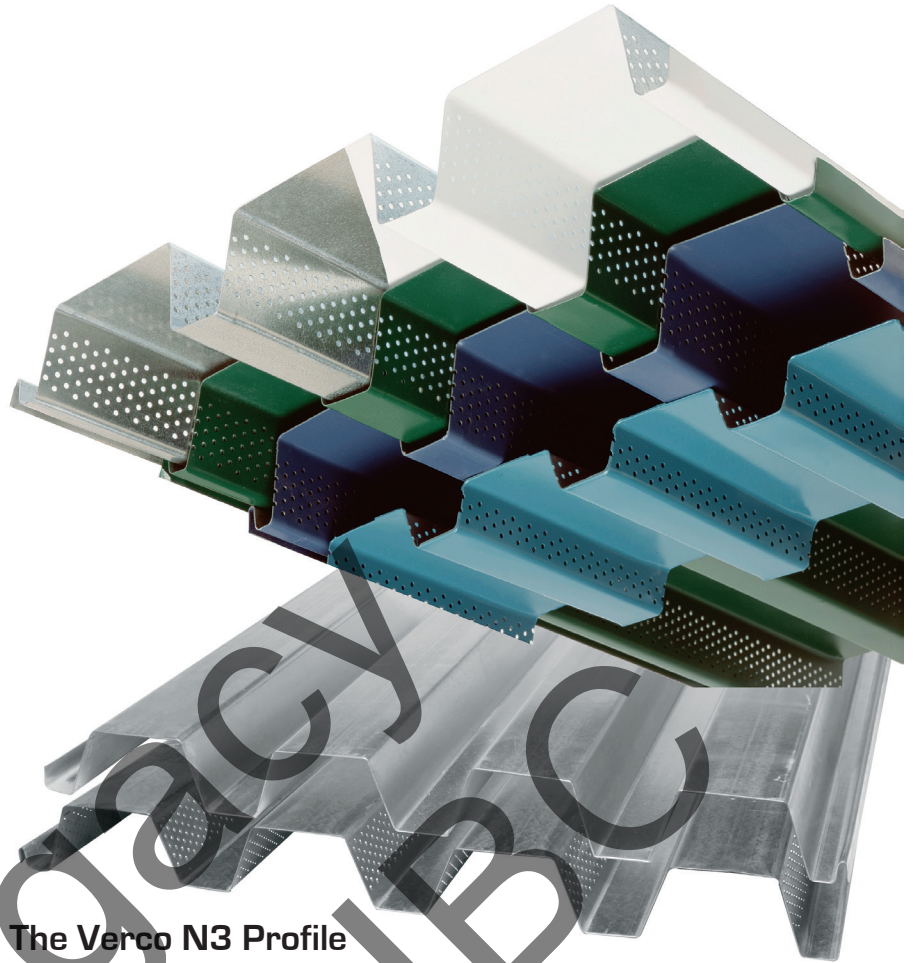

The Verco N3 Profile

Verco now offers two 3" deep roof deck options, N3 and N-24. The Verco N3 roof and floor deck profiles have a 32" cover width. This additional cover width results in fewer sheets to spread and less sidelaps to fasten. The N3 profile offers superb shear strength with fewer support and sidelap fasteners to install.



VERCO SIDELAP CONNECTION 2 (VSC2)

Building on the success of the industry changing PunchLok System, the Verco PunchLok II System provides an even stronger sidelap connection with the same benefits of the original PunchLok System including:

- Simple visual inspection, no gauges required
- Consistency from first punch to last punch of the day
- Efficient and easy to use
- Allows the use of Verco's factory applied custom color primer coating without weld damage

DIVISION HEADQUARTERS

4340 N. 42nd Avenue
Phoenix, Arizona 85019
Tel (602) 272-1347
www.vercodeck.com

DISTRICT SALES OFFICES

Northern California

Tel (916) 488-8180
Fax (916) 488-8099
NorthernCaliforniaSales@vercodeck.com

Southern California

Tel (714) 939-9128
Fax (714) 939-9109
SouthernCaliforniaSales@vercodeck.com

Phoenix – Arizona

Tel (623) 385-1649
Fax (623) 385-1660
PhoenixSales@vercodeck.com

Salt Lake City – Utah

Tel (801) 292-0730
Fax (801) 621-0927
SaltLakeCitySales@vercodeck.com

Seattle – Washington

Tel (425) 883-8250
Fax (425) 882-0134
SeattleSales@vercodeck.com

ENGINEERING OFFICES

Northern California
Seattle – Washington
Tel (510) 792-8370
Fax (510) 792-2429
VercoEngineeringNW@vercodeck.com

Southern California
Tel (714) 938-0307
Fax (714) 938-0340
VercoEngineeringSoCal@vercodeck.com

Phoenix – Arizona
Salt Lake City – Utah
Tel (623) 385-1651
Fax (623) 385-1660
VercoEngineeringPHX@vercodeck.com

MANUFACTURING PLANTS

Antioch, California
Fontana, California
Phoenix, Arizona

LITERATURE REQUEST

Fax (510) 792-2429
literature-request@vercodeck.com

PunchLok® II

S Y S T E M

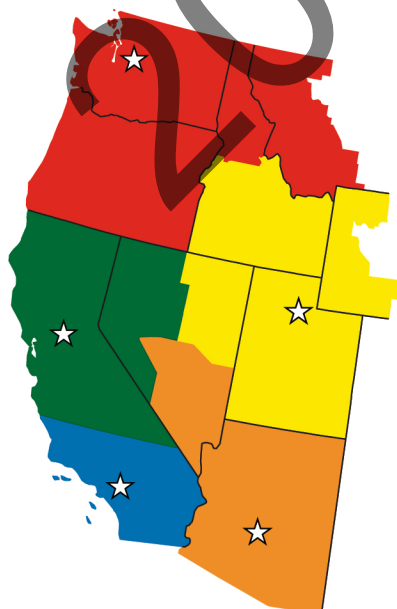
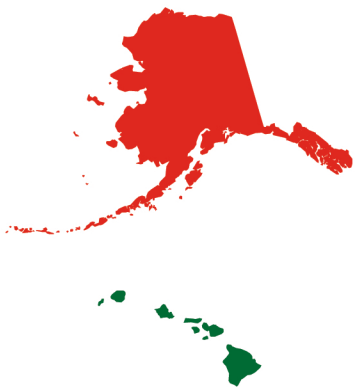

SALES TERRITORIES

VR4



LEVERAGING TECHNOLOGY. CREATING SOLUTIONS.